



**Jean Louis MENEGON**

Représentant et Conseiller  
Région Sud Ouest

**Tel : 06 76 08 96 83**

Email: [jlouismenegon@aol.com](mailto:jlouismenegon@aol.com)  
[www.menegon-metrologie.com](http://www.menegon-metrologie.com)

# METROLOGY 2015

In Germany at home – in demand worldwide



## **METROLOGY | 2015**

**In Germany at home – in demand worldwide**





**Jean Louis MENEGON - Votre représentant et Conseiller- Tél. : 06 76 08 96 83**  
E-mail: [jlouismenegon@aol.com](mailto:jlouismenegon@aol.com) - web: [www.menegon-metrologie.com](http://www.menegon-metrologie.com)

Dear **HELIOS-PREISSER** Customer,

One company, one team, many new aspects, to sum up the new chapter at HELIOS-PREISSER. We are marking our 75th anniversary by creating a new, even more service-oriented structure. Instead of holding a celebration for ourselves, we are carving out more benefits for our customers because we see our anniversary not only as an opportunity to look back at our past, but also more importantly a chance to position ourselves for the future by focusing on the most important thing we have: our customers. It is all of you who have made our success over the last 75 years possible and we want to express our gratitude by giving something back to you and becoming even more efficient in our collaboration with you. We have our own sales team, our own production facilities, and we train our own future employees to keep our tradition of service alive and shape our shared future.

**You can benefit from the refined blend of ...**

- our knowledge,
- our comprehensive expertise,
- our exemplary customer focus,
- our fast production, and
- our well-founded advice and tradition of quality.



**HELIOS · PREISSER**

You will find this blend again and again in this catalogue and you're also sure to discover some new things as well. Some things have not changed, though, because they are already optimal: our accountability, our consistency, and our company's straightforward way of working with you.

The 130 members of our team play an important part in this success on a day-to-day basis. We are proud of them and are pleased that there are many second and even third-generation family members who have joined our corporate family.

You can count on us in every respect to provide the best business transaction and open dialogue. With an even wider range of products, more service, and innovative electronic products, we are remaining true to you and to what we do best: portable measurement technology at its best.

**Siegfried Lorch**

Managing Director, Production

**Rainer Fahrenholz**

Managing Director, Sales



75 Years



**Ehren-Urkunde**

Handwerkskammer  
Reutlingen

Dem Betrieb  
**HELIOS-PREISSER GmbH**  
72501 Gammertingen

wird  
**zum 75-jährigen  
Betriebsjubiläum**  
diese Ehren-Urkunde verliehen.

Reutlingen, den 1. Januar 2015

  
Harald Herrmann  
Präsident

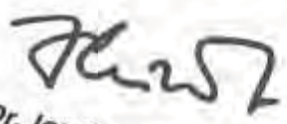
  
Dr. Joachim Eisert  
Hauptgeschäftsführer



## SUCCESS HAS A HISTORY AND AN EXCITING FUTURE ...

For 75 years, **HELIOS-PREISSER** has been a success story "made in Germany". We see the milestones of the past as signposts for the future: with a clear "yes" to a philosophy which favours Germany as our location, constant growth and a total focus on our customers' needs.

Time and time again, we have been able to refine and enrich what began 75 years ago, making a full range of products available to our customers, leaving nothing to be desired in the field of portable measurement technology, and leaving almost no questions unanswered. We have managed to achieve this by ...

### **Growth and investment:**

**1940:** founded by Albert Barth and Erich Preißer; **1951:** change of name to Erich Preißer & Co. Meßzeugfabrik; **1981:** growth leads to expansion of the company and necessitates relocation from Mägerkingen to Gammertingen; the new manufacturing facilities allow production to expand to an industrial scale.

### **Expansion and restructuring:**

**1990:** capacity once again expanded; **1995:** The manufacturing company FPH Meßzeugproduktion GmbH & Co. is founded jointly with Helios to address customer segments in a more targeted fashion with differentiated products; **1997:** PREISSER Messtechnik GmbH is created by managing shareholders Siegfried Lorch and Diethardt Preißer

### **Optimisation and reinforcement:**

**1998:** fundamental renewal of machinery and establishment of climate-controlled measurement laboratory; **2002:** acquisition of Messzeuggbau Sachsen GmbH with 15 employees; **2007:** the individual Helios, PREISSER and HOREX brands now engage in joint marketing through the sales centre in Gammertingen; **2011:** merger of the Helios and PREISSER brands; **2015:** all divisions merged to create HELIOS-PREISSER GmbH, located in Gammertingen, with an eye towards the future.

Our look back shows that we are on the right track and we look forward to continuing to be at your side as you journey towards future success.

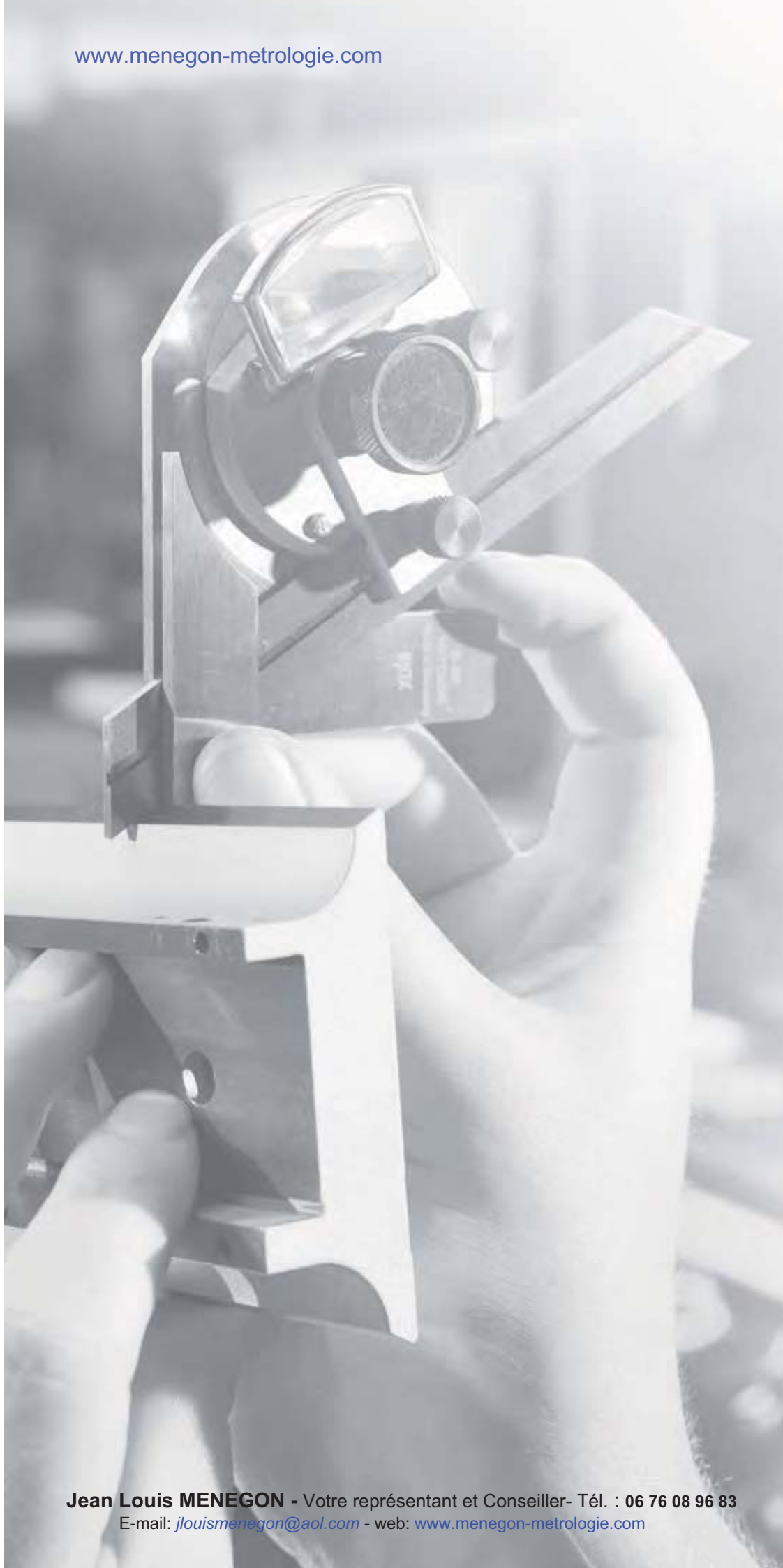



## IF IT SAYS **HELIOS-PREISSER**, YOU WILL FIND **TOP** **QUALITY** INSIDE

**This statement is as true for our overall product range as it is for individual items**

such as digital callipers, gauges and external micrometers. Whether universal or special, our options range from small, handy vernier digital pocket callipers to versatile, highly accurate comparators.

**What sets all of our products apart, regardless of variant, is their utmost precision and a very special strength:**

customisation according to your wishes.

**We offer the same quality in all other areas of portable measurement technology,**

including advice from experienced staff, problem solving, training, calibration... There's one thing you can completely rely on: anything displaying the **HELIOS-PREISSER** logo meets the highest standards. Guaranteed!









## KNOWLEDGE, EXPERTISE, AND CUSTOMER FOCUS ...

Are what's needed for extremely successful collaboration. But we wouldn't be **HELIOS-PREISSER** if we simply satisfied with that. So sometimes we turn the familiar upside down to see if this might produce additional benefits for you. The results speak for themselves ...



- premium quality from Gammertingen
- expansion of sales in Europe
- global consulting network of over 5,000 specialist dealers, who act as our partners in the field
- an extensive and full range of products for a wide variety of target groups
- individual solutions and custom-made products designed by professionals for professionals
- high degree of flexibility for custom designs or questions on production (hotline)
- online presence with corresponding service options
- comprehensive service, fast production, quick turnover
- balanced price/performance ratio
- calibration certificate included in many cases
- support activities such as consulting and training to ensure no questions about the portable measuring technology remain unanswered

**75 years young and feeling energised for the next 75 years:** you can expect a dynamic development in the future naturally focused on our three values: **knowledge, expertise and customer focus!**

**Jean Louis MENEGON** - Votre représentant et Conseiller- Tél. : 06 76 08 96 83  
E-mail: [jlouismenegon@aol.com](mailto:jlouismenegon@aol.com) - web: [www.menegon-metrologie.com](http://www.menegon-metrologie.com)



# CONTENTS CATALOGUE

1	Calipers	
2	Micrometers	
3	Dial gauges and Indicating instruments	
4	Marking instruments	
5	Squares, Protractors, Bevel protractors	
6	Inspection equipment, Standards, Rules	
7	Data transmission	
8	Calibration service, Order number index, Keyword index	

## QUALITY AND FLEXIBILITY MAKE THE DIFFERENCE

If portable measurement technology inspires, then this is usually because HELIOS-PREISSER is behind it, and it is almost always the precision products that do the inspiring. Because over the years our brand has evolved into a hallmark of a comprehensive premium range, enabling our customers to work with extreme precision, even when it comes to extremely fine measurements. This is just the sort of challenge that we tackle on a day-to-day basis with maximum customer orientation right up to custom-made products if that's what it takes to meet your needs.

We have 130 team members at our Gammertingen facility in the state of Baden-Württemberg, in the southwest corner of Germany. The benefits? Short lead times, long-term availability and quick solutions when you need them urgently.

Quality, of course, is no. 1 here and it goes by the name of DIN EN ISO 9001. These strict requirements for certification apply to everything from our design to manufacturing processes, from procurement from suppliers to our marketing and distribution. And it's also important that our team members have their head in the game and share our philosophy: this ensures that we are your high-precision partner in all respects.



# 1. CHAPTER CALIPERS

14	Pocket vernier calipers
21	Pocket calipers / Tyre profile depth gauge
22	Measuring tool sets
23	Pocket calipers with dial
25	Digital pocket calipers
31	Digital pocket calipers for specific measuring tasks
37	Vernier workshop calipers
44	Workshop caliper with dial / Lightweight workshop calipers
45	Analogue caliper with cross points / gripper points
46	Digital workshop calipers
58	Contraction vernier calipers
60	Calipers for external locking grooves
61	Brake drum vernier calipers / Brake disc inspection gauges
62	Calipers for internal locking grooves
63	Calipers for 3/5 point measurement / for milling tool setting
64	Chamfer / Radius gauges
65	Gear tooth calipers
66	Vernier depth gauges
70	Digital depth gauges
76	Digital depth gauges with interchangeable inserts
80	Digital depth gauge for one-handed operation
81	Digital mounting scales
82	Wooden cases



## 0184 / 0185 Pocket vernier calipers



### Specification

- Stainless steel
- Reading parts have a satin chrome finish
- DIN 862
- Inside cross points
- Low-set master scale
- Four way measurement
- Includes thread table

### Shipment

- Imitation leather case

**DIN  
862**



0184 501

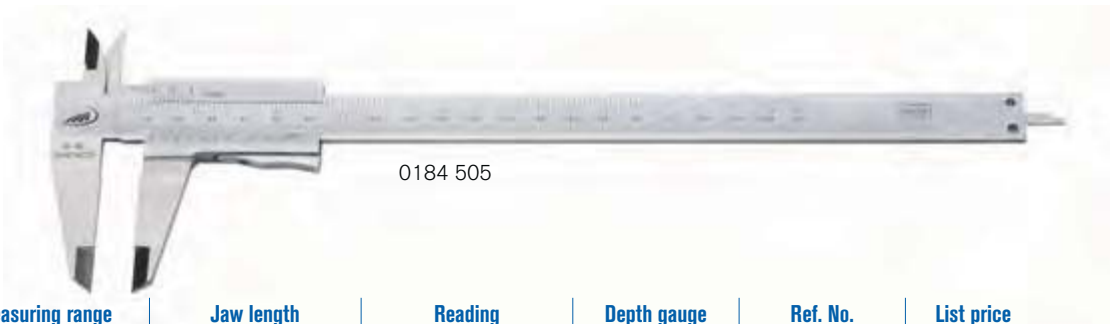

0184 505

	Measuring range	Jaw length		Reading		Depth gauge	Ref. No.	List price
		mm	inch	mm	inch			
With thumb clamp	150	6	40	1.57	0.05	1/128	0184 501	23.20
	200	8	40	1.57	0.05	1/128	0184 505	30.00
	300	12	50	1.57	0.05	1/128	0184 508	39.00

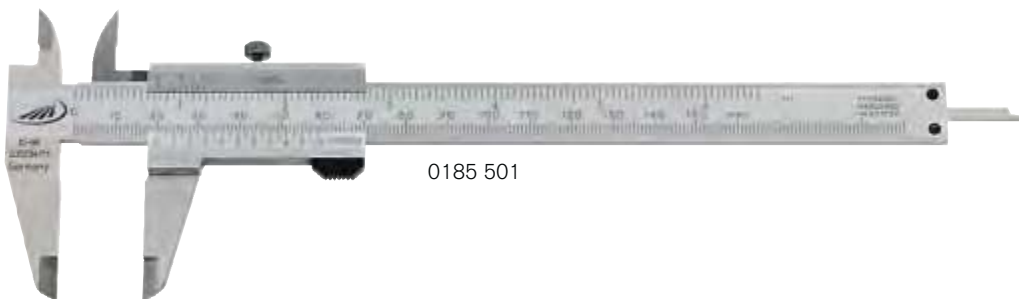

0185 501

	Measuring range	Jaw length		Reading		Depth gauge	Ref. No.	List price
		mm	inch	mm	inch			
With locking screw	100	4	30	1.18	0.05	-	0185 500	18.50
	150	6	40	1.57	0.05	1/128	0185 501	23.20
	200	8	40	1.57	0.05	1/128	0185 505	30.00
	300	12	50	1.57	0.05	1/128	0185 508	39.00

Jean Louis MENEGON - Votre représentant et Conseiller- Tél. : 06 76 08 96 83

E-mail: [jlouismenegon@aol.com](mailto:jlouismenegon@aol.com) - web: [www.menegon-metrologie.com](http://www.menegon-metrologie.com)





# HELIOS • PREISSER

## 0188 / 0189 Pocket vernier calipers



### Specification

- Stainless steel
- Reading parts have a satin chrome finish
- DIN 862
- Inside cross points
- Low-set master scale
- Four way measurement
- Includes thread table

### Shipment

- Imitation leather case

**DIN 862**

1

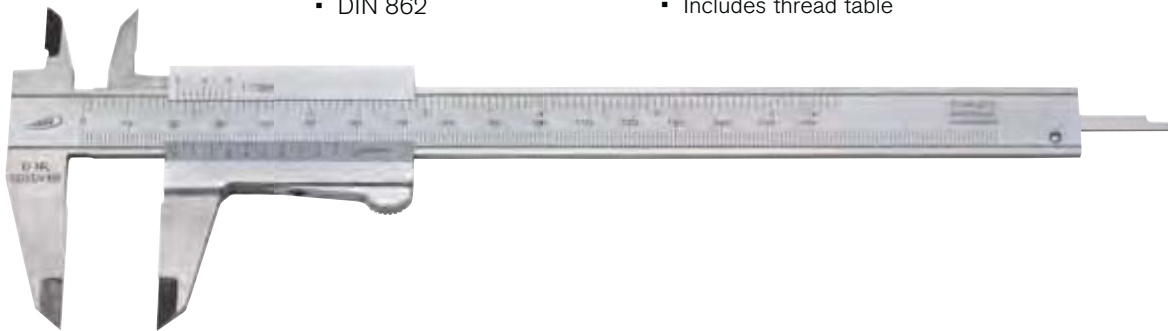

			Measuring range		Jaw length		Reading		Depth gauge	Ref. No.	List price Euro
			mm	inch	mm	inch	mm	inch			
With thumb clamp			150	6	40	1.57	0.05	1/128	rectangular	0188 501	20.10



			Measuring range		Jaw length		Reading		Depth gauge	Ref. No.	List price Euro
			mm	inch	mm	inch	mm	inch			
With locking screw			150	6	40	1.57	0.05	1/128	rectangular	0189 501	20.10

Jean Louis MENEGON - Votre représentant et Conseiller- Tél. : 06 76 08 96 83

E-mail: [jlouismenegon@aol.com](mailto:jlouismenegon@aol.com) - web: [www.menegon-metrologie.com](http://www.menegon-metrologie.com)





0194 / 0195 Pocket vernier calipers with round depth rod



Specification

- Stainless steel
- Reading parts have a satin chrome finish
- DIN 862
- Inside cross points
- Low-set master scale
- Four way measurement
- Includes thread table

Shipment

- Imitation leather case

DIN 862

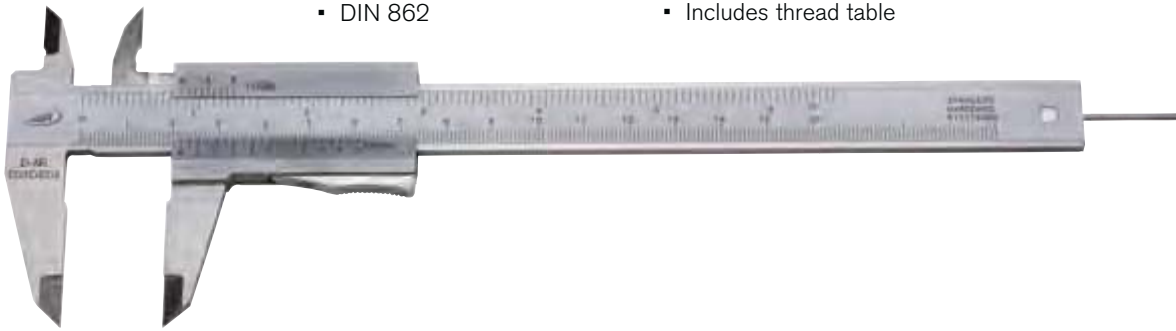

Marked *	Marked *	Measuring range		Jaw length		Reading		Depth gauge	Ref. No.	List price Euro
		mm	inch	mm	inch	mm	inch			
With thumb clamp		150	6	40	1.57	0.05	1/128	Ø 1.6 mm	0194 501	24.30



Marked *	Marked *	Measuring range		Jaw length		Reading		Depth gauge	Ref. No.	List price Euro
		mm	inch	mm	inch	mm	inch			
With locking screw		150	6	40	1.57	0.05	1/128	Ø 1.6 mm	0195 501	24.30

Jean Louis MENEGON - Votre représentant et Conseiller- Tél. : 06 76 08 96 83

E-mail: [jlouismenegon@aol.com](mailto:jlouismenegon@aol.com) - web: [www.menegon-metrologie.com](http://www.menegon-metrologie.com)



# HELIOS • PREISSER

## 0196 Pocket vernier calipers with reading 0.02 mm



### Specification

- Stainless steel
- Reading parts have a satin chrome finish
- DIN 862
- Inside cross points
- Main intervals are located deeper
- Four way measurement
- Includes thread table

### Shipment

- Imitation leather case

DIN 862

1

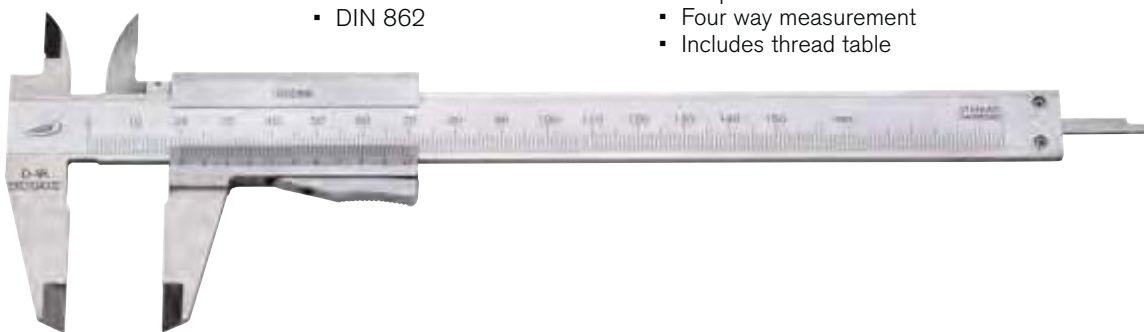

			Measuring range		Jaw length		Reading		Depth gauge	Ref. No.	List price Euro
			mm	inch	mm	inch	mm	inch			
<b>With thumb clamp</b>											
			150	6	40	1.57	0,02	-	rectangular	0196 501 05	23.20



			Measuring range		Jaw length		Reading		Depth gauge	Ref. No.	List price Euro
			mm	inch	mm	inch	mm	inch			
<b>With locking screw</b>											
			150	6	40	1.57	0,02	1/1000	rectangular	0196 501 16	23.20



**Jean Louis MENEGON** - Votre représentant et Conseiller- Tél. : 06 76 08 96 83  
E-mail: [jlouismenegon@aol.com](mailto:jlouismenegon@aol.com) - web: [www.menegon-metrologie.com](http://www.menegon-metrologie.com)

			Measuring range		Jaw length		Reading		Depth gauge	Ref. No.	List price Euro
			mm	inch	mm	inch	mm	inch			
<b>With locking screw</b>											
			200	8	40	1.57	0,02	1/1000	Ø 1.6 mm	0196 505 16	33.20



0198 / 0199 Pocket vernier calipers with parallax-free reading



**Specification**

- Parallax-free reading
- Stainless steel
- Reading parts have a satin chrome finish
- DIN 862
- Inside cross points
- Four way measurement
- Includes thread table

**Shipment**

- Imitation leather case

**DIN  
862**

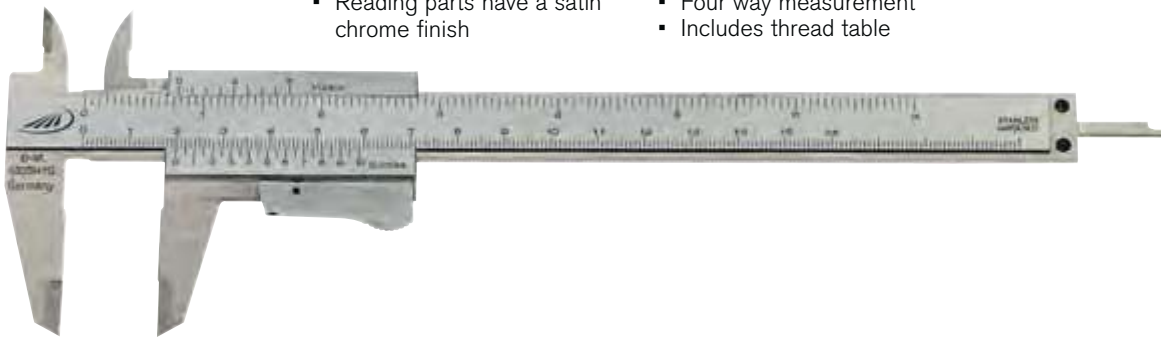

Marked *	Marked *	Measuring range		Jaw length		Reading		Depth gauge	Ref. No.	List price Euro
		mm	inch	mm	inch	mm	inch			
<b>With thumb clamp</b>										
		150	6	40	1.57	0.05	1/128	rectangular	0198 501	28.00



Marked *	Marked *	Measuring range		Jaw length		Reading		Depth gauge	Ref. No.	List price Euro
		mm	inch	mm	inch	mm	inch			
<b>With low-set locking screw</b>										
		150	6	40	1.57	0.05	1/128	rectangular	0199 501	28.00

Jean Louis MENEGON - Votre représentant et Conseiller- Tél. : 06 76 08 96 83

E-mail: [jlouismenegon@aol.com](mailto:jlouismenegon@aol.com) - web: [www.menegon-metrologie.com](http://www.menegon-metrologie.com)



# HELIOS • PREISSER

Jean Louis MENEGON - Votre représentant et Conseiller- Tél. : 06 76 08 96 83

E-mail: [jlouismenegon@aol.com](mailto:jlouismenegon@aol.com) - web: [www.menegon-metrologie.com](http://www.menegon-metrologie.com)

## 0203 Precision pocket vernier caliper PRISMA



DIN 862

1

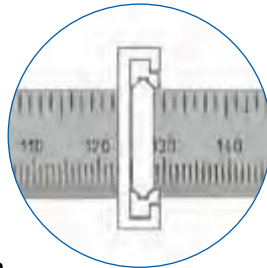

### Specification

- Parallax-free reading
- Double prisma guide with excellent sliding characteristics
- Stainless steel
- Reading parts have a satin chrome finish
- DIN 862
- Low-set locking screw
- Inside cross points
- Four way measurement
- Includes thread table

### Shipment

- Imitation leather case

			Measuring range		Jaw length		Reading		Depth gauge	Ref. No.	List price
			mm	inch	mm	inch	mm	inch			
			150	6	40	1.57	0.05	1/128	rectangular	0203 501	46.40

## 0190 Pocket vernier caliper DUO - FIX



DIN 862

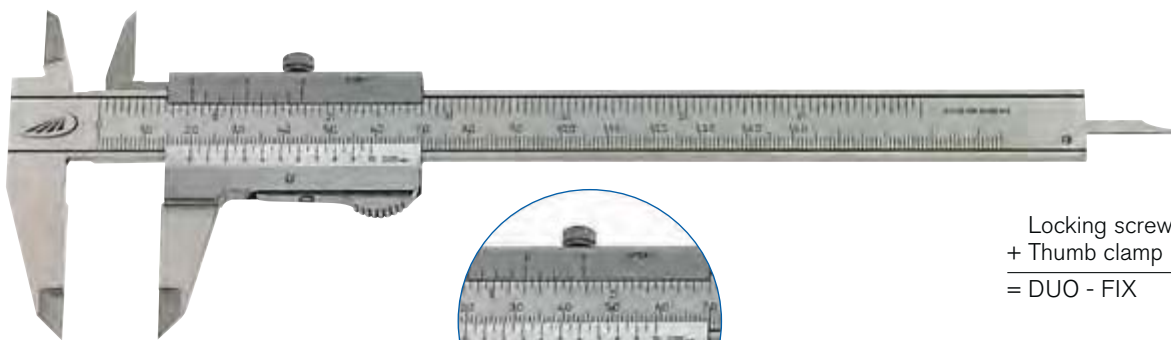

Locking screw  
+ Thumb clamp  
= DUO - FIX

### Specification

- Stainless steel
- Reading parts have a satin chrome finish
- DIN 862
- Thumb clamp and locking screw
- Inside cross points
- Low-set master scale
- Four way measurement
- Includes thread table

### Shipment

- Imitation leather case

			Measuring range		Jaw length		Reading		Depth gauge	Ref. No.	List price
			mm	inch	mm	inch	mm	inch			
			150	6	40	1.57	0.05	1/128	rectangular	0190 501	24.30



## 0182 Pocket vernier caliper for lefthanded

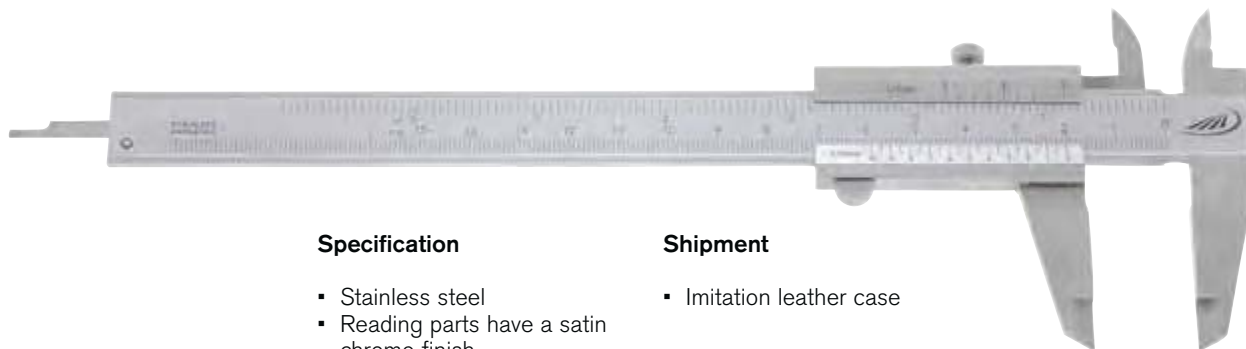

### Specification

- Stainless steel
- Reading parts have a satin chrome finish
- Locking screw
- Factory standard

### Shipment

- Imitation leather case

		Measuring range		Jaw length		Reading		Depth gauge	Ref. No	List price Euro
		mm	inch	mm	inch	mm	inch			
With locking screw		150	6	40	1.57	0.05	1/128	rectangular	0182 516	32.00

Jean Louis MENEGON - Votre représentant et Conseiller- Tél. : 06 76 08 96 83  
 E-mail: [jlouismenegon@aol.com](mailto:jlouismenegon@aol.com) - web: [www.menegon-metrologie.com](http://www.menegon-metrologie.com)





0180 Pocket caliper



Specification

- Made from hard brass
- Factory standard

Shipment

- Cardboard box

			Measuring range		Jaw length		Reading		Ref. No	List price Euro
			mm	inch	mm	inch	mm	inch		
			100	6	25	1.00	0.1	1/16	0180 320	6.50

1

0180 Pocket caliper

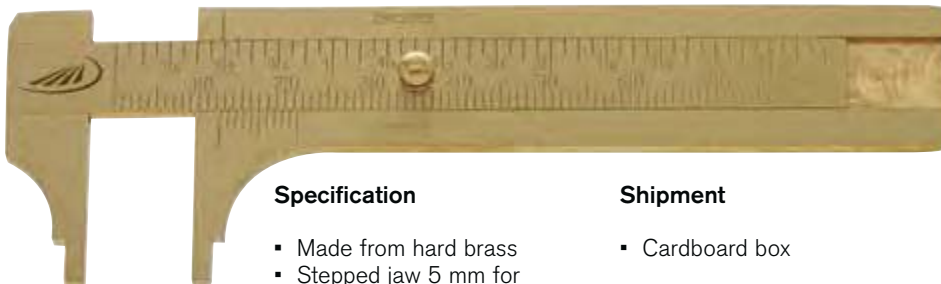

Specification

- Made from hard brass
- Stepped jaw 5 mm for internal measurement
- Factory standard

Shipment

- Cardboard box

			Measuring range		Jaw length		Reading		Ref. No	List price Euro
			mm	inch	mm	inch	mm	inch		
			100	6	25	1.00	0.1	1/16	0180 330	6.50

0180 Tyre profile depth gauge



Specification

Shipment

Jean Louis MENEGON - Votre représentant et Conseiller- Tél. : 06 76 08 96 83

E-mail: [jlouismenegon@aol.com](mailto:jlouismenegon@aol.com) - web: [www.menegon-metrologie.com](http://www.menegon-metrologie.com)

			Measuring range		Reading	Ref. No	List price Euro
			mm	inch	mm		
			30	1.18	0.1	0180 310	4.00



## 0212 Quality measuring tool set, 8 piece



### Content

- Pocket calipers in 5 different types of choice
- External micrometer with carbide measuring faces, measuring range 0-25 mm, reading 0.01 mm
- Flexible steel rule, stainless steel, measuring range 200 mm, graduation mm / mm, 13 x 0.5 mm
- Knife square, hardened, DIN 875/00, 100 x 70 mm, with non-glare knife edge
- Knife edge, hardened and ground, DIN 874/00, length 100 mm
- Scriber, carbide tipped, hexagonal handle made of one piece, with pocket clip, length 180 mm
- Radius gauge, special steel, 17 sheets, concave and convex, with locking nut, measuring range 1.0 – 7.0 mm
- Screw pitch gauge, combined metric ISO- and Whitworth thread, 48 blades, increments 0.4 – 7.0 / 4 – 62

### Shipment

- Wooden case

## Choose between different calipers!

### Set with DUO - FIX

#### Pocket vernier caliper

Measuring range 150 mm,  
Reading 1/20mm und 1/128"

### Set with DIGI-MET®

#### Pocket vernier caliper

Measuring range 150 mm,  
Reading 0.01 mm / .0005 inch

### Set with DIGI-MET®

#### Pocket vernier caliper IP 67

Measuring range 150 mm,  
Reading 0.01 mm / .0005 inch

Depth gauge	Ref. No.	Set price Euro
rectangular	0212 520	123.00

Depth gauge	Ref. No.	Set price Euro
Ø 1.5 mm	0212 522	180.00
rectangular	0212 524	180.00

Depth gauge	Ref. No.	Set price Euro
Ø 1.5 mm	0212 526	205.00
rectangular	0212 528	205.00



Jean Louis MENEGON - Votre représentant et Conseiller- Tél. : 06 76 08 96 83

E-mail: [jlouismenegon@aol.com](mailto:jlouismenegon@aol.com) - web: [www.menegon-metrologie.com](http://www.menegon-metrologie.com)



# HELIOS • PREISSER

## 0216 Dial calipers with long inside cross points



1

### Specification

- Stainless steel
- Satin chrome scale
- Factory standard
- Locking screw

### Shipment

- Inside cross points
- One pointer revolution = 10 mm
- Adjustable dial face
- Fitted case

✂	🔒	Measuring range		Jaw length		Length of cross points	Reading	Depth gauge	Ref. No.	List price
		mm	inch	mm	inch					
		150	6	40	1.57	40	0.05	rectangular	0216 521	339.00

## 0217 / 0218 Dial calipers



DIN 862

### Specification

- Stainless steel
- Satin chrome scale
- DIN 862
- Locking screw
- Inside cross points

### Shipment

- One pointer revolution with 0217 = 2 mm
- One pointer revolution with 0218 = 1 mm
- Four way measurement
- Fitted case

✂	🔒	Measuring range		Jaw length		Reading	Depth gauge	Ref. No.	List price
		mm	inch	mm	inch				
▪		150	6	40	1.57	0.02	rectangular	0217 501	63.00
		200	8	40	1.57	0.02	rectangular	0217 502	126.00
▪		150	6	40	1.57	0.01	rectangular	0218 501	84.00

Jean Louis MENEGON - Votre représentant et Conseiller- Tél. : 06 76 08 96 83  
 E-mail: [jlouismenegon@aol.com](mailto:jlouismenegon@aol.com) - web: [www.menegon-metrologie.com](http://www.menegon-metrologie.com)





## DIGI-MET® QuickStart Electronic



### QuickStart-Electronic with the QuickLock-Function for only one zero setting



All digital calipers with the **QuickStart-Electronic** also have the **QuickLock** Function. Only set the zero position once, zero position remains stored for all further measurements. When the **QuickLock** Function is activated a lock symbol appears in the display, this ensures that the zero position is protected against any operating error caused by accidental usage of the operating keys (keys are locked). The caliper is immediately ready for measurement; once the caliper is switched ON or the slide is moved, the display is automatically activated.

The need to reset to zero as with a conventional caliper once it is switched on is obsolete.

#### Conventional

- ① Switch ON
- ② Close the measuring jaws
- ③ Set to zero
- ④ Result of measurement

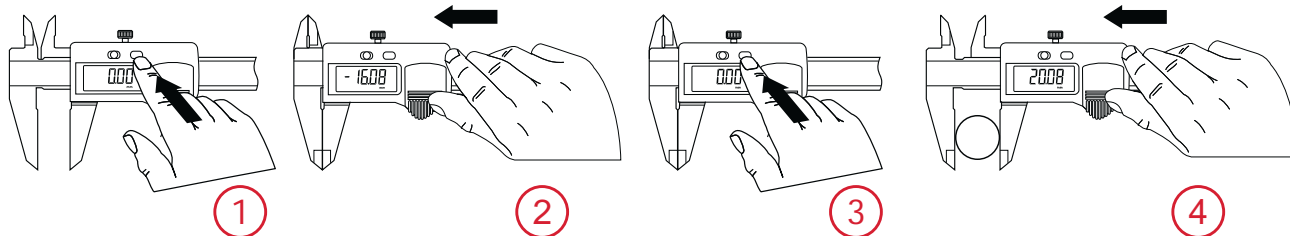

#### QuickStart Electronic

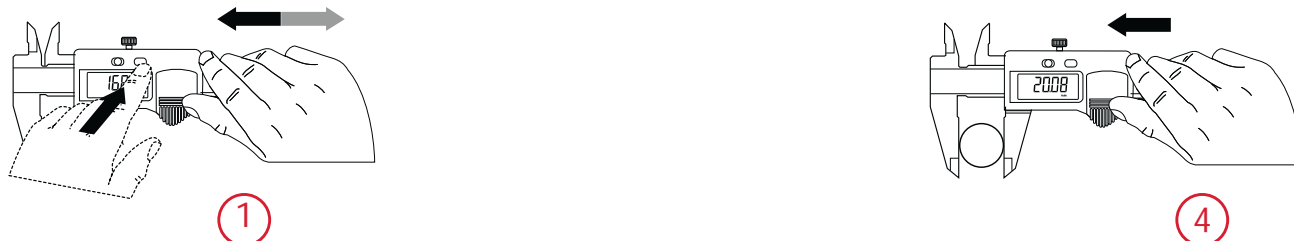

Press the ON key or move the slide

## DIGI-MET® QuickLock Function



- 1. Set to zero
- 2. Activate the **QuickLock** Function

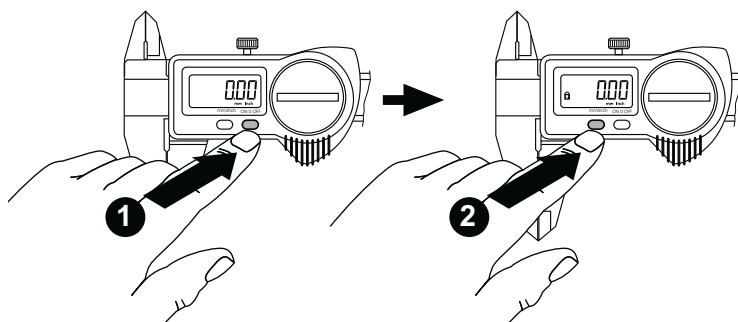

#### Advantages of the QuickLock Function

- The caliper is immediately ready for measurement
- Lock symbol appears in the display. This ensures that the zero position is protected against any operating error caused by accidental usage of the operating keys (keys are locked)

Jean Louis MENEGON - Votre représentant et Conseiller- Tél. : 06 76 08 96 83

E-mail: [jlouismenegon@aol.com](mailto:jlouismenegon@aol.com) - web: [www.menegon-metrologie.com](http://www.menegon-metrologie.com)



# HELIOS • PREISSER

## 1320 DIGI-MET® Pocket calipers

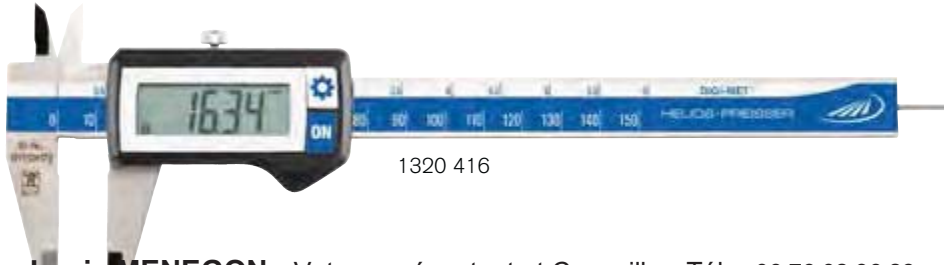

1320 416



**Jean Louis MENEGON** - Votre représentant et Conseiller- Tél. : **06 76 08 96 83**  
 E-mail: [jlouismenegon@aol.com](mailto:jlouismenegon@aol.com) - web: [www.menegon-metrologie.com](http://www.menegon-metrologie.com)



1320 517



### Specification

- Inductive measuring system, resistant to damp and sweat
- Stainless steel
- LCD display 11 mm without data output, 7.5 mm with data output
- DIN 862
- Locking screw
- Inside cross points
- Four way measurement with measuring ranges 150 and 200 mm
- Three way measurement with measuring range 300 mm

### Electronic functions

- ON/OFF switch
- **QuickStart** Electronic
- **QuickLock** Function
- Zero setting at any position
- mm/inch conversion
- Variable data output RS 232 + Digimatic + USB

### Shipment

- Plastic case, 1320 518 = Wooden case

			Measuring range		Jaw length		Reading		Depth gauge	Ref. No.	List price Euro
			mm	inch	mm	inch	mm	inch			
<b>Without data output</b>											
▪			150	6	40	1.57	0.01	.0005	Ø 1.5 mm	1320 416	105.00
▪			150	6	40	1.57	0.01	.0005	rectangular	1320 417	105.00
<b>With DATA VARIABLE</b>											
▪			150	6	40	1.57	0.01	.0005	Ø 1.5 mm	1320 516	137.00
▪			150	6	40	1.57	0.01	.0005	rectangular	1320 517	137.00
			200	8	50	1.97	0.01	.0005	rectangular	1320 519	172.00
			300	12	65	2.34	0.01	.0005	without	1320 522	221.00
<b>With DATA VARIABLE, with long inside cross points</b>											
			150	6	40	1.57	0.01	.0005	Ø 1.5 mm	1320 518	370.00

### Accessories

	Ref. No.	List price Euro
Battery, 3V-Lithium, CR 2032	0220 704	3.60
Cable for USB, incl. software	1998 720	66.00
Cable for RS 232	1997 501	46.20
Cable for Digimatic	1998 501	59.00



## 1326 DIGI-MET® Pocket calipers IP67

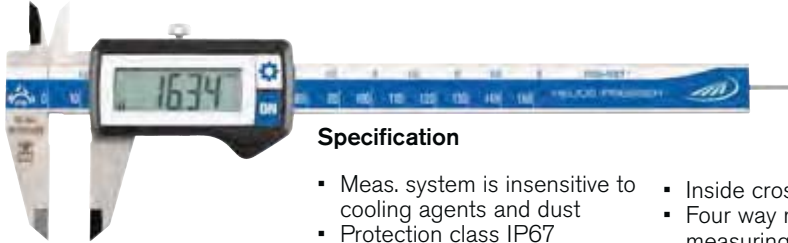

### Specification

- Meas. system is insensitive to cooling agents and dust
- Protection class IP67
- Stainless steel
- LCD display 11 mm
- DIN 862
- Housing and operating keys have an excellent chemical resistance
- Locking screw
- Inside cross points
- Four way measurement with measuring ranges 150 and 200 mm
- Three way measurement with measuring range 300 mm

### Electronic functions

- ON/OFF switch
- QuickStart Electronic
- QuickLock Function
- Zero setting at any position
- mm/inch conversion
- PRESET Function (setting a numerical value)

### Shipment

- Plastic case

Marked *	Marked *	Measuring range		Jaw length		Reading		Depth gauge	Ref. No.	List price Euro
		mm	inch	mm	inch	mm	inch			
▪		150	6	40	1.57	0.01	.0005	Ø 1.5 mm	1326 416	152.00
▪		150	6	40	1.57	0.01	.0005	rectangular	1326 417	152.00
▪		200	8	50	2.00	0.01	.0005	rectangular	1326 418	211.00
▪		300	12	65	2.50	0.01	.0005	without	1326 422	267.00
<b>With carbide tipped measuring jaws</b>										
		150	6	40	1.57	0.01	.0005	Ø 1.5 mm	1326 914	317.00

### Accessories

Battery, 3V-Lithium, CR 2032

Ref. No.	List price Euro
0220 704	3.60

## 1326 DIGI-MET® Pocket calipers IP67 with data output



### Specification

- Protection class IP67
- Measuring system is insensitive to fluids and cooling agents
- Stainless steel
- LCD display 7.5 mm
- DIN 862
- Locking screw
- Inside cross points
- Four way measurement

### Electronic functions

- ON/OFF switch
- QuickStart Electronic
- QuickLock Function
- Zero setting at any position
- mm/inch conversion
- Variable data output RS 232 + Digimatic + USB

### Shipment

- Wooden case

Marked *	Marked *	Measuring range		Jaw length		Reading		Depth gauge	Ref. No.	List price Euro
		mm	inch	mm	inch	mm	inch			
▪		150	6	40	1.57	0.01	.0005	Ø 1,5 mm	1326 516	152.00
▪		150	6	40	1.57	0.01	.0005	rectangular	1326 517	152.00
▪		200	8	50	2.00	0.01	.0005	rectangular	1326 518	222.00
<b>Accessories</b>										
Battery, 3V-Lithium, CR 2032									0220 704	3.60
Cable for USB incl. software									1998 720	66.00

Jean Louis MENEGON - Votre représentant et Conseiller- Tél. : 06 76 08 96 83

E-mail: [jlouismenegon@aol.com](mailto:jlouismenegon@aol.com) - web: [www.menegon-metrologie.com](http://www.menegon-metrologie.com)

1997 501	46.20
1998 501	59.00



# HELIOS • PREISSER

## 1322 DIGI-MET® Pocket caliper PRISMA



1

### Specification

- Double prisma guide with excellent sliding characteristics
- Protection class IP67
- Stainless steel
- DIN 862
- LCD display 7.5 mm
- Locking screw
- Inside cross points
- Four way measurement

### Electronic functions

- ON/OFF switch
- QuickStart Electronic
- QuickLock Function
- Zero setting at any position
- mm/inch conversion
- Variable data output RS 232 + Digimatic + USB

### Shipment

- Wooden case

	Measuring range	Jaw length		Reading		Depth gauge	Ref. No.	List price Euro	
		mm	inch	mm	inch				mm
	150	6	40	1.57	0.01	.0005	Ø 1.5 mm	1322 516	195.00

### Accessories

	Ref. No.	List price Euro
Battery, 3V-Lithium, CR 2032	0220 704	3.60
Cable for USB incl. software	1998 720	66.00
Cable for RS 232	1997 501	46.20
Cable for Digimatic	1998 501	59.00

## Depth attachment base



### Specification

- Stainless steel
- Suitable for all pocket calipers
- Bridge length: 75 mm
- Dimensions: 75 x 6.5 mm

### Shipment

- Cardboard box

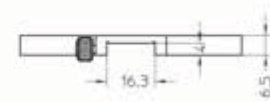
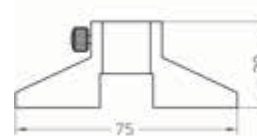

Jean Louis MENEGON - Votre représentant et Conseiller- Tél. : 06 76 08 96 83  
E-mail: [jlouismenegon@aol.com](mailto:jlouismenegon@aol.com) - web: [www.menegon-metrologie.com](http://www.menegon-metrologie.com)

Ref. No.	List price Euro
0220 705	20.70



## Connecting cables for DIGI-MET® instruments



1998 720



1997 501



1998 501



0996 701



0996 705

Note: detailed information regarding data cables, keyboard interfaces and wireless solutions see pages 270 and following

	Ref. No.	List price Euro
Cable for USB incl. software	1998 720	66.00
Cable for RS 232	1997 501	46.20
Cable for Digimatic	1998 501	59.00
Cable for Opto to RS 232	0996 701	71.00
Cable for Opto to USB	0996 705	136.00

## 0145 Measuring tool set »Extensions«

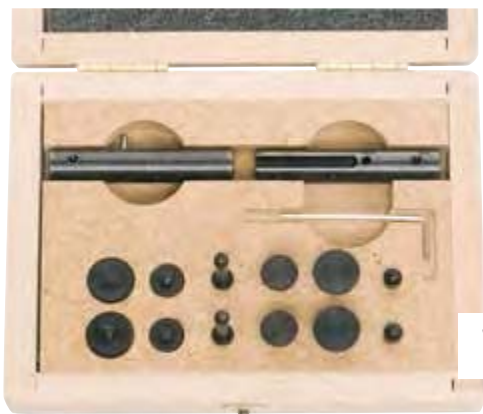

### Set consists of:

- Pair of measuring inserts with disc, disc dia. 6 / 10 / 12,5 mm
- Pair of measuring inserts with 60° cone, dia. 9 / 12 mm
- Pair of measuring inserts with cylindrical surfaces 1.5 mm
- Insert holder, right / left with thread M 2,5\*
- Allen wrench SW 1,2 mm

### Shipment

- Wooden case

Jean Louis MENEGON - Votre représentant et Conseiller- Tél. : 06 76 08 96 83

E-mail: [jlouismenegon@aol.com](mailto:jlouismenegon@aol.com) - web: [www.menegon-metrologie.com](http://www.menegon-metrologie.com)

	Ref. No.	List price Euro
Measuring tool set »Extensions«	0145 110	158.00



Measure distances between bore holes



Measure grooves



Measure distances



Measure distances between bore holes



Measure grooves

\* further inserts see Ref No. 0710 pages 132 and following



# HELIOS • PREISSER

## 1326 Universal pocket caliper "Pocket Talent"

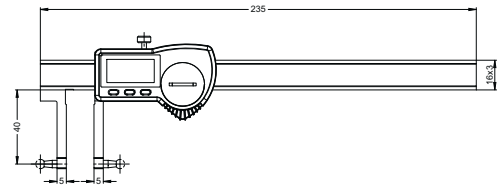

### Specification

- Stainless steel
- Protection class IP67
- Factory standard
- LCD display 7.5 mm
- Locking screw
- For internal and external measurements
- Individually adaptable on problematic tasks through measuring inserts with thread M 2.5
- Shipment in wooden case, incl. setting standard

### Electronic functions

- ON/OFF switch
- QuickStart Electronic
- QuickLock Function
- Zero setting at any position
- mm/inch conversion
- Variable data output RS 232 + Digimatic + USB
- PRESET Function (setting a

### Shipment

- Wooden case
- \* Includes pairs of measuring inserts
- Balls Ø 5.0 mm
- Planar surface Ø 4.8 mm

Jean Louis MENEGON - Votre représentant et Conseiller- Tél. : 06 76 08 96 83 )

E-mail: [jlouismenegon@aol.com](mailto:jlouismenegon@aol.com) - web: [www.menegon-metrologie.com](http://www.menegon-metrologie.com)

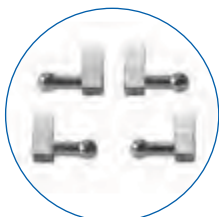

0710177\*

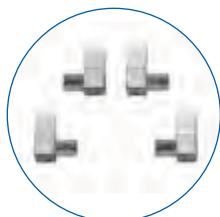

0710161\*



0710166

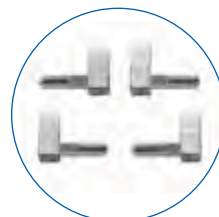

0710167



0710163

### Application

\*Standard shipment

The all-round talent which in conjunction with all common types of measuring inserts for indicators with a standard M 2.5 thread can be used for internal and external measurements. Therefore, the small universal caliper, "Pocket-Talent" offers you conduct numerous measurement applications.

Icon	Measuring range		Jaw length		Reading		Ref. No.	List price Euro
	mm	inch	mm	inch	mm	inch		
	150	6	40	1.57	0.01	.0005	1326 932	339.00

### Accessories

	Ref. No.	List price Euro
Battery, 3V-Lithium, CR 2032	0220 704	3.60
Cable for USB incl. software	1998 720	66.00
Cable for RS 232	1997 501	46.20
Cable for Digimatic	1998 501	59.00



### Universal depth gauge with interchangeable inserts



Measuring ranges  
300 and 500 mm  
See no. 1379 page 76



1279 780\*



1279 781



1279 782

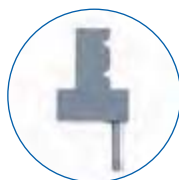

1279 783



1279 784

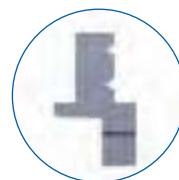

1279 785

### Universal caliper with exchangeable inserts



Measuring ranges  
300 and 500 mm  
See no. 1348 page 56

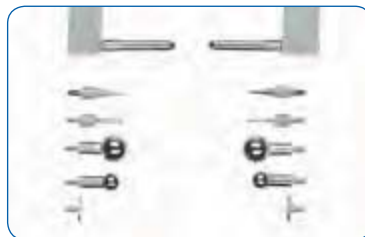
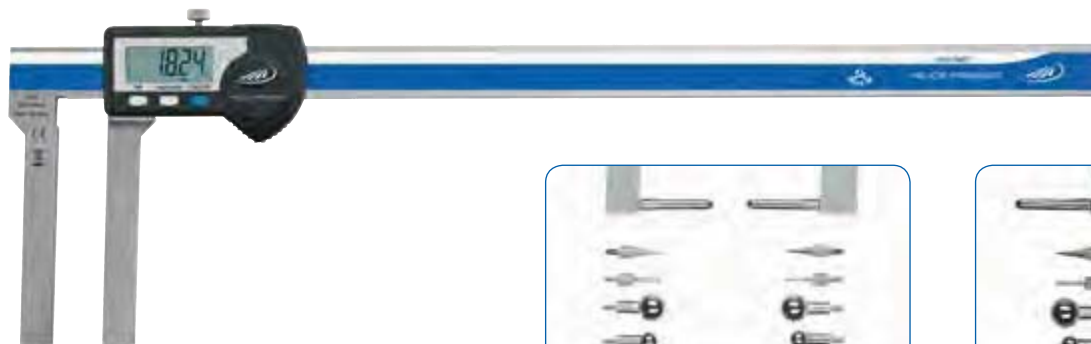

▪ for external measurements



▪ for internal measurements

Jean Louis MENEGON - Votre représentant et Conseiller- Tél. : 06 76 08 96 83  
E-mail: [jlouismenegon@aol.com](mailto:jlouismenegon@aol.com) - web: [www.menegon-metrologie.com](http://www.menegon-metrologie.com)





## 1326 DIGI-MET® Pocket calipers for specific measuring tasks

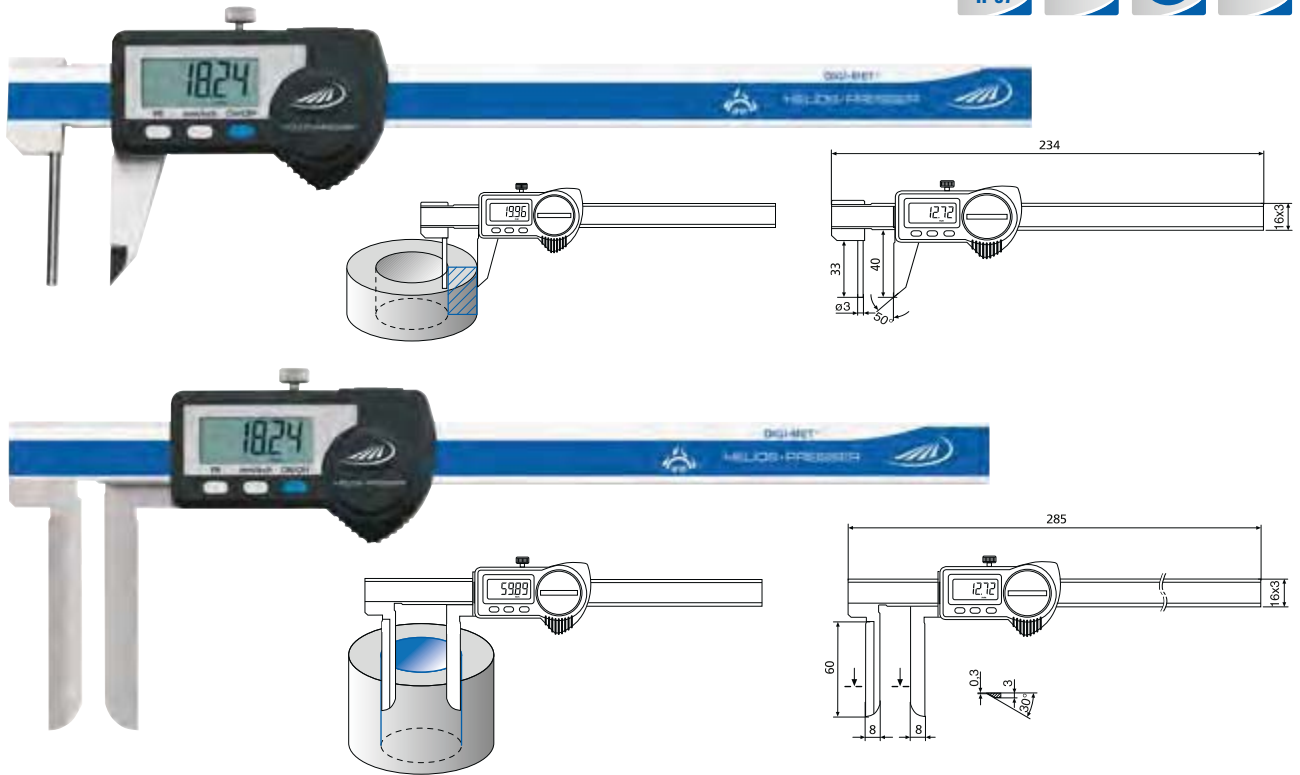

### Specification

- Protection class IP67
- Stainless steel
- LCD display 7.5 mm
- Factory standard
- Measuring system is insensitive to cooling agents and dust
- Housing and operating keys have an excellent chemical resistance
- Locking screw

### Electronic functions

- ON/OFF switch
- **QuickStart** Electronic
- **QuickLock** Function
- Zero setting at any position
- mm/inch conversion
- Variable data output  
RS 232 + Digimatic + USB
- PRESET Function (setting a numerical value)

### Shipment

- Wooden case

Jean Louis MENEGON - Votre représentant et Conseiller- Tél. : 06 76 08 96 83

E-mail: [jlouismenegon@aol.com](mailto:jlouismenegon@aol.com) - web: [www.menegon-metrologie.com](http://www.menegon-metrologie.com)

		Measuring range		Jaw length		Reading		Ref. No.	List price Euro
		mm	inch	mm	inch	mm	inch		
<b>Wall thickness pocket caliper</b>									
		0 - 150	0 - 6	40	1.57	0.01	.0005	1326 918	465.00
<b>With long narrow measuring jaws for internal measurements</b>									
		10 - 200	4 - 8	60	2.36	0.01	.0005	1326 930	603.00

### Accessories

	Ref. No.	List price Euro
Battery, 3V-Lithium, CR 2032	0220 704	3.60
Cable for USB incl. software	1998 720	66.00
Cable for RS 232	1997 501	46.20
Cable for Digimatic	1998 501	59.00





1326 DIGI-MET® Pocket calipers for specific measuring tasks

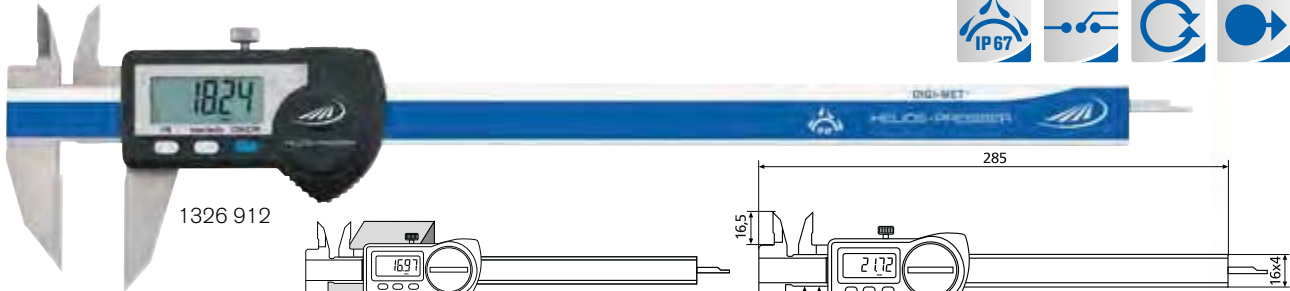

1326 912

Jean Louis MENEGON - Votre représentant et Conseiller- Tél. : 06 76 08 96 83  
E-mail: [jlouismenegon@aol.com](mailto:jlouismenegon@aol.com) - web: [www.menegon-metrologie.com](http://www.menegon-metrologie.com)

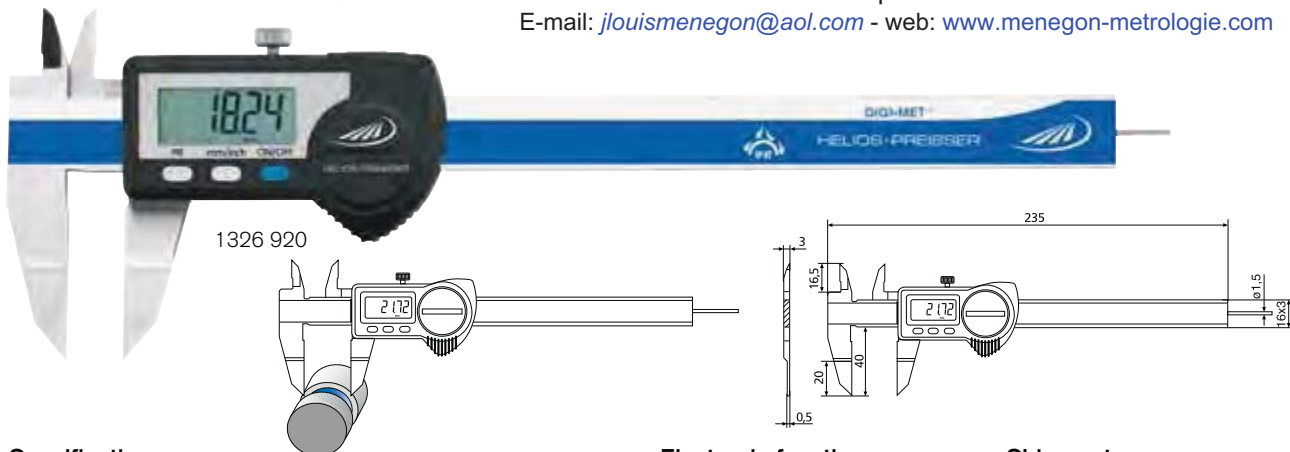

1326 920

**Specification**

- Protection class IP67
- Stainless steel
- LCD display 7.5 mm
- Factory standard
- Measuring system is insensitive to cooling agents and dust
- Housing and operating keys have an excellent chemical resistance
- Locking screw
- Inside cross points

**Electronic functions**

- ON/OFF switch
- QuickStart Electronic
- QuickLock Function
- Zero setting at any position
- mm/inch conversion
- Variable data output RS 232 + Digimatic + USB
- PRESET Function (setting a numerical value)

**Shipment**

- Wooden case

⌘	⚡	Measuring range		Jaw length		Reading		Ref. No.	List price Euro
		mm	inch	mm	inch	mm	inch		
<b>Scribing / marking pocket caliper with carbide tipped measuring faces</b>									
		200	8	33 / 40	1.29 / 1.57	0.01	.0005	1326 912	295.00
<b>With flat measuring faces for external grooves</b>									
		150	6	40	1.57	0.01	.0005	1326 920	503.00

**Accessories**

	Ref. No.	List price Euro
Battery, 3V-Lithium, CR 2032	0220 704	3.60
Cable for USB incl. software	1998 720	66.00
Cable for RS 232	1997 501	46.20
Cable for Digimatic	1998 501	59.00



# HELIOS • PREISSER

## 1326 DIGI-MET® Pocket calipers for specific measuring tasks



1

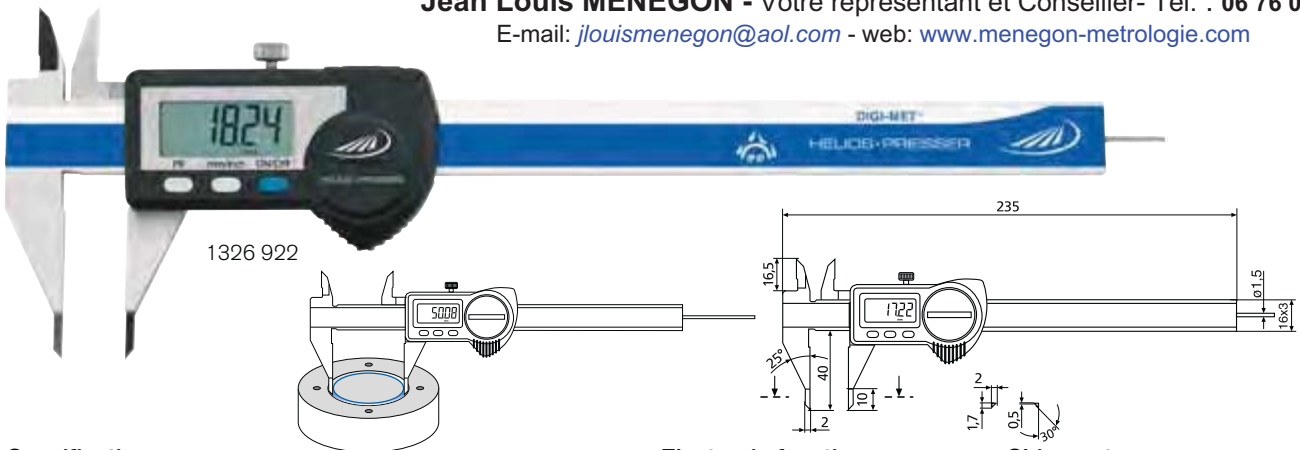
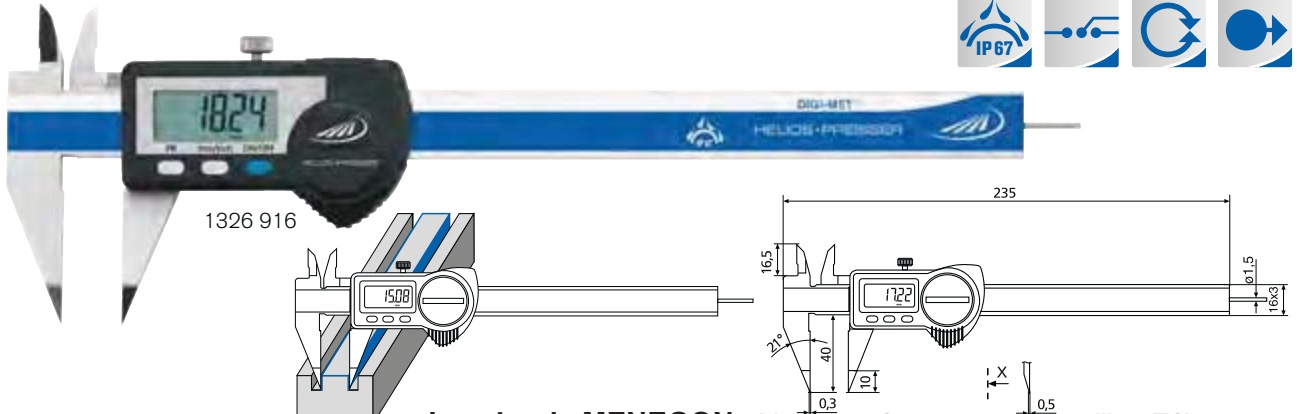

Jean Louis MENEGON - Votre représentant et Conseiller- Tél. : 06 76 08 96 83  
E-mail: [jlouismenegon@aol.com](mailto:jlouismenegon@aol.com) - web: [www.menegon-metrologie.com](http://www.menegon-metrologie.com)

### Specification

- Protection class IP67
- Stainless steel
- LCD display 7.5 mm
- Factory standard
- Measuring system is insensitive to cooling agents and dust
- Housing and operating keys have an excellent chemical resistance
- Locking screw
- Inside cross points

### Electronic functions

- ON/OFF switch
- QuickStart Electronic
- QuickLock Function
- Zero setting at any position
- mm/inch conversion
- Variable data output RS 232 + Digimatic + USB
- PRESET Function (setting a numerical value)

### Shipment

- Wooden case

			Measuring range		Jaw length		Reading		Ref. No.	List price Euro
			mm	inch	mm	inch	mm	inch		
<b>With pointed measuring jaws</b>										
			150	6	40	1.57	0.01	.0005	1326 916	366.00
<b>With precise measuring points</b>										
			150	6	40	1.57	0.01	.0005	1326 922	413.00

### Accessories

	Ref. No.	List price Euro
Battery, 3V-Lithium, CR 2032	0220 704	3.60
Cable for USB incl. software	1998 720	66.00
Cable for RS 232	1997 501	46.20
Cable for Digimatic	1998 501	59.00



1326 DIGI-MET® Pocket calipers for specific measuring tasks

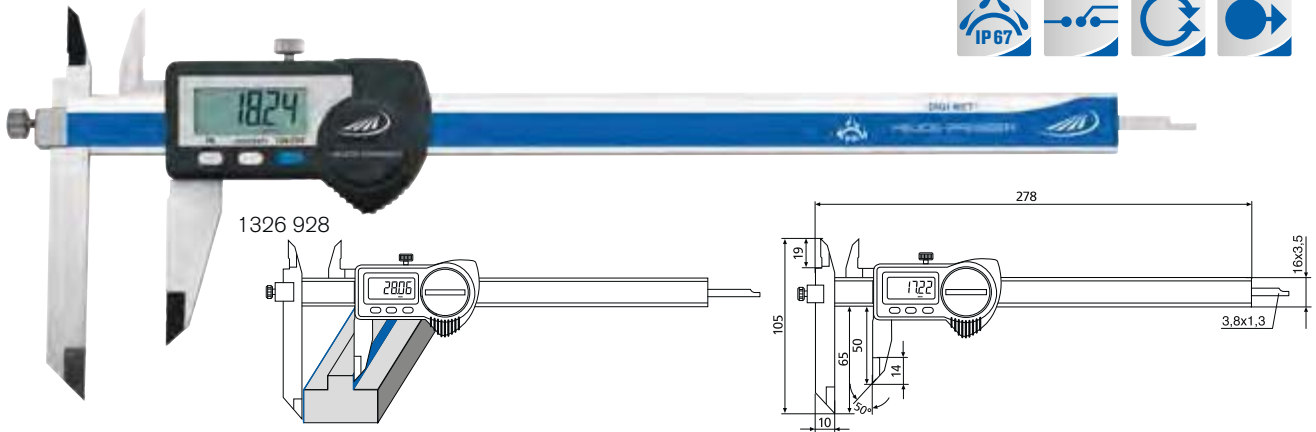

Jean Louis MENEGON - Votre représentant et Conseiller- Tél. : 06 76 08 96 83  
E-mail: [jlouismenegon@aol.com](mailto:jlouismenegon@aol.com) - web: [www.menegon-metrologie.com](http://www.menegon-metrologie.com)

**Specification**

- Protection class IP67
- Stainless steel
- LCD display 7,5 mm
- Factory standard
- Measuring system is insensitive to cooling agents and dust
- Housing and operating keys have an excellent chemical resistance
- Locking screw

**Electronic functions**

- ON/OFF switch
- QuickStart Electronic
- QuickLock Function
- Zero setting at any position
- mm/inch conversion
- Variable data output RS 232 + Digimatic + USB
- PRESET Function (setting a numerical value)

**Shipment**

- Wooden case

⚡	🔧	Measuring range		Jaw length		Reading		Ref. No.	List price Euro
		mm	inch	mm	inch	mm	inch		
<b>Offset type pocket caliper with adjustable measuring jaws + inside cross points</b>									
		0 - 200	0 - 8	65 / 50	2.55 / 1.96	0.01	.0005	1326 928	440.00
<b>Offset centerline pocket caliper with adjustable measuring jaws ideal for bore hole distance measurement</b>									
		10 - 210	.4 - 8.3	75 / 30	2.95 / 1.18	0.01	.0005	1326 924	409.00

**Accessories**

	Ref. No.	List price Euro
Battery, 3V-Lithium, CR 2032	0220 704	3.60
Cable for USB incl. software	1998 720	66.00
Cable for RS 232	1997 501	46.20
Cable for Digimatic	1998 501	59.00



## 1326 DIGI-MET® Pocket calipers for specific measuring tasks



1326 904



Jean Louis MENEGON - Votre représentant et Conseiller- Tél. : 06 76 08 96 83  
E-mail: [jlouismenegon@aol.com](mailto:jlouismenegon@aol.com) - web: [www.menegon-metrologie.com](http://www.menegon-metrologie.com)



1326 908

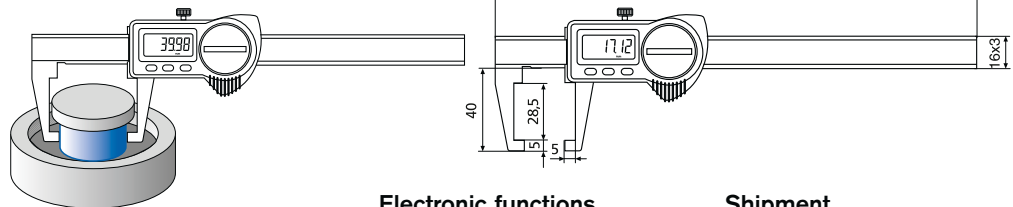

### Specification

- Protection class IP67
- Stainless steel
- LCD display 7.5 mm
- Factory standard
- Measuring system is insensitive to cooling agents and dust
- Housing and operating keys have an excellent chemical resistance
- Locking screw

### Electronic functions

- ON/OFF switch
- QuickStart Electronic
- QuickLock Function
- Zero setting at any position
- mm/inch conversion
- Variable data output RS 232 + Digimatic + USB
- PRESET Function (setting a numerical value)

### Shipment

- Wooden case

Symbol	Symbol	Measuring range		Jaw length		Reading		Ref. No.	List price Euro
		mm	inch	mm	inch	mm	inch		
		150	6	40	1.57	0.01	.0005	1326 904	529.00
		150	6	40	1.57	0.01	.0005	1326 908	451.00

### Accessories

	Ref. No.	List price Euro
Battery, 3V-Lithium, CR 2032	0220 704	3.60
Cable for USB incl. software	1998 720	66.00
Cable for RS 232	1997 501	46.20
Cable for Digimatic	1998 501	59.00



1326 DIGI-MET® Pocket calipers for specific measuring tasks

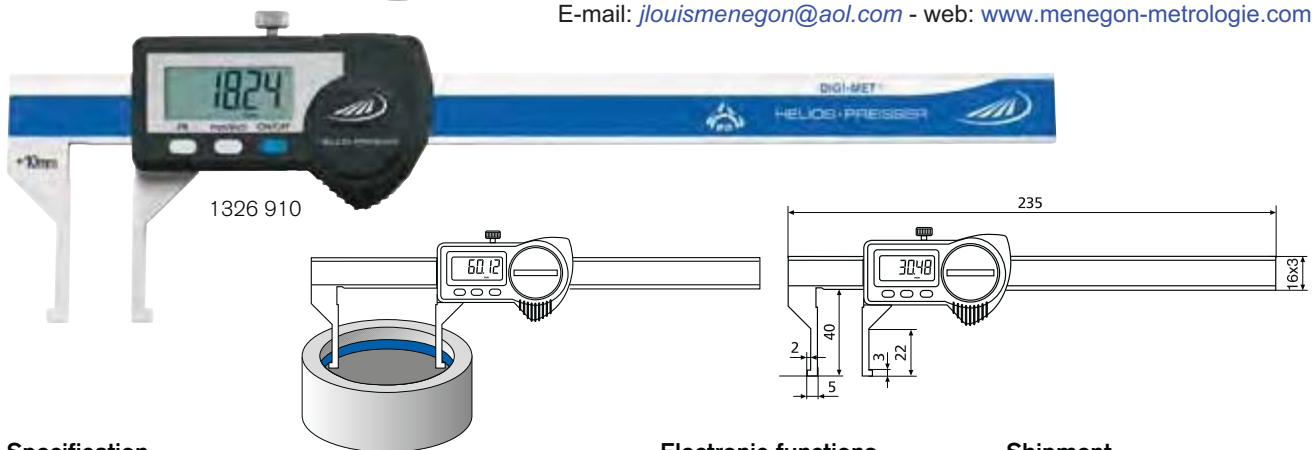
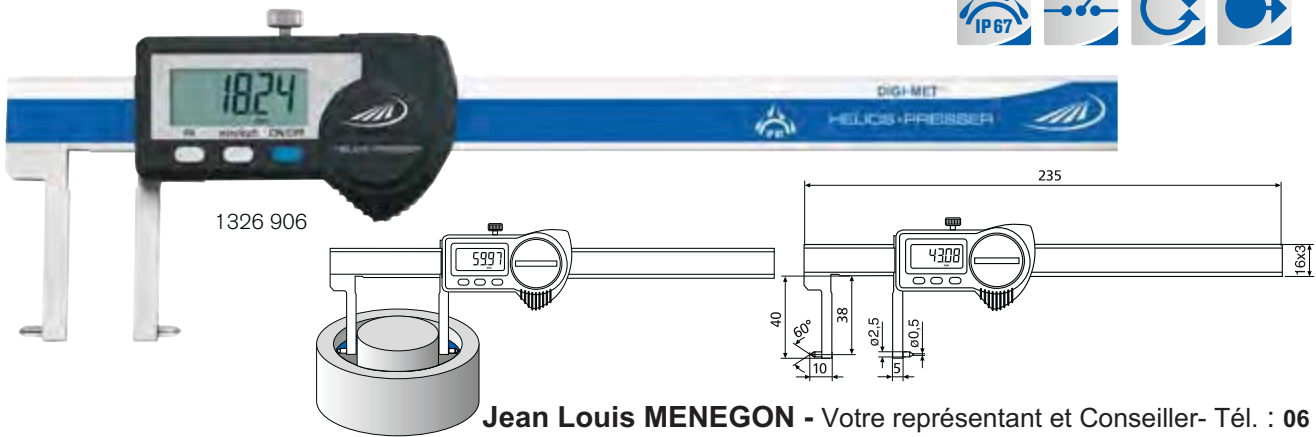

Jean Louis MENEGON - Votre représentant et Conseiller- Tél. : 06 76 08 96 83  
E-mail: [jlouismenegon@aol.com](mailto:jlouismenegon@aol.com) - web: [www.menegon-metrologie.com](http://www.menegon-metrologie.com)

**Specification**

- Protection class IP67
- Stainless steel
- LCD display 7.5 mm
- Factory standard
- Measuring system is insensitive to cooling agents and dust
- Housing and operating keys have an excellent chemical resistance
- Locking screw

**Electronic functions**

- ON/OFF switch
- **QuickStart** Electronic
- **QuickLock** Function
- Zero setting at any position
- mm/inch conversion
- Variable data output RS 232 + Digimatic + USB
- PRESET Function (setting a numerical value)

**Shipment**

- Wooden case

⊗	⚡	Measuring range		Jaw length		Reading		Ref. No.	List price Euro
		mm	inch	mm	inch	mm	inch		
<b>Outwardly angled anvils</b>									
		20.5 - 170	.8 - 6.7	40	1.57	0.01	.0005	1326 906	525.00
<b>Outwardly angled measuring jaws</b>									
		10.5 - 160	.4 - 6.3	40	1.57	0.01	.0005	1326 910	519.00

**Accessories**

	Ref. No.	List price Euro
Battery, 3V-Lithium, CR 2032	0220 704	3.60
Cable for USB incl. software	1998 720	66.00
Cable for RS 232	1997 501	46.20
Cable for Digimatic	1998 501	59.00



# HELIOS • PREISSER

## 0230 / 0231 Workshop calipers with parallax-free reading



### Specification

- Parallax-free reading
- Stainless steel
- Reading parts have a satin chrome finish
- DIN 862
- Locking screw
- Knife points
- Stepped jaws for inside measurement: 10 mm, for measuring range 500 mm: 20 mm
- Direct reading of internal and external measurements
- High-precision laser graduation on the vernier and scale

### Shipment

- Cardboard box

DIN 862

1

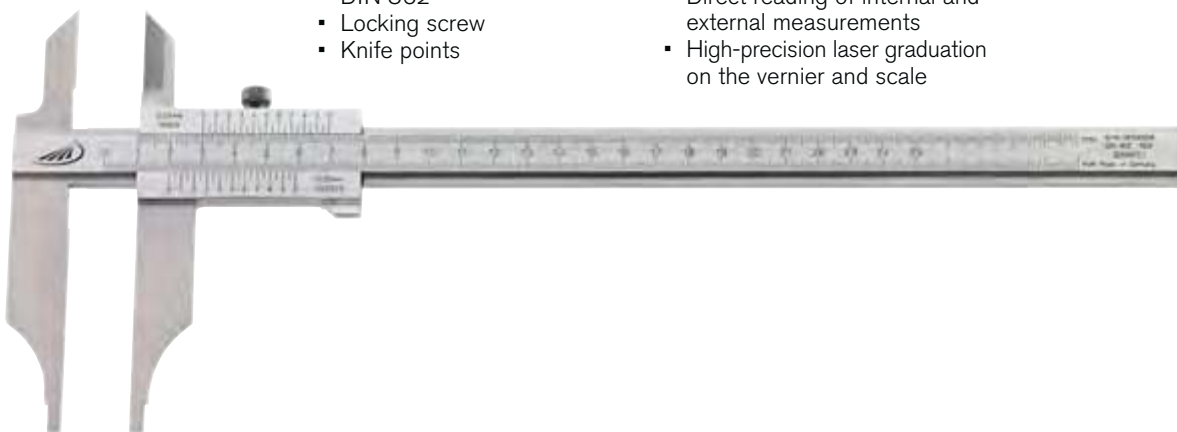

		Measuring range		Jaw length		Reading		Ref. No.	List price Euro
		mm	inch	mm	inch	mm	mm		
<b>Without fine adjustment</b>									
▪		200	8	80	3.0	0.05	0.05	0230 501	135.00
▪		250	10	80	3.0	0.05	0.05	0230 502	150.00
▪		300	12	90	3.5	0.05	0.05	0230 503	165.00
		500	20	150	6.0	0.05	0.05	0230 508	471.00



		Measuring range		Jaw length		Reading		Ref. No.	List price Euro
		mm	inch	mm	inch	mm	mm		
<b>With fine adjustment</b>									
▪		200	8	80	3.0	0.05	0.05	0231 501	160.00
▪		250	10	80	3.0	0.05	0.05	0231 502	175.00
▪		300	12	90	3.5	0.05	0.05	0231 503	190.00
		500	20	150	6.0	0.05	0.05	0231 508	515.00

Jean Louis MENEGON - Votre représentant et Conseiller- Tél. : 06 76 08 96 83

E-mail: [jlouismenegon@aol.com](mailto:jlouismenegon@aol.com) - web: [www.menegon-metrologie.com](http://www.menegon-metrologie.com)



## 0234 Workshop calipers



**DIN  
862**

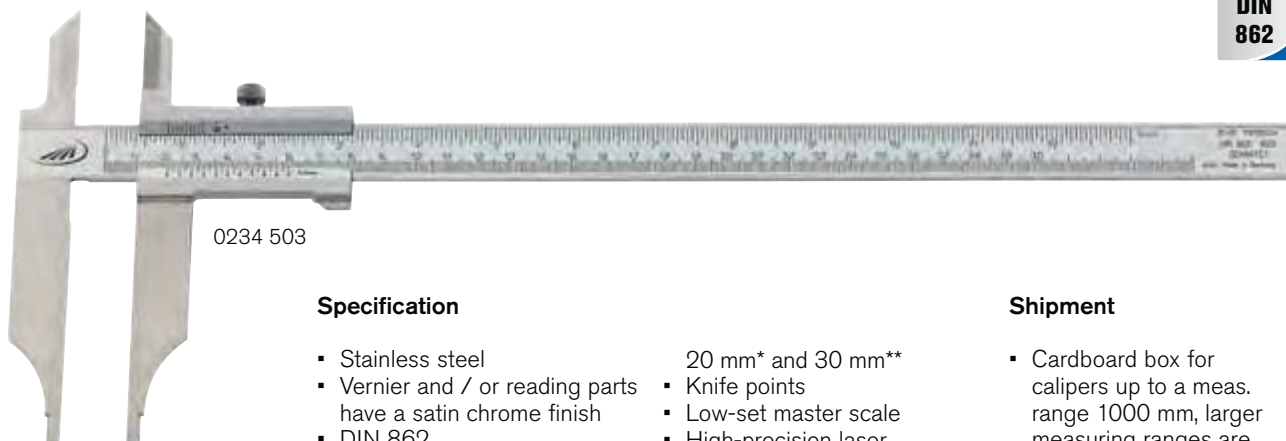

0234 503

### Specification

- Stainless steel
- Vernier and / or reading parts have a satin chrome finish
- DIN 862
- Locking screw
- Stepped jaws for inside measurement: 10 mm, 20 mm\* and 30 mm\*\*
- Knife points
- Low-set master scale
- High-precision laser graduation on the vernier and scale

### Shipment

- Cardboard box for calipers up to a meas. range 1000 mm, larger measuring ranges are individually packed

		Measuring range		Jaw length		Reading		Ref. No.	List price Euro
		mm	inch	mm	inch	mm	inch		
<b>Vernier satin chrome finished</b>									
▪		200	8	80	3.0	0.05	1/128	0234 201	101.00
▪		250	10	80	3.0	0.05	1/128	0234 202	123.00
▪		300	12	90	3.5	0.05	1/128	0234 203	132.00
▪		400	16	125	5.0	0.05		0234 205*	309.00
▪		500	20	150	6.0	0.05		0234 208*	387.00
▪		600	24	150	6.0	0.05		0234 211*	452.00
▪		800	31	150	6.0	0.05		0234 214*	515.00
▪		1000	39	150	6.0	0.05		0234 218*	625.00
	▪	1250	49	200	8.0	0.05		0234 222**	999.00
	▪	1500	59	200	8.0	0.05		0234 224**	1,292.00
	▪	2000	79	200	8.0	0.05		0234 226**	1,886.00
<b>Vernier + scale satin chrome finished</b>									
▪		200	8	80	3.0	0.05	1/128	0234 501	119.00
▪		250	10	80	3.0	0.05	1/128	0234 502	138.00
▪		300	12	90	3.5	0.05	1/128	0234 503	151.00
▪		400	16	125	5.0	0.05		0234 505*	350.00
▪		500	20	150	6.0	0.05		0234 508*	451.00
▪		600	24	150	6.0	0.05		0234 511*	512.00
▪		800	31	150	6.0	0.05		0234 514*	580.00
▪		1000	39	150	6.0	0.05		0234 518*	697.00
	▪	1250	49	200	8.0	0.05		0234 522**	1,138.00
	▪	1500	59	200	8.0	0.05		0234 524**	1,464.00
	▪	2000	79	200	8.0	0.05		0234 526**	2,143.00

Jean Louis MENEGON - Votre représentant et Conseiller- Tél. : 06 76 08 96 83  
E-mail: [jlouismenegon@aol.com](mailto:jlouismenegon@aol.com) - web: [www.menegon-metrologie.com](http://www.menegon-metrologie.com)





## 0235 Workshop calipers



**DIN  
862**

1

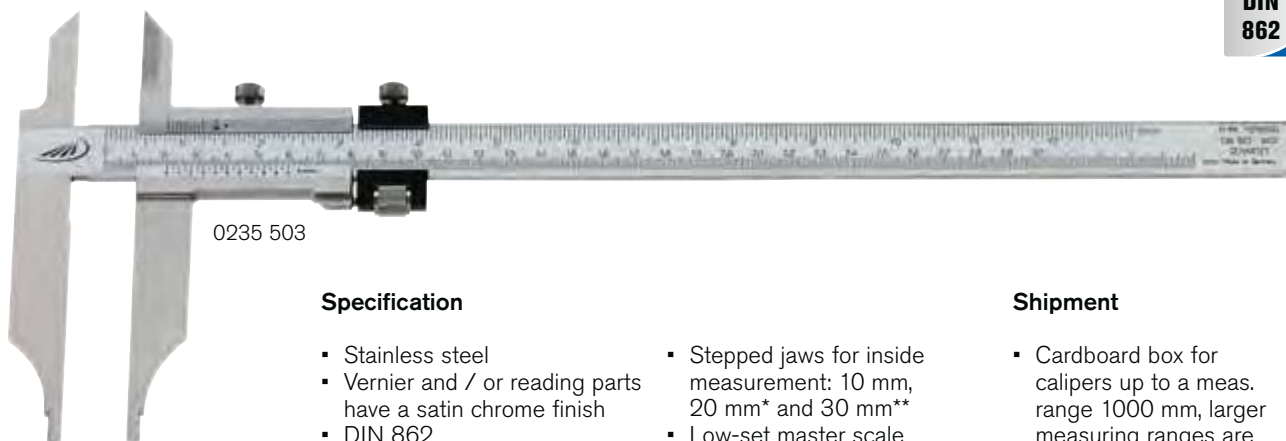

0235 503

### Specification

- Stainless steel
- Vernier and / or reading parts have a satin chrome finish
- DIN 862
- Locking screw
- Knife points
- Fine adjustment
- Stepped jaws for inside measurement: 10 mm, 20 mm\* and 30 mm\*\*
- Low-set master scale
- High-precision laser graduation on the vernier and scale

### Shipment

- Cardboard box for calipers up to a meas. range 1000 mm, larger measuring ranges are individually packed

		Measuring range		Jaw length		Reading		Ref. No.	List price Euro
		mm	inch	mm	inch	mm	inch		
<b>Vernier satin chrome finished</b>									
▪		200	8	80	3.0	0.05	1/128	0235 201	127.00
▪		250	10	80	3.0	0.05	1/128	0235 202	147.00
▪		300	12	90	3.5	0.05	1/128	0235 203	155.00
▪		400	16	125	5.0	0.05		0235 205*	357.00
▪		500	20	150	6.0	0.05		0235 208*	435.00
▪		600	24	150	6.0	0.05		0235 211*	499.00
▪		800	31	150	6.0	0.05		0235 214*	572.00
▪		1000	39	150	6.0	0.05		0235 218*	666.00
	▪	1250	49	200	8.0	0.05		0235 222**	1,093.00
	▪	1500	59	200	8.0	0.05		0235 224**	1,381.00
	▪	2000	79	200	8.0	0.05		0235 226**	2,039.00
<b>Vernier + scale satin chrome finished</b>									
▪		200	8	80	3.0	0.05	1/128	0235 501	136.00
▪		250	10	80	3.0	0.05	1/128	0235 502	163.00
▪		300	12	90	3.5	0.05	1/128	0235 503	174.00
▪		400	16	125	5.0	0.05		0235 505*	397.00
▪		500	20	150	6.0	0.05		0235 508*	488.00
▪		600	24	150	6.0	0.05		0235 511*	555.00
▪		800	31	150	6.0	0.05		0235 514*	639.00
▪		1000	39	150	6.0	0.05		0235 518*	755.00
	▪	1250	49	200	8.0	0.05		0235 522**	1,220.00
	▪	1500	59	200	8.0	0.05		0235 524**	1,552.00
	▪	2000	79	200	8.0	0.05		0235 526**	2,287.00

Jean Louis MENEGON - Votre représentant et Conseiller- Tél. : 06 76 08 96 83

E-mail: [jlouismenegon@aol.com](mailto:jlouismenegon@aol.com) - web: [www.menegon-metrologie.com](http://www.menegon-metrologie.com)





## 0236 Workshop calipers



DIN  
862

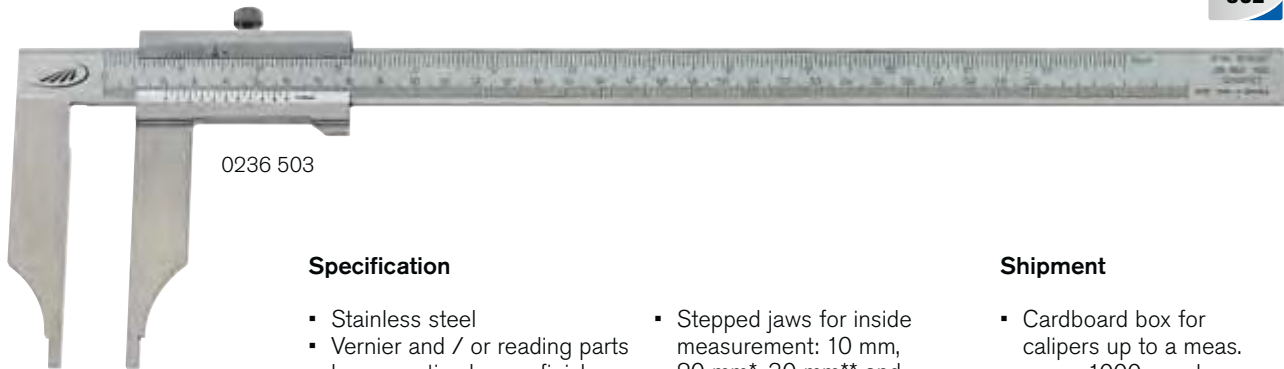

0236 503

### Specification

- Stainless steel
- Vernier and / or reading parts have a satin chrome finish
- DIN 862
- Locking screw
- Low-set master scale
- Stepped jaws for inside measurement: 10 mm, 20 mm\*, 30 mm\*\* and 50 mm (0236 230)
- High-precision laser graduation on the vernier and scale

### Shipment

- Cardboard box for calipers up to a meas. range 1000 mm, larger measuring ranges are individually packed

		Measuring range		Jaw length		Reading		Ref. No.	List price Euro
		mm	inch	mm	inch	mm	inch		
<b>Vernier satin chrome finished</b>									
▪		200	8	80	3.0	0.05	1/128	0236 201	87.00
▪		250	10	80	3.0	0.05	1/128	0236 202	106.00
▪		300	12	90	3.5	0.05	1/128	0236 203	119.00
▪		400	16	125	5.0	0.05		0236 205*	244.00
▪		500	20	150	6.0	0.05		0236 208*	322.00
▪		600	24	150	6.0	0.05		0236 211*	386.00
▪		800	31	150	6.0	0.05		0236 214*	412.00
▪		1000	39	150	6.0	0.05		0236 218*	515.00
	▪	1250	49	200	8.0	0.05		0236 222**	797.00
	▪	1500	59	200	8.0	0.05		0236 224**	1,087.00
	▪	2000	79	200	8.0	0.05		0236 226**	1,498.00
	▪	3000***	118	200	8.0	0.05		0236 230	2,477.00
<b>Vernier + scale satin chrome finished</b>									
▪		200	8	80	3.0	0.05	1/128	0236 501	99.00
▪		250	10	80	3.0	0.05	1/128	0236 502	125.00
▪		300	12	90	3.5	0.05	1/128	0236 503	135.00
▪		400	16	125	5.0	0.05		0236 505*	286.00
▪		500	20	150	6.0	0.05		0236 508*	376.00
▪		600	24	150	6.0	0.05		0236 511*	449.00
▪		800	31	150	6.0	0.05		0236 514*	466.00
▪		1000	39	150	6.0	0.05		0236 518*	581.00
	▪	1250	49	200	8.0	0.05		0236 522**	955.00
	▪	1500	59	200	8.0	0.05		0236 524**	1,281.00
	▪	2000	79	200	8.0	0.05		0236 526**	1,931.00

\*\*\* = Factory standard

Jean Louis MENEGON - Votre représentant et Conseiller- Tél. : 06 76 08 96 83

E-mail: [jlouismenegon@aol.com](mailto:jlouismenegon@aol.com) - web: [www.menegon-metrologie.com](http://www.menegon-metrologie.com)



## 0236 Workshop calipers with long measuring jaws

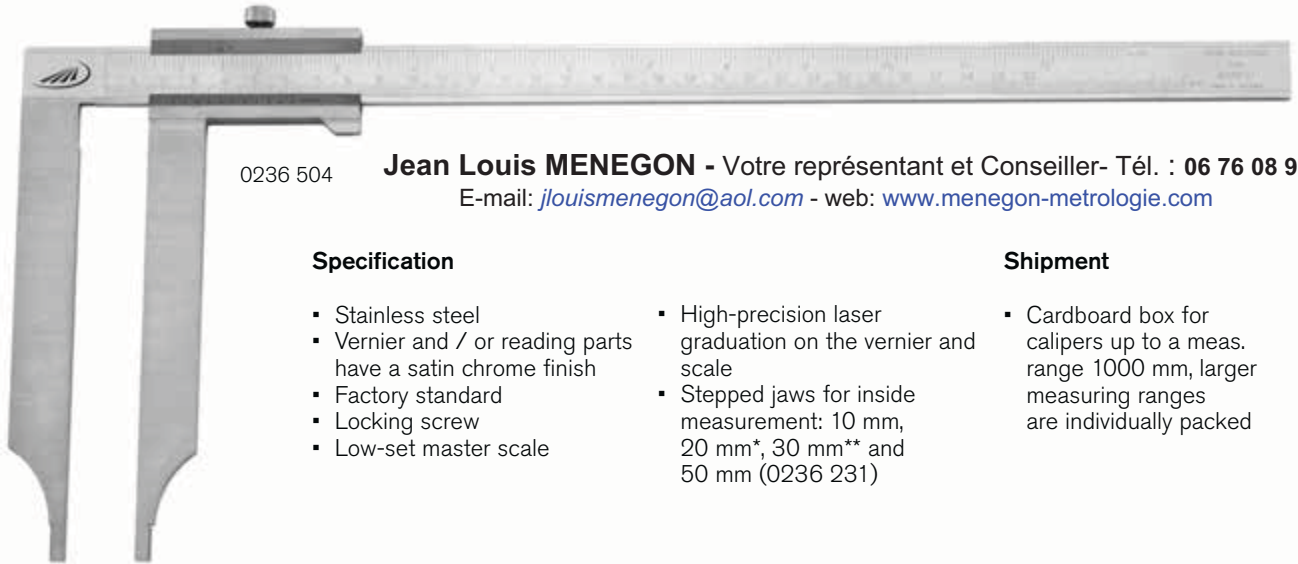

0236 504

**Jean Louis MENEGON** - Votre représentant et Conseiller- Tél. : 06 76 08 96 83

E-mail: [jlouismenegon@aol.com](mailto:jlouismenegon@aol.com) - web: [www.menegon-metrologie.com](http://www.menegon-metrologie.com)

### Specification

- Stainless steel
- Vernier and / or reading parts have a satin chrome finish
- Factory standard
- Locking screw
- Low-set master scale
- High-precision laser graduation on the vernier and scale
- Stepped jaws for inside measurement: 10 mm, 20 mm\*, 30 mm\*\* and 50 mm (0236 231)

### Shipment

- Cardboard box for calipers up to a meas. range 1000 mm, larger measuring ranges are individually packed

		Measuring range		Jaw length		Reading		Ref. No.	List price Euro
		mm	inch	mm	inch	mm	inch		
<b>Vernier satin chrome finished</b>									
		300	12	150	6.0	0.05	1/128	0236 204	221.00
		400	16	150	5.0	0.05		0236 206*	315.00
		400	16	200	8.0	0.05		0236 207*	384.00
		500	20	200	8.0	0.05		0236 209*	427.00
		500	20	250	10.0	0.05		0236 210*	515.00
		600	24	200	8.0	0.05		0236 212*	536.00
		600	24	300	12.0	0.05		0236 213*	659.00
		800	31	200	8.0	0.05		0236 215*	620.00
		800	31	300	12.0	0.05		0236 216*	793.00
		800	31	400	16.0	0.05		0236 217*	921.00
		1000	39	200	8.0	0.05		0236 219*	761.00
		1000	39	300	12.0	0.05		0236 220*	850.00
		1000	39	500	20.0	0.05		0236 221*	1,281.00
	▪	1500	59	300	12.0	0.05		0236 225**	1,314.00
	▪	2000	79	300	12.0	0.05		0236 227**	1,828.00
	▪	3000	118	300	12.0	0.05		0236 231	3,021.00
<b>Vernier + scale satin chrome finished</b>									
		300	12	150	6.0	0.05	1/128	0236 504	239.00
		400	16	150	6.0	0.05		0236 506*	367.00
		400	16	200	8.0	0.05		0236 507*	446.00
		500	20	200	8.0	0.05		0236 509*	495.00
		500	20	250	10.0	0.05		0236 510*	591.00
		600	24	200	8.0	0.05		0236 512*	559.00
		600	24	300	12.0	0.05		0236 513*	728.00
		800	31	200	8.0	0.05		0236 515*	720.00
		800	31	300	12.0	0.05		0236 516*	918.00
		800	31	400	16.0	0.05		0236 517*	1,077.00
		1000	39	200	8.0	0.05		0236 519*	883.00
		1000	39	300	12.0	0.05		0236 520*	1,114.00
		1000	39	500	20.0	0.05		0236 521*	1,522.00
	▪	1500	59	300	12.0	0.05		0236 525**	1,563.00
	▪	2000	79	300	12.0	0.05		0236 527**	2,315.00



## 0237 Workshop calipers



DIN  
862

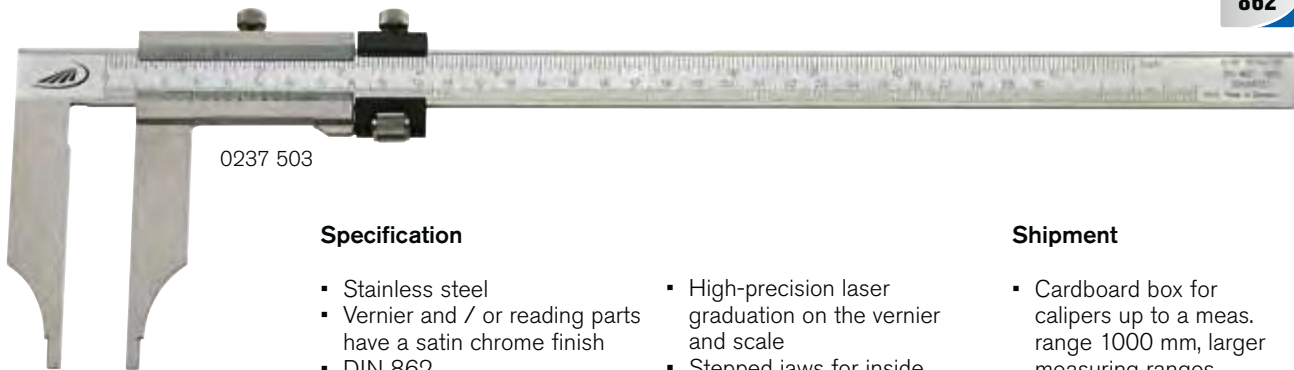

0237 503

### Specification

- Stainless steel
- Vernier and / or reading parts have a satin chrome finish
- DIN 862
- Locking screw
- Fine adjustment
- Low-set master scale
- High-precision laser graduation on the vernier and scale
- Stepped jaws for inside measurement: 10 mm, 20 mm\*, 30 mm\*\* and 50 mm (0237 230)

### Shipment

- Cardboard box for calipers up to a meas. range 1000 mm, larger measuring ranges are individually packed

		Measuring range		Jaw length		Reading		Ref. No.	List price Euro
		mm	inch	mm	inch	mm	inch		
<b>Vernier satin chrome finished</b>									
▪		200	8	80	3.0	0.05	1/128	0237 201	112.00
▪		250	10	80	3.0	0.05	1/128	0237 202	132.00
▪		300	12	90	3.5	0.05	1/128	0237 203	144.00
▪		400	16	125	5.0	0.05		0237 205*	293.00
▪		500	20	150	6.0	0.05		0237 208*	372.00
▪		600	24	150	6.0	0.05		0237 211*	435.00
▪		800	31	150	6.0	0.05		0237 214*	469.00
▪		1000	39	150	6.0	0.05		0237 218*	572.00
	▪	1250	49	200	8.0	0.05		0237 222**	887.00
	▪	1500	59	200	8.0	0.05		0237 224**	1,178.00
	▪	2000	79	200	8.0	0.05		0237 226**	1,646.00
	▪	3000***	118	200	8.0	0.05		0237 230	2,692.00
<b>Vernier + scale satin chrome finished</b>									
▪		200	8	80	3.0	0.05	1/128	0237 501	122.00
▪		250	10	80	3.0	0.05	1/128	0237 502	149.00
▪		300	12	90	3.5	0.05	1/128	0237 503	161.00
▪		400	16	125	5.0	0.05		0237 505*	334.00
▪		500	20	150	6.0	0.05		0237 508*	423.00
▪		600	24	150	6.0	0.05		0237 511*	495.00
▪		800	31	150	6.0	0.05		0237 514*	524.00
▪		1000	39	150	6.0	0.05		0237 518*	640.00
	▪	1250	49	200	8.0	0.05		0237 522**	1,042.00
	▪	1500	59	200	8.0	0.05		0237 524**	1,371.00
	▪	2000	79	200	8.0	0.05		0237 526**	2,077.00

\*\*\* = Factory standard

Jean Louis MENEGON - Votre représentant et Conseiller- Tél. : 06 76 08 96 83

E-mail: [jlouismenegon@aol.com](mailto:jlouismenegon@aol.com) - web: [www.menegon-metrologie.com](http://www.menegon-metrologie.com)





## 0237 Workshop calipers with long measuring jaws

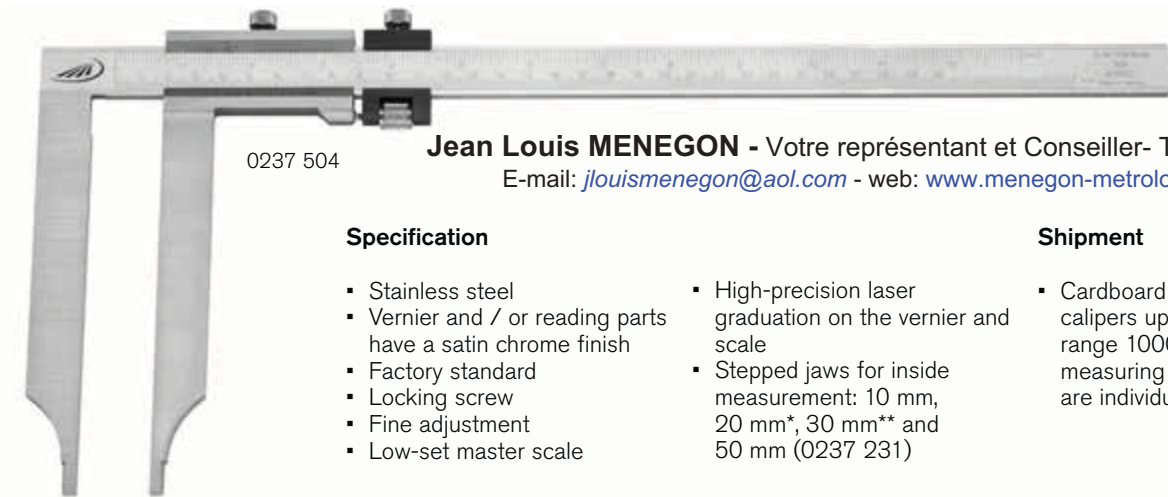

0237 504

Jean Louis MENEGON - Votre représentant et Conseiller- Tél. : 06 76 08 96 83

E-mail: [jlouismenegon@aol.com](mailto:jlouismenegon@aol.com) - web: [www.menegon-metrologie.com](http://www.menegon-metrologie.com)

### Specification

- Stainless steel
- Vernier and / or reading parts have a satin chrome finish
- Factory standard
- Locking screw
- Fine adjustment
- Low-set master scale
- High-precision laser graduation on the vernier and scale
- Stepped jaws for inside measurement: 10 mm, 20 mm\*, 30 mm\*\* and 50 mm (0237 231)

### Shipment

- Cardboard box for calipers up to a meas. range 1000 mm, larger measuring ranges are individually packed

		Measuring range		Jaw length		Reading		Ref. No.	List price Euro
		mm	inch	mm	inch	mm	inch		
<b>Vernier satin chrome finished</b>									
		300	12	150	6.0	0.05	1/128	0237 204	245.00
		400	16	150	6.0	0.05		0237 206*	363.00
		400	16	200	8.0	0.05		0237 207*	433.00
		500	20	200	8.0	0.05		0237 209*	477.00
		500	20	250	10.0	0.05		0237 210*	563.00
		600	24	200	8.0	0.05		0237 212*	582.00
		600	24	300	12.0	0.05		0237 213*	708.00
		800	31	200	8.0	0.05		0237 215*	680.00
		800	31	300	12.0	0.05		0237 216*	852.00
		800	31	400	16.0	0.05		0237 217*	981.00
		1000	39	200	8.0	0.05		0237 219*	822.00
		1000	39	300	12.0	0.05		0237 220*	910.00
		1000	39	500	20.0	0.05		0237 221*	1,340.00
	▪	1500	59	300	12.0	0.05		0237 225**	1,405.00
	▪	2000	79	300	12.0	0.05		0237 227**	1,975.00
	▪	3000	118	300	12.0	0.05		0237 231	3,235.00
<b>Vernier + scale satin chrome finished</b>									
		300	12	150	6.0	0.05	1/128	0237 504	262.00
		400	16	150	6.0	0.05		0237 506*	414.00
		400	16	200	8.0	0.05		0237 507*	493.00
		500	20	200	8.0	0.05		0237 509*	541.00
		500	20	250	10.0	0.05		0237 510*	638.00
		600	24	200	8.0	0.05		0237 512*	651.00
		600	24	300	12.0	0.05		0237 513*	777.00
		800	31	200	8.0	0.05		0237 515*	779.00
		800	31	300	12.0	0.05		0237 516*	974.00
		800	31	400	16.0	0.05		0237 517*	1,137.00
		1000	39	200	8.0	0.05		0237 519*	938.00
		1000	39	300	12.0	0.05		0237 520*	1,172.00
		1000	39	500	20.0	0.05		0237 521*	1,582.00
	▪	1500	59	300	12.0	0.05		0237 525**	1,655.00
	▪	2000	79	300	12.0	0.05		0237 527**	2,460.00



## 0219 Workshop dial calipers



DIN 862

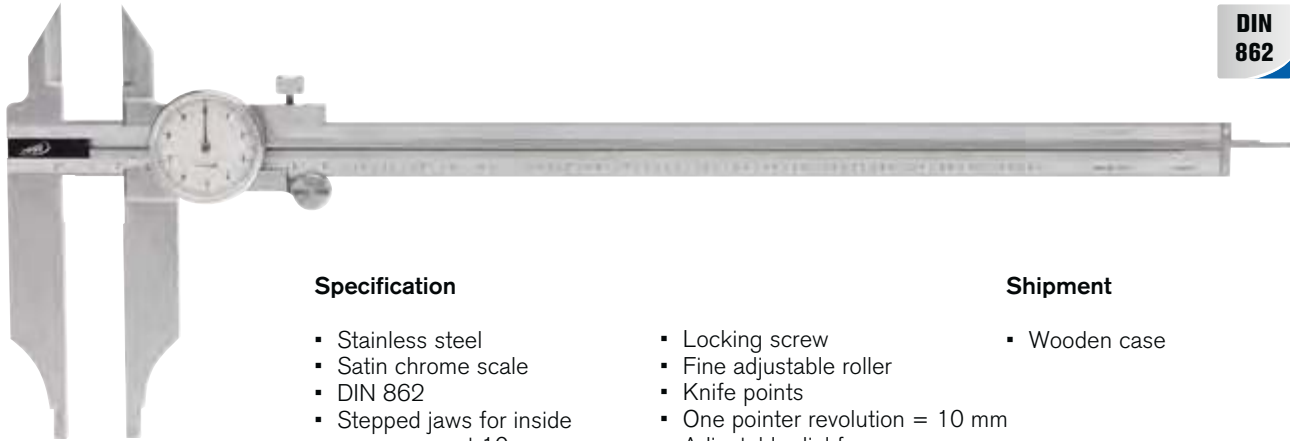

### Specification

- Stainless steel
- Satin chrome scale
- DIN 862
- Stepped jaws for inside measurement 10 mm
- Locking screw
- Fine adjustable roller
- Knife points
- One pointer revolution = 10 mm
- Adjustable dial face

### Shipment

- Wooden case

✂	🏠	Measuring range		Jaw length		Reading		Depth gauge	Ref. No.	List price Euro
		mm	inch	mm	inch	mm				
		300	12	90	3.5	0.05		rectangular	0219 503	277.00

## 0238 Lightweight workshop calipers



Jean Louis MENEGON - Votre représentant et Conseiller- Tél. : 06 76 08 96 83

E-mail: [jlouismenegon@aol.com](mailto:jlouismenegon@aol.com) - web: [www.menegon-metrologie.com](http://www.menegon-metrologie.com)

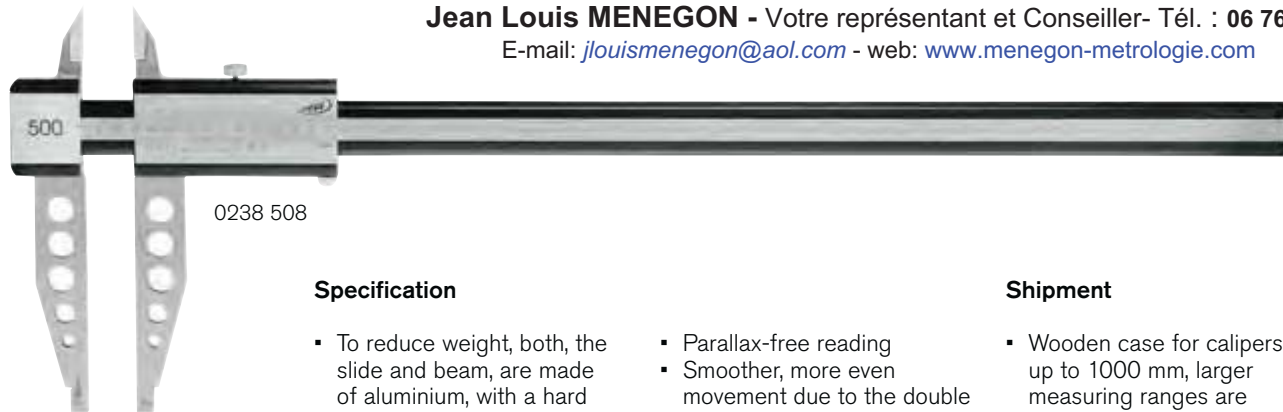

0238 508

### Specification

- To reduce weight, both, the slide and beam, are made of aluminium, with a hard anodized surface coating (1100 HV)
- Measuring faces are made of hardened stainless steel
- Factory standard
- Parallax-free reading
- Smoother, more even movement due to the double V-guide
- Locking screw
- Knife points
- Stepped jaws for inside measurement 20 mm

### Shipment

- Wooden case for calipers up to 1000 mm, larger measuring ranges are packed into cardboard boxes

✂	🏠	Measuring range		Jaw length		Reading		Ref. No.	List price Euro
		mm	inch	mm	inch	mm	mm		
		300	12	90	3.5	0.02	0.02	0238 503	350.00
		500	20	150	6.0	0.02	0.02	0238 508	500.00
		800	31	150	6.0	0.02	0.02	0238 514	669.00
		1000	39	150	6.0	0.02	0.02	0238 518	783.00
	▪	1500	59	200	8.0	0.05	0.05	0238 524	2,031.00
	▪	2000	79	200	8.0	0.05	0.05	0238 526	2,365.00



0265 Caliper with cross points



1

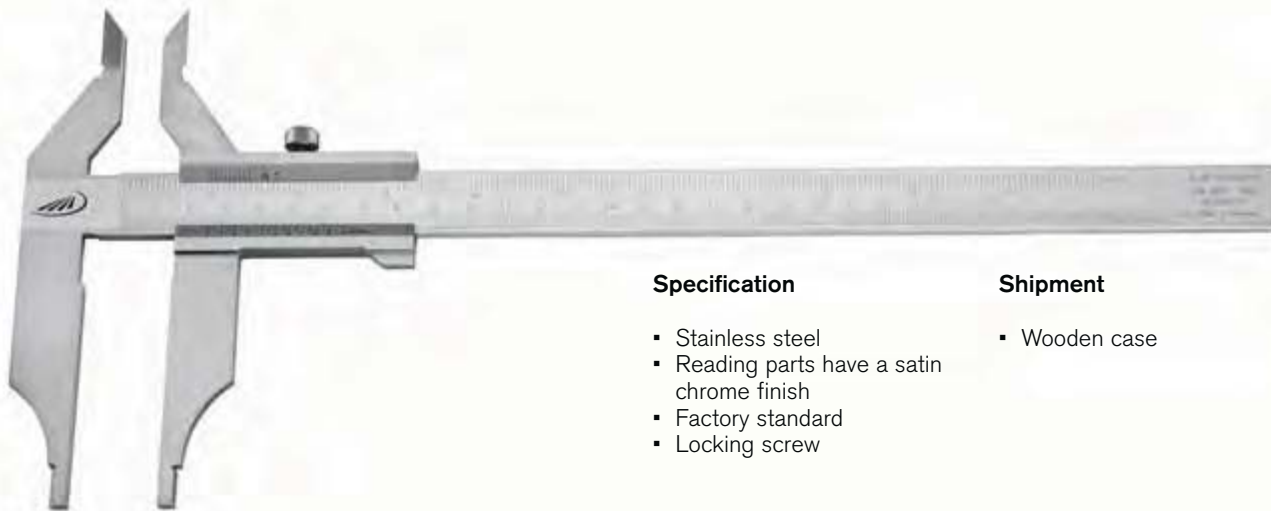

Specification

- Stainless steel
- Reading parts have a satin chrome finish
- Factory standard
- Locking screw

Shipment

- Wooden case

✂	📏	Measuring range		Length of cross points		Jaw Length		Reading		Ref. No.	List price Euro
		mm	inch	mm	inch	mm	inch	mm	inch		
		250	10	55	2.17	80	3.15	0.02	0.001	0265 520 05	249.00

0266 Caliper with gripper points

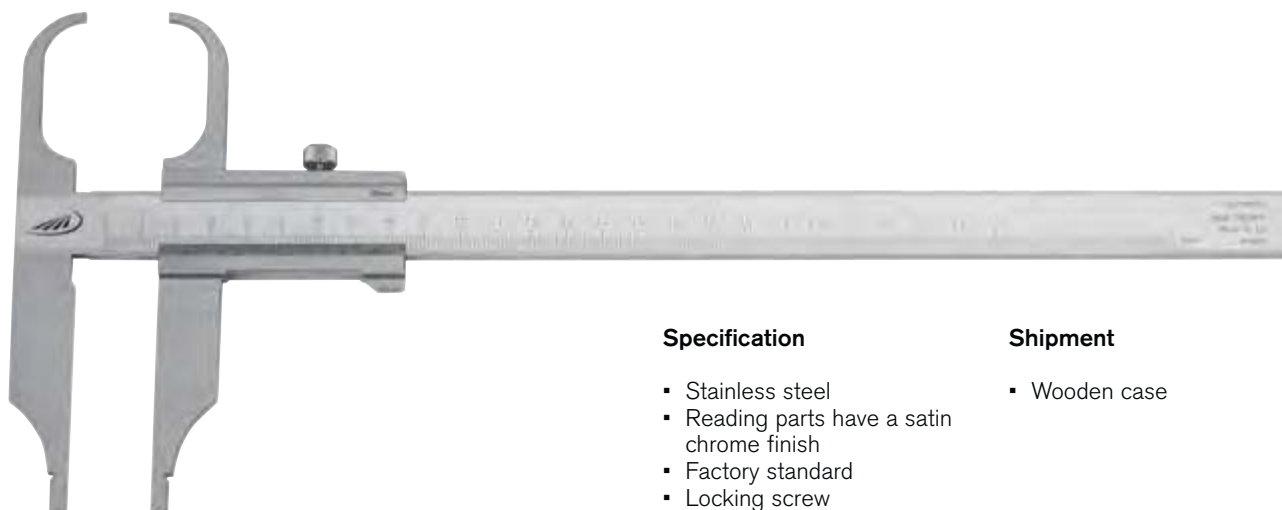

Specification

- Stainless steel
- Reading parts have a satin chrome finish
- Factory standard
- Locking screw

Shipment

- Wooden case

✂	📏	Measuring range		Length of gripper points		Jaw Length		Reading		Ref. No.	List price Euro
		mm	inch	mm	inch	mm	inch	mm	inch		
		250	10	55	2.17	75	3	0.02	0.001	0266 520 05	334.00

Jean Louis MENEGON - Votre représentant et Conseiller- Tél. : 06 76 08 96 83

E-mail: [jlouismenegon@aol.com](mailto:jlouismenegon@aol.com) - web: [www.menegon-metrologie.com](http://www.menegon-metrologie.com)



## 1330 / 1331 DIGI-MET® Workshop caliper



### Specification

- Stainless steel
- Inductive measuring system, resistant to damp and sweat
- DIN 862
- Knife points
- LCD display:  
8.5 mm with measuring range 300 mm,  
12.5 mm from measuring range 500 mm
- Locking screw

### Electronic functions

- ON/OFF switch
- QuickStart** Electronic
- QuickLock** Function
- Zero setting at any position
- mm/inch conversion
- Variable data output  
RS 232 + Digimatic + USB
- PRESET Function (setting a numerical value)

### Shipment

- Wooden case

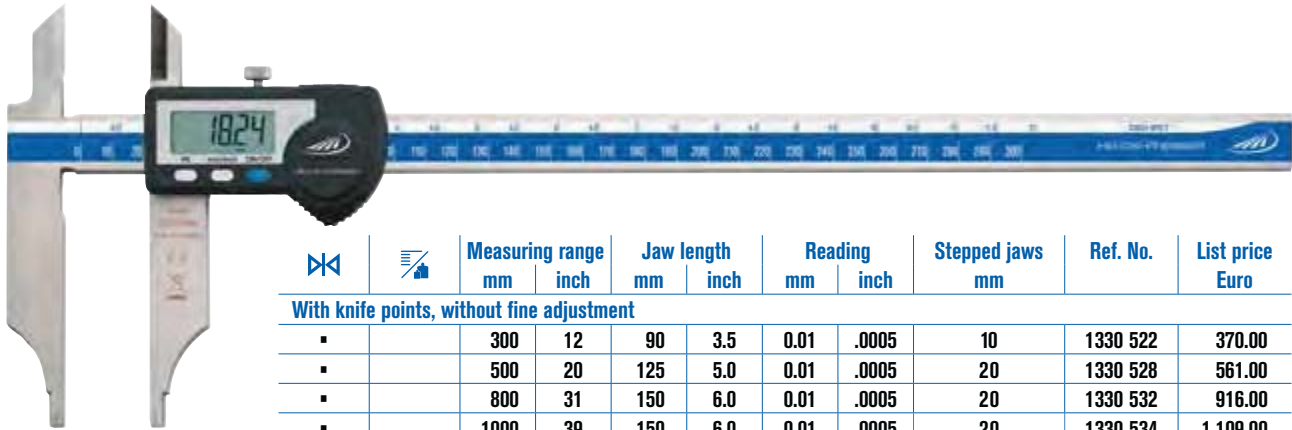

	⌘	☰	Measuring range		Jaw length		Reading		Stepped jaws mm	Ref. No.	List price Euro
			mm	inch	mm	inch	mm	inch			
<b>With knife points, without fine adjustment</b>											
▪			300	12	90	3.5	0.01	.0005	10	1330 522	370.00
▪			500	20	125	5.0	0.01	.0005	20	1330 528	561.00
▪			800	31	150	6.0	0.01	.0005	20	1330 532	916.00
▪			1000	39	150	6.0	0.01	.0005	20	1330 534	1,109.00

**Jean Louis MENEGON** - Votre représentant et Conseiller- Tél. : 06 76 08 96 83

E-mail: [jlouismenegon@aol.com](mailto:jlouismenegon@aol.com) - web: [www.menegon-metrologie.com](http://www.menegon-metrologie.com)

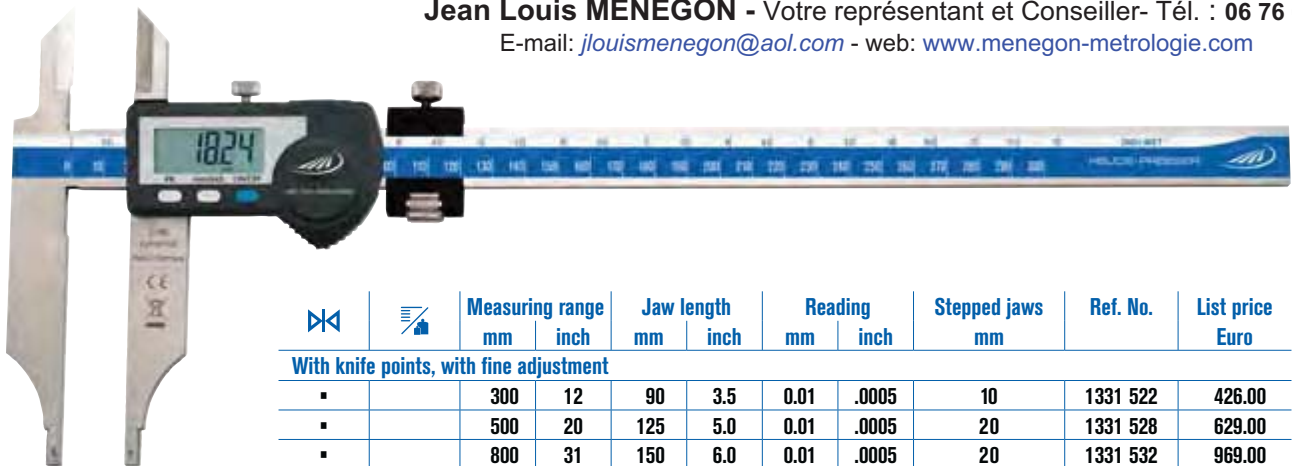

	⌘	☰	Measuring range		Jaw length		Reading		Stepped jaws mm	Ref. No.	List price Euro
			mm	inch	mm	inch	mm	inch			
<b>With knife points, with fine adjustment</b>											
▪			300	12	90	3.5	0.01	.0005	10	1331 522	426.00
▪			500	20	125	5.0	0.01	.0005	20	1331 528	629.00
▪			800	31	150	6.0	0.01	.0005	20	1331 532	969.00
▪			1000	39	150	6.0	0.01	.0005	20	1331 534	1,114.00

### Accessories

	Ref. No.	List price Euro
Battery, 3V-Lithium, CR 2032	0220 704	3.60
Cable for USB, incl. software	1998 720	66.00
Cable for RS 232	1997 501	46.20
Cable for Digimatic	1998 501	59.00



# HELIOS • PREISSER

## 1334 / 1335 DIGI-MET® Workshop calipers



### Specification

- Stainless steel
- Inductive measuring system, resistant to damp and sweat
- DIN 862
- LCD display: 8.5 mm with measuring range 300 mm, 12.5 mm from measuring range 500 mm
- Locking screw

### Electronic functions

- ON/OFF switch
- **QuickStart** Electronic
- **QuickLock** Function
- Zero setting at any position
- mm/inch conversion
- Variable data output RS 232 + Digimatic + USB
- **PRESET** Function (setting a numerical value)

### Shipment

- Wooden case



1

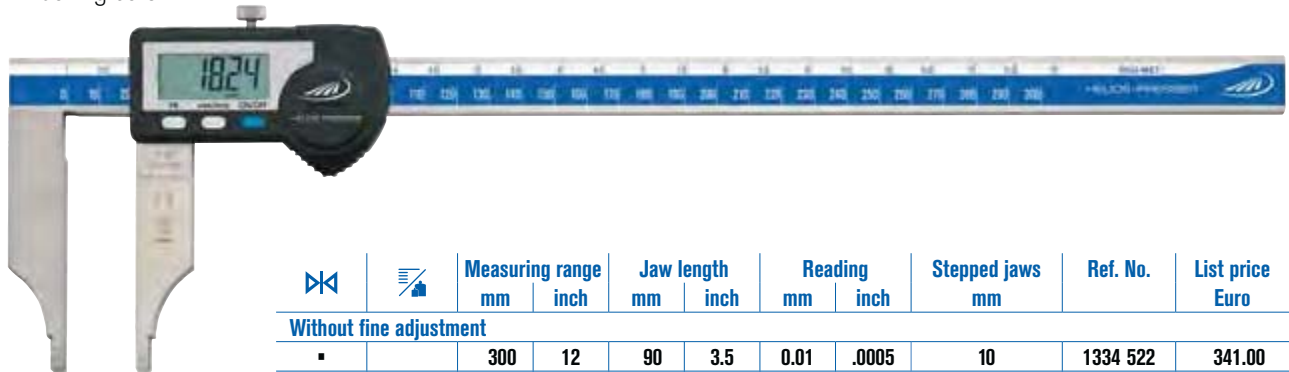

	⏏	☒	Measuring range		Jaw length		Reading		Stepped jaws mm	Ref. No.	List price Euro
			mm	inch	mm	inch	mm	inch			
<b>Without fine adjustment</b>											
▪			300	12	90	3.5	0.01	.0005	10	1334 522	341.00
▪			500	20	125	5.0	0.01	.0005	20	1334 528	478.00
▪			800	31	150	6.0	0.01	.0005	20	1334 532	836.00
▪			1000	39	150	6.0	0.01	.0005	20	1334 534	989.00

**Jean Louis MENEGON** - Votre représentant et Conseiller- Tél. : 06 76 08 96 83

E-mail: [jlouismenegon@aol.com](mailto:jlouismenegon@aol.com) - web: [www.menegon-metrologie.com](http://www.menegon-metrologie.com)

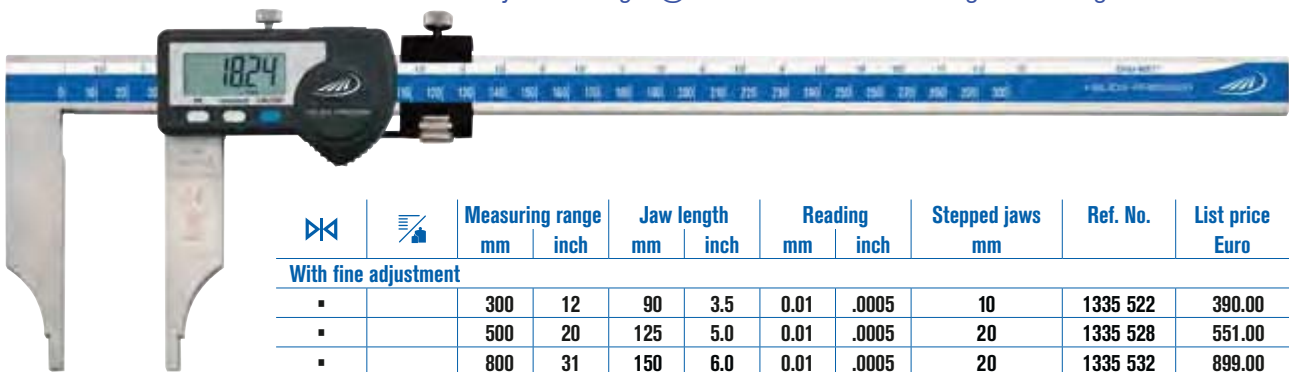

	⏏	☒	Measuring range		Jaw length		Reading		Stepped jaws mm	Ref. No.	List price Euro
			mm	inch	mm	inch	mm	inch			
<b>With fine adjustment</b>											
▪			300	12	90	3.5	0.01	.0005	10	1335 522	390.00
▪			500	20	125	5.0	0.01	.0005	20	1335 528	551.00
▪			800	31	150	6.0	0.01	.0005	20	1335 532	899.00
▪			1000	39	150	6.0	0.01	.0005	20	1335 534	1,033.00

### Accessories

	Ref. No.	List price Euro
Battery, 3V-Lithium, CR 2032	0220 704	3.60
Cable for USB, incl. software	1998 720	66.00
Cable for RS 232	1997 501	46.20
Cable for Digimatic	1998 501	59.00





## 1340 / 1341 DIGI-MET® Workshop calipers IP65



### Specification

- Stainless steel
- Inductive measuring system, protection class IP65
- DIN 862
- Knife points
- LCD display:  
8.5 mm with measuring range 300 mm,  
12.5 mm from measuring range 500 mm
- Locking screw

### Electronic functions

- ON/OFF switch
- QuickStart** Electronic
- QuickLock** Function
- Zero-setting at any position
- mm/inch-conversion
- Variable data output RS 232 + Digimatic + USB
- PRESET Function (setting a numerical value)

### Shipment

- Wooden case

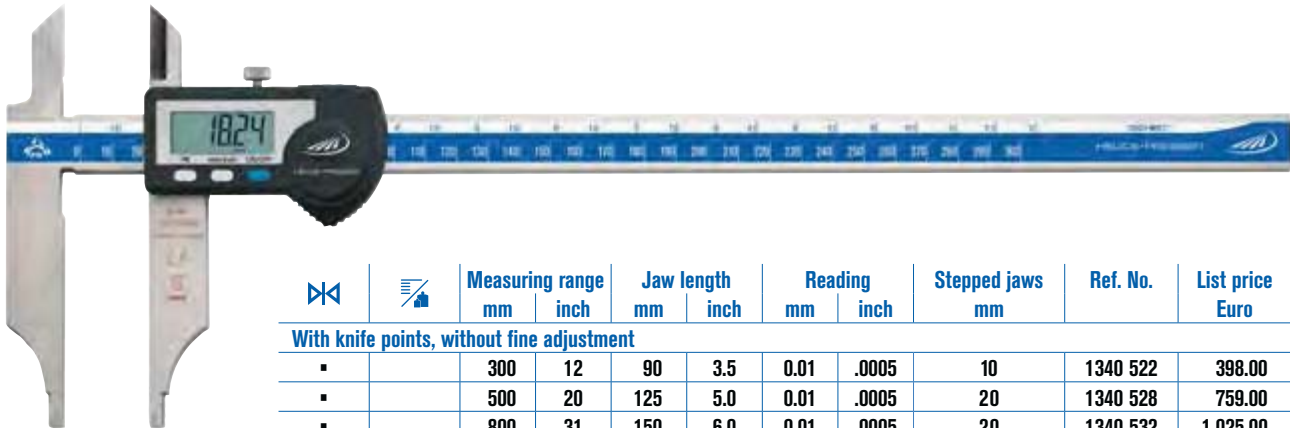

Icon	Icon	Measuring range		Jaw length		Reading		Stepped jaws mm	Ref. No.	List price Euro
		mm	inch	mm	inch	mm	inch			
<b>With knife points, without fine adjustment</b>										
▪		300	12	90	3.5	0.01	.0005	10	1340 522	398.00
▪		500	20	125	5.0	0.01	.0005	20	1340 528	759.00
▪		800	31	150	6.0	0.01	.0005	20	1340 532	1,025.00
▪		1000	39	150	6.0	0.01	.0005	20	1340 534	1,261.00

Jean Louis MENEGON - Votre représentant et Conseiller- Tél. : 06 76 08 96 83

E-mail: [jlouismenegon@aol.com](mailto:jlouismenegon@aol.com) - web: [www.menegon-metrologie.com](http://www.menegon-metrologie.com)

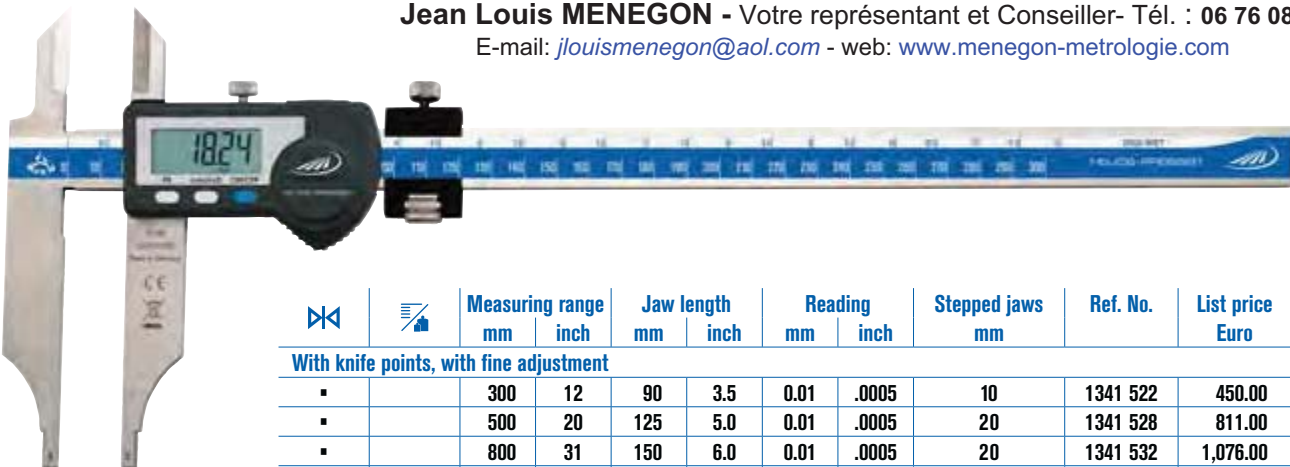

Icon	Icon	Measuring range		Jaw length		Reading		Stepped jaws mm	Ref. No.	List price Euro
		mm	inch	mm	inch	mm	inch			
<b>With knife points, with fine adjustment</b>										
▪		300	12	90	3.5	0.01	.0005	10	1341 522	450.00
▪		500	20	125	5.0	0.01	.0005	20	1341 528	811.00
▪		800	31	150	6.0	0.01	.0005	20	1341 532	1,076.00
▪		1000	39	150	6.0	0.01	.0005	20	1341 534	1,312.00

### Accessories

	Ref. No.	List price Euro
Battery, 3V-Lithium, CR 2032	0220 704	3.60
Cable for USB, incl. software	1998 720	66.00
Cable for RS 232	1997 501	46.20
Cable for Digimatic	1998 501	59.00



# HELIOS • PREISSER

## 1342 / 1343 DIGI-MET® Workshop calipers IP65



### Specification

- Stainless steel
- Inductive measuring system, protection class IP65
- DIN 862
- LCD display:  
8.5 mm with measuring range 300 mm,  
12.5 mm from measuring range 500 mm
- Locking screw

### Electronic functions

- ON/OFF switch
- **QuickStart** Electronic
- **QuickLock** Function
- Zero-setting at any position
- mm/inch-conversion
- Variable data output  
RS 232 + Digimatic + USB
- PRESET Function (setting a numerical value)

### Shipment

- Wooden case



1

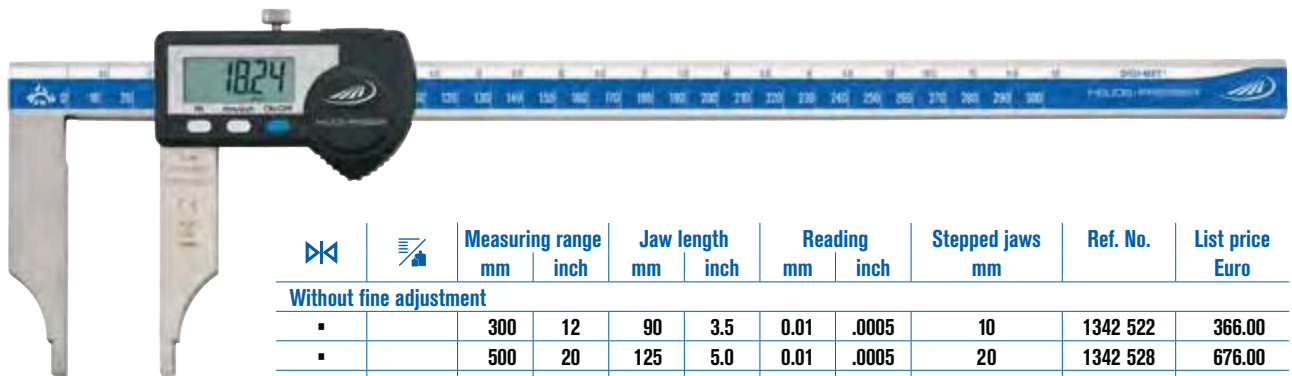

	Measuring range	Jaw length	Reading		Stepped jaws	Ref. No.	List price		
			mm	inch				mm	inch
<b>Without fine adjustment</b>									
▪	300	12	90	3.5	0.01	.0005	10	1342 522	366.00
▪	500	20	125	5.0	0.01	.0005	20	1342 528	676.00
▪	800	31	150	6.0	0.01	.0005	20	1342 532	935.00
▪	1000	39	150	6.0	0.01	.0005	20	1342 534	1,163.00

Jean Louis MENEGON - Votre représentant et Conseiller- Tél. : 06 76 08 96 83  
E-mail: [jlouismenegon@aol.com](mailto:jlouismenegon@aol.com) - web: [www.menegon-metrologie.com](http://www.menegon-metrologie.com)

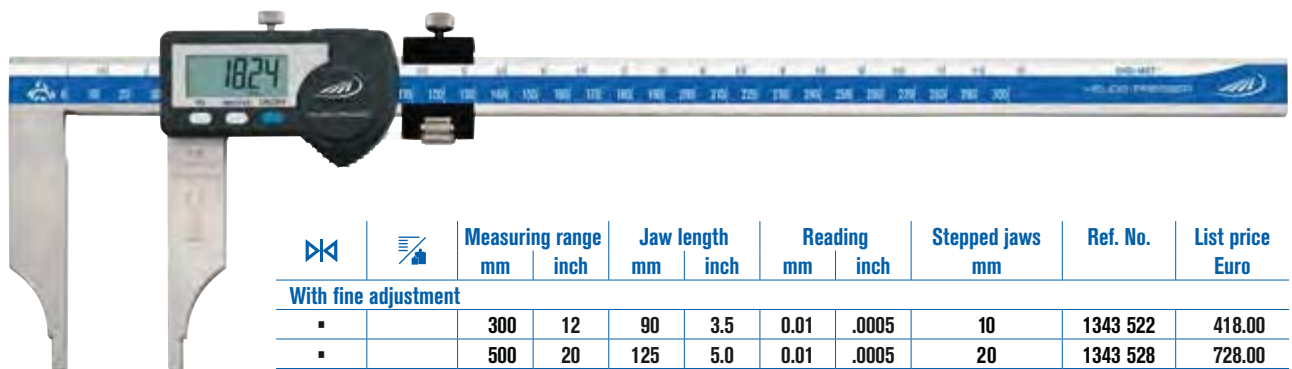

	Measuring range	Jaw length	Reading		Stepped jaws	Ref. No.	List price		
			mm	inch				mm	inch
<b>With fine adjustment</b>									
▪	300	12	90	3.5	0.01	.0005	10	1343 522	418.00
▪	500	20	125	5.0	0.01	.0005	20	1343 528	728.00
▪	800	31	150	6.0	0.01	.0005	20	1343 532	987.00
▪	1000	39	150	6.0	0.01	.0005	20	1343 534	1,214.00

### Accessories

	Ref. No.	List price
Battery, 3V-Lithium, CR 2032	0220 704	3.60
Cable for USB, incl. software	1998 720	66.00
Cable for RS 232	1997 501	46.20
Cable for Digimatic	1998 501	59.00



## 0222 / 0223 DIGI-MET® Workshop calipers long version



### Specification

- Stainless steel
- LCD display 8.5 mm
- Locking screw
- Knife points
- Factory standard

### Electronic functions

- ON/OFF switch
- Zero setting at any position
- mm/inch conversion
- Data output Opto RS 232
- Hold Function
- PRESET Function (setting a numerical value)

### Shipment

- Wooden case

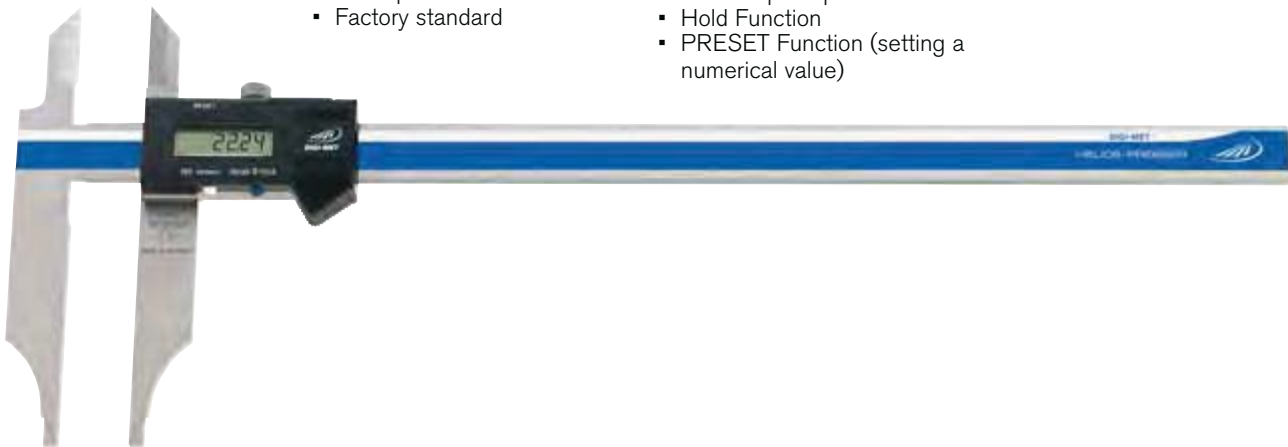

✂	📏	Measuring range		Jaw length		Reading		Stepped jaws mm	Ref. No.	List price Euro
		mm	inch	mm	inch	mm	inch			
<b>With knife points, without fine adjustment</b>										
	▪	1500	59	200	8.0	0.01	.0005	30	0222 734	2,473.00
	▪	2000	79	200	8.0	0.01	.0005	30	0222 736	2,967.00



Jean Louis MENEGON - Votre représentant et Conseiller- Tél. : 06 76 08 96 83

E-mail: [jlouismenegon@aol.com](mailto:jlouismenegon@aol.com) - web: [www.menegon-metrologie.com](http://www.menegon-metrologie.com)

✂	📏	Measuring range		Jaw length		Reading		Stepped jaws mm	Ref. No.	List price Euro
		mm	inch	mm	inch	mm	inch			
<b>With knife points, with fine adjustment</b>										
	▪	1500	59	200	8.0	0.01	.0005	30	0223 734	2,638.00
	▪	2000	79	200	8.0	0.01	.0005	30	0223 736	3,057.00

### Accessories

	Ref. No.	List price Euro
Battery, 3V-Lithium, CR 2032	0220 704	3.60
Cable for Opto to RS 232	0996 701	71.00
Cable for Opto to USB	0996 705	136.00
USB-keyboard interface cable Opto RS 232	0997 770	232.00



# HELIOS • PREISSER

## 0224 / 0225 DIGI-MET® Workshop calipers long version



### Specification

- Stainless steel
- LCD display 8.5 mm
- Locking screw
- Without knife points
- Factory standard

### Electronic functions

- ON/OFF switch
- Zero setting at any position
- mm/inch conversion
- Data output Opto RS 232
- Hold Function
- PRESET Function (setting a numerical value)

### Shipment

- Wooden case

1



	QuickLock	QuickStart	Measuring range		Jaw length		Reading		Stepped jaws	Ref. No.	List price
			mm	inch	mm	inch	mm	inch			
<b>Without fine adjustment</b>											
	▪		1500	59	200	8.0	0.01	.0005	30	0224 734	2,236.00
	▪		2000	79	200	8.0	0.01	.0005	30	0224 736	2,710.00



**Jean Louis MENEGON** - Votre représentant et Conseiller- Tél. : 06 76 08 96 83  
E-mail: [jlouismenegon@aol.com](mailto:jlouismenegon@aol.com) - web: [www.menegon-metrologie.com](http://www.menegon-metrologie.com)

	QuickLock	QuickStart	Measuring range		Jaw length		Reading		Stepped jaws	Ref. No.	List price
			mm	inch	mm	inch	mm	inch			
<b>With fine adjustment</b>											
	▪		1500	59	200	8.0	0.01	.0005	30	0225 734	2,357.00
	▪		2000	79	200	8.0	0.01	.0005	30	0225 736	2,798.00

### Accessories

	Ref. No.	List price
Battery, 3V-Lithium, CR 2032	0220 704	3.60
Cable for Opto to RS 232	0996 701	71.00
Cable for Opto to USB	0996 705	136.00
USB-keyboard interface cable Opto RS 232	0997 770	232.00



## 1351 DIGI-MET® Workshop calipers with cross points



### Specification

- Stainless steel
- DIN 862
- LCD display:  
8.5 mm with measuring range 300 mm  
12.5 mm with measuring range 500 mm
- Locking screw
- Inside cross points
- Three way measurement

### Electronic functions

- ON/OFF switch
- **QuickStart** Electronic
- **QuickLock** Function
- Zero setting at any position
- mm/inch conversion
- Variable data output RS 232 + Digimatic + USB
- **PRESET** Function (setting a numerical value)

### Shipment

- Wooden case

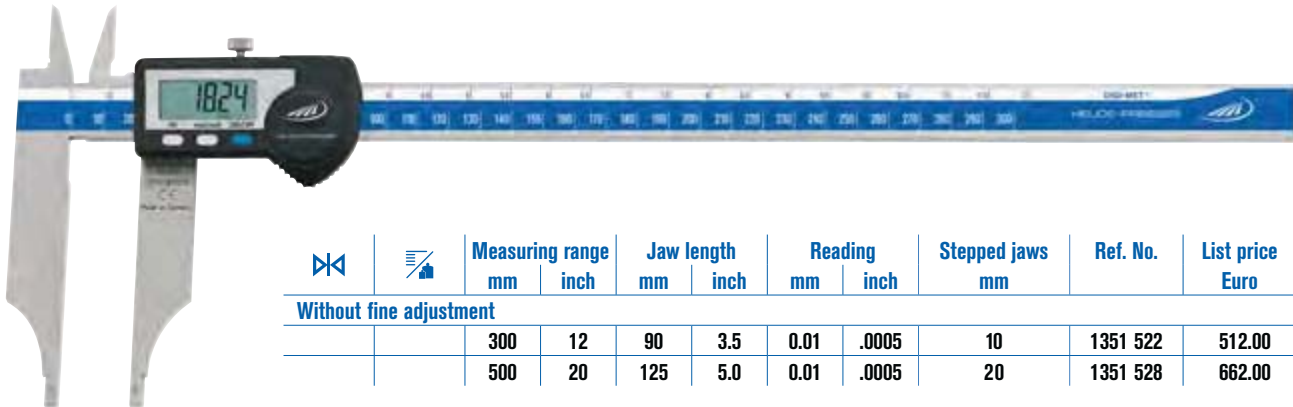

	⏏	📏	Measuring range		Jaw length		Reading		Stepped jaws mm	Ref. No.	List price Euro
			mm	inch	mm	inch	mm	inch			
<b>Without fine adjustment</b>											
			300	12	90	3.5	0.01	.0005	10	1351 522	512.00
			500	20	125	5.0	0.01	.0005	20	1351 528	662.00

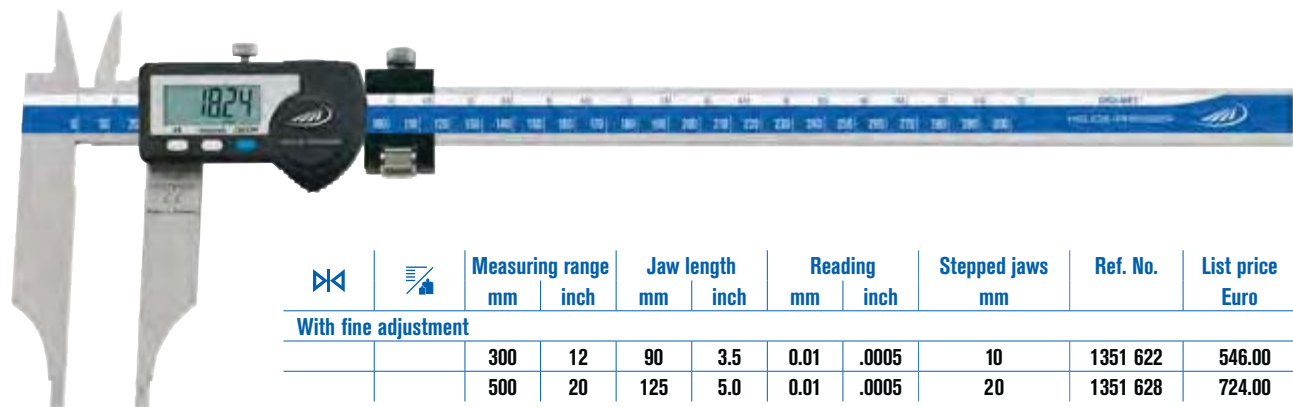

	⏏	📏	Measuring range		Jaw length		Reading		Stepped jaws mm	Ref. No.	List price Euro
			mm	inch	mm	inch	mm	inch			
<b>With fine adjustment</b>											
			300	12	90	3.5	0.01	.0005	10	1351 622	546.00
			500	20	125	5.0	0.01	.0005	20	1351 628	724.00

### Accessories

	Ref. No.	List price Euro
Battery, 3V-Lithium, CR 2032	0220 704	3.60
Cable for USB, incl. software	1998 720	66.00
Cable for RS 232	1997 501	46.20
Cable for Digimatic	1998 501	59.00

Jean Louis MENEGON - Votre représentant et Conseiller- Tél. : 06 76 08 96 83

E-mail: [jlouismenegon@aol.com](mailto:jlouismenegon@aol.com) - web: [www.menegon-metrologie.com](http://www.menegon-metrologie.com)



# HELIOS • PREISSER

## 1338 DIGI-MET® Workshop caliper PRISMA



### Specification

- Double prisma guide with excellent sliding characteristics
- Stainless steel
- Accuracy in accordance to DIN 862
- LCD display 8.5 mm
- Locking screw
- Knife points
- Stepped jaws for inside measurement 10 mm

### Electronic functions

- ON/OFF switch
- **QuickStart** Electronic
- **QuickLock** Function
- Zero setting at any position
- mm/inch conversion
- Variable data output RS232 + Digimatic + USB
- **PRESET** Function (setting a numerical value)

### Shipment

- Wooden case



1

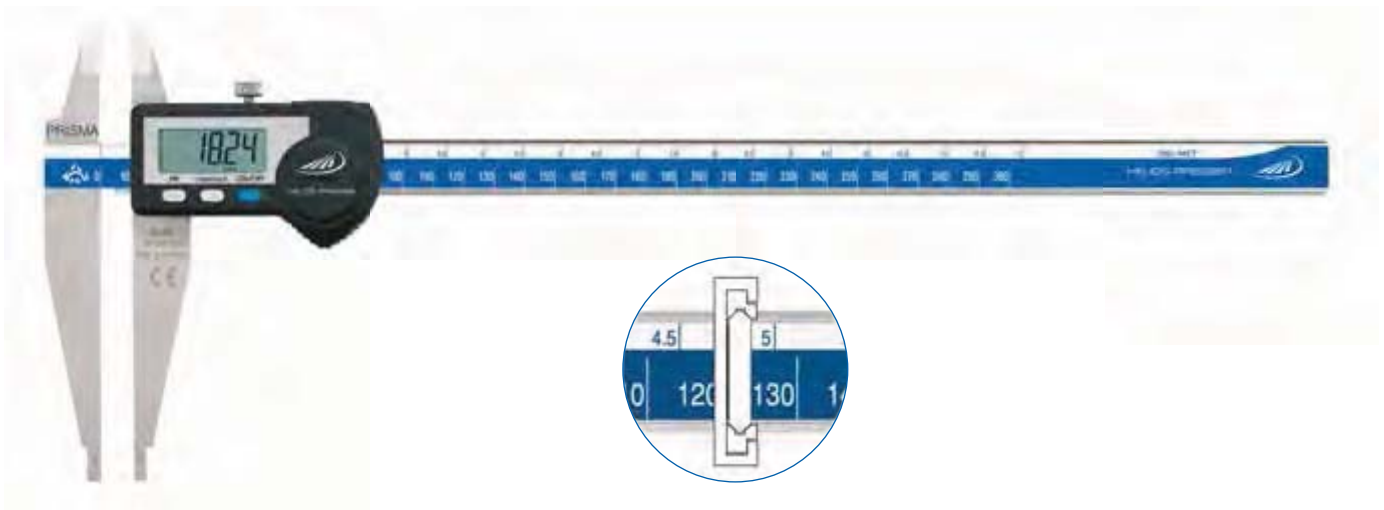

		Measuring range		Jaw length		Reading		Ref. No.	List price Euro
		mm	inch	mm	inch	mm	inch		
▪		300	12	90	3.5	0.01	.0005	1338 522	439.00

Accessories	Ref. No.	List price Euro
Battery, 3V-Lithium, CR 2032	0220 704	3.60
Cable for USB, incl. software	1998 720	66.00
Cable for RS 232	1997 501	46.20
Cable for Digimatic	1998 501	59.00

Jean Louis MENEGON - Votre représentant et Conseiller- Tél. : 06 76 08 96 83  
 E-mail: [jlouismenegon@aol.com](mailto:jlouismenegon@aol.com) - web: [www.menegon-metrologie.com](http://www.menegon-metrologie.com)



0228 DIGI-MET® Workshop calipers lightweight



0228 702

Specification

- To reduce weight, both the slide and beam are made of aluminium, with a hard anodized surface coating (1100 HV)
- Measuring faces are made of hardened stainless steel
- Factory standard
- Smoother, more even movement due to the double V-guide
- LCD display
- Locking screw
- Knife points

Electronic functions

- ON/OFF switch
- Zero setting at any position
- mm/inch conversion
- PRESET Function (setting a numerical value)

Shipment

- Wooden case

⊗	⚡	Measuring range		Jaw length		Reading		Ref. No.	List price Euro
		mm	inch	mm	inch	mm	inch		
		300	12	90	3.5	0.01	.0005	0228 701*	455.00
		500	20	150	6.0	0.01	.0005	0228 702	633.00
		800	31	150	6.0	0.01	.0005	0228 703	890.00
		1000	39	150	6.0	0.01	.0005	0228 704	1,050.00
	▪	1500	59	200	8.0	0.01	.0005	0228 724	2,650.00
	▪	2000	79	200	8.0	0.01	.0005	0228 726	3,150.00

\* With data output Opto RS232

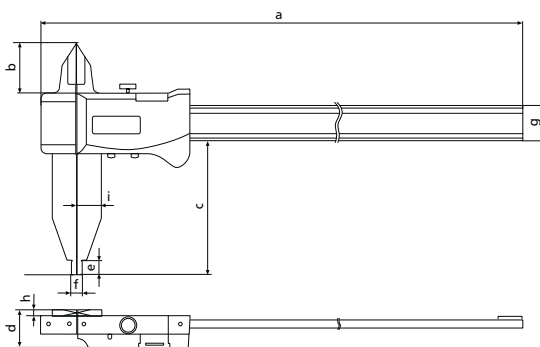

Dimensions	a	b	c	d	e	f	g	h	i
300	450	33	90	24.5	10	10	25.0	4.5	17.0
500	726	42	150	33.5	15	20	31.9	6.0	29.0
800	1026	42	150	33.5	15	20	31.9	6.0	29.0
1000	1226	42	150	33.5	15	20	31.9	6.0	29.0
1500	1526	42	200	33.5	15	20	31.9	6.0	29.0
2000	2026	42	200	33.5	15	20	31.9	6.0	29.0

Accessories

	Ref. No.	List price Euro
Battery, 3V-Lithium, CR 2032	0220 704	3.60

Jean Louis MENEGON - Votre représentant et Conseiller- Tél. : 06 76 08 96 83

E-mail: [jlouismenegon@aol.com](mailto:jlouismenegon@aol.com) - web: [www.menegon-metrologie.com](http://www.menegon-metrologie.com)



1351 DIGI-MET® Caliper with cross points

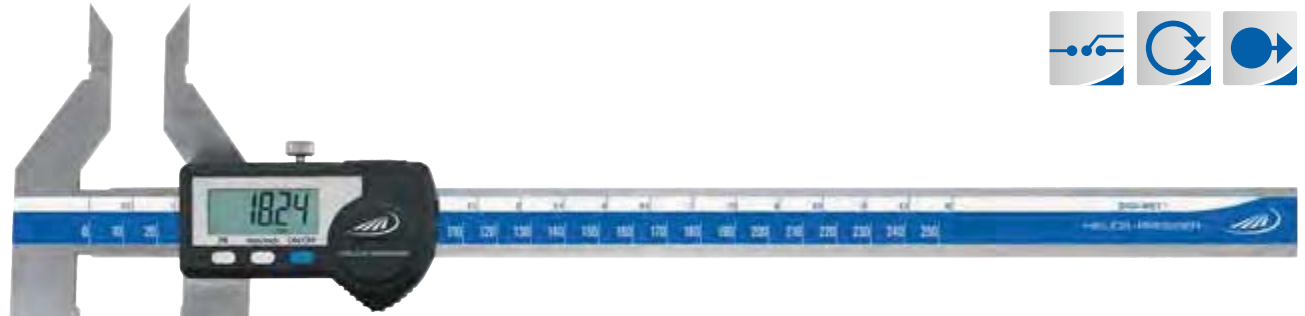

1

**Specification**

- Stainless steel
- LCD display 8.5 mm
- Factory standard
- Locking screw
- Inside cross points

**Electronic functions**

- ON/OFF switch
- **QuickStart** Electronic
- **QuickLock** Function
- Zero-setting at any position
- mm/inch-conversion
- Variable data output RS 232 + Digimatic + USB
- PRESET Function (setting a numerical value)

**Shipment**

- Wooden case

✂	☑	Measuring range		Length of cross points		Jaw length		Reading		Ref. No.	List price Euro
		mm	inch	mm	inch	mm	inch	mm	inch		
		250	10	55	2.17	80	3.15	0.01	0.005	1351 920	461.00

1354 DIGI-MET® Caliper with gripper points



Jean Louis MENEGON - Votre représentant et Conseiller- Tél. : 06 76 08 96 83  
E-mail: [jlouismenegon@aol.com](mailto:jlouismenegon@aol.com) - web: [www.menegon-metrologie.com](http://www.menegon-metrologie.com)

**Specification**

- Stainless steel
- LCD display 8.5 mm
- Factory standard
- Locking screw
- Gripper points

**Electronic functions**

- ON/OFF switch
- **QuickStart** Electronic
- **QuickLock** Function
- Zero setting at any position
- mm/inch conversion
- Variable data output RS 232 + Digimatic + USB
- PRESET Function (setting a numerical value)

**Shipment**

- Wooden case

✂	☑	Measuring range		Length of gripper points		Jaw length		Reading		Ref. No.	List price Euro
		mm	inch	mm	inch	mm	inch	mm	inch		
		250	10	55	2.17	75	3.00	0.01	0.005	1354 520	545.00





# 1348 DIGI-MET® Universal calipers

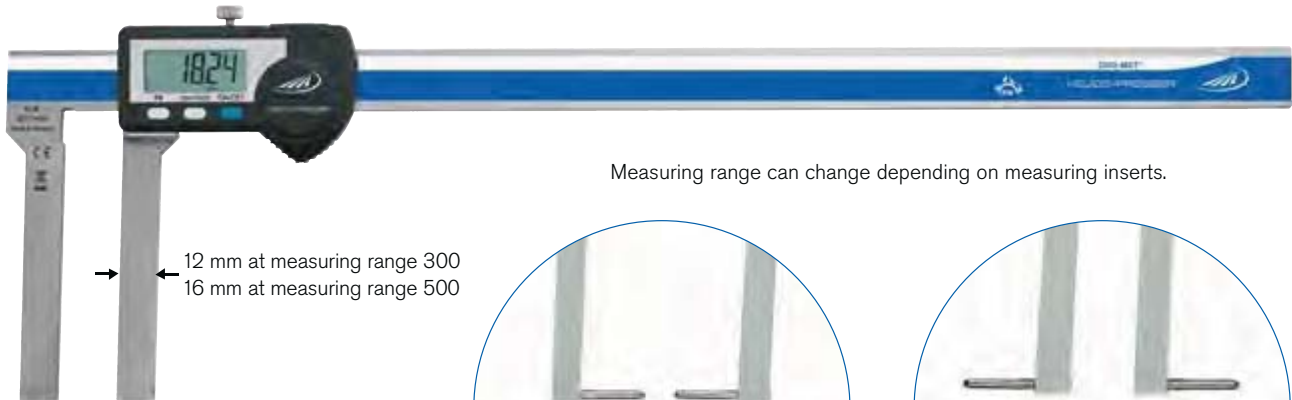

Measuring range can change depending on measuring inserts.

→ ← 12 mm at measuring range 300  
16 mm at measuring range 500

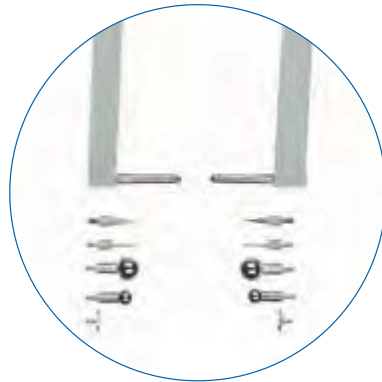

▪ for external measurements

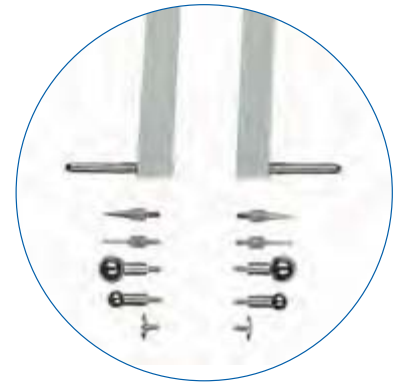

▪ for internal measurements

### Specification

- Stainless steel
- Factory standard
- LCD display 8.5 or 12.5 mm
- Locking screw
- For internal and external measurements
- Individually adaptable on

problematic measuring tasks through measuring inserts with thread M 2.5 (optional see pages 132 - 134)

### Electronic functions

- ON/OFF switch
- **QuickStart** Electronic
- **QuickLock** Function
- Zero setting at any position
- mm/inch conversion
- Variable data output RS 232 + Digimatic + USB
- PRESET Function (setting a numerical value)

### Shipment

- Wooden case
- Without measuring inserts (correct measuring inserts with thread M 2.5 see pages 132 - 134)

⌂	🏠	Measuring range		Jaw length		Reading		Ref. No.	List price Euro
		mm	inch	mm	inch	mm	inch		
		300	12	90	3.5	0.01	.0005	1348 722	561.00
		500	20	100	4.0	0.01	.0005	1348 728	719.00

Accessories	Ref. No.	List price Euro
Battery, 3V-Lithium, CR 2032	0220 704	3.60
Cable for USB, incl. software	1998 720	66.00
Cable for RS 232	1997 501	46.20
Cable for Digimatic	1998 501	59.00

Jean Louis MENEGON - Votre représentant et Conseiller- Tél. : 06 76 08 96 83

E-mail: [jlouismenegon@aol.com](mailto:jlouismenegon@aol.com) - web: [www.menegon-metrologie.com](http://www.menegon-metrologie.com)



## 1326 Universal pocket caliper "Pocket Talent"



1

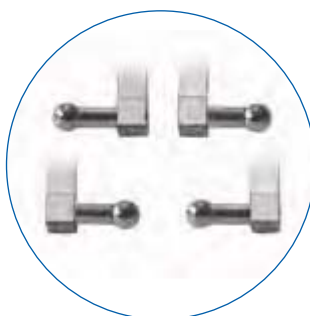

0710177

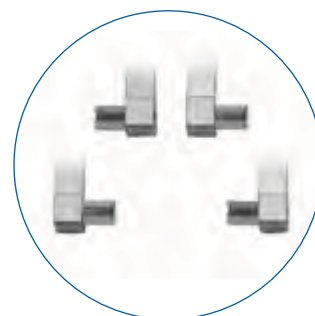

0710161

### See No. 1326 932 on page 29



## 0250 Contraction vernier calipers

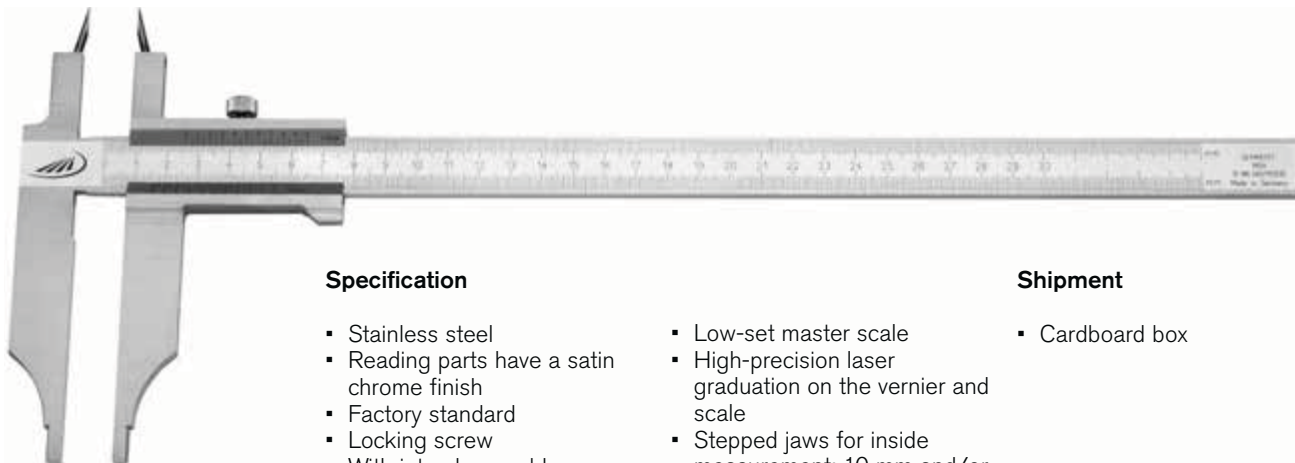

### Specification

- Stainless steel
- Reading parts have a satin chrome finish
- Factory standard
- Locking screw
- With interchangeable hardened scribing jaws
- Low-set master scale
- High-precision laser graduation on the vernier and scale
- Stepped jaws for inside measurement: 10 mm and/or 20 mm\*

### Shipment

- Cardboard box

Icon 1	Icon 2	Measuring range mm	Jaw length mm	Reading		Ref. No.	List price Euro
				mm	mm		
<b>Direct reading for internal and external measurement</b>							
		300	90	0.05	0.05	0250 501	236.00
		500	150	0.05	0.05	0250 502*	642.00
		600	150	0.05	0.05	0250 503*	761.00
		800	150	0.05	0.05	0250 504*	961.00
		1000	150	0.05	0.05	0250 505*	1,167.00
<b>Contraction scale divisions 1.0% ▪ 1.5% ▪ 2.0% ▪ 1/1 mm</b>							
		300	90	0.1		0250 511	254.00
		500	150	0.1		0250 512*	674.00
		600	150	0.1		0250 513*	801.00
		800	150	0.1		0250 514*	1,030.00
		1000	150	0.1		0250 515*	1,251.00
<b>Contraction scale divisions 0.5% ▪ 0.8% ▪ 1.0% ▪ 1/1 mm</b>							
		300	90	0.1		0250 521	254.00
		500	150	0.1		0250 522*	674.00
		600	150	0.1		0250 523*	801.00
		800	150	0.1		0250 524*	1,030.00
		1000	150	0.1		0250 525*	1,251.00
<b>Contraction scale divisions 1.0% ▪ 1.25% ▪ 1.5% ▪ 1/1 mm</b>							
		300	90	0.1		0250 531	254.00
		500	150	0.1		0250 532*	674.00
		600	150	0.1		0250 533*	801.00
		800	150	0.1		0250 534*	1,030.00
		1000	150	0.1		0250 535*	1,251.00
<b>Contraction scale divisions 1.75% ▪ 2.0% ▪ 2.5% ▪ 1/1 mm</b>							
		300	90	0.1		0250 541	254.00
		500	150	0.1		0250 542*	674.00
		600	150	0.1		0250 543*	801.00
		800	150	0.1		0250 544*	1,030.00
		1000	150	0.1		0250 545*	1,251.00

Jean Louis MENEGON - Votre représentant et Conseiller- Tél. : 06 76 08 96 83

E-mail: [jlouismenegon@aol.com](mailto:jlouismenegon@aol.com) - web: [www.menegon-metrologie.com](http://www.menegon-metrologie.com)



## 0250 Contraction vernier calipers



		Measuring range mm	Jaw length mm	Reading		Ref. No.	List price Euro
				mm	mm		
<b>Contraction scale divisions 1.0% ▪ 1.25% ▪ 2.0% ▪ 1/1 mm</b>							
		300	90	0.1		0250 551	254.00
		500	150	0.1		0250 552*	674.00
		600	150	0.1		0250 553*	801.00
		800	150	0.1		0250 554*	1,030.00
		1000	150	0.1		0250 555*	1,251.00
<b>Contraction scale divisions 0.3% ▪ 0.4% ▪ 0.6% ▪ 1/1 mm</b>							
		300	90	0.1		0250 561	254.00
		500	150	0.1		0250 562*	674.00
		600	150	0.1		0250 563*	801.00
		800	150	0.1		0250 564*	1,030.00
		1000	150	0.1		0250 565*	1,251.00
<b>Contraction scale divisions 1.0% ▪ 1.25% ▪ 1.5% ▪ 2.0%</b>							
		300	90	0.1		0250 571	267.00
		500	150	0.1		0250 572*	743.00
		600	150	0.1		0250 573*	884.00
		800	150	0.1		0250 574*	1,112.00
		1000	150	0.1		0250 575*	1,350.00

## Interchangeable points (pair) for contraction vernier calipers



## Specification

- dia. 3.0 mm and/or
- dia. 4.0 mm\*

		For measuring range	Material	Ref. No.	List price
					Euro
		300 mm	Steel, hardened	0250 101	5.50
		500 + 600 mm	Steel, hardened	0250 102	11.00
		800 + 1000 mm	Steel, hardened	0250 103*	15.00
		300 mm	Carbide	0250 201	55.00
		500 + 600 mm	Carbide	0250 202	79.00



## 0262 Caliper for external locking grooves



**Jean Louis MENEGON** - Votre représentant et Conseiller- Tél. : **06 76 08 96 83**  
E-mail: [jlouismenegon@aol.com](mailto:jlouismenegon@aol.com) - web: [www.menegon-metrologie.com](http://www.menegon-metrologie.com)

### Specification

- Stainless steel
- Reading parts have a satin chrome finish
- Factory standard
- Locking screw
- Low-set master scale
- High-precision laser graduation on the vernier and scale

### Shipment

- Cardboard box

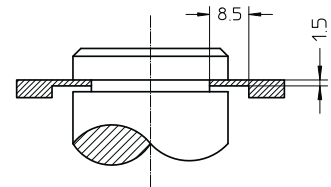

✂	📏	Measuring range		Jaw length		Reading		Ref. No.	List price Euro
		mm	inch	mm	inch	mm	inch		
		300	12	90	3.5	0.05	1/128	0262 503	250.00

## 1353 DIGI-MET® Caliper for external locking grooves

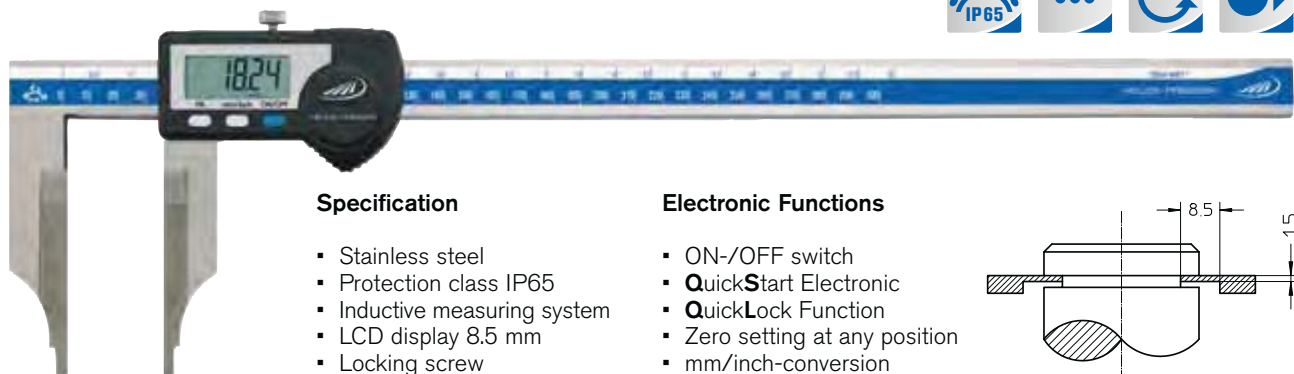

### Specification

- Stainless steel
- Protection class IP65
- Inductive measuring system
- LCD display 8.5 mm
- Locking screw
- Factory Standard

### Electronic Functions

- ON-/OFF switch
- **QuickStart** Electronic
- **QuickLock** Function
- Zero setting at any position
- mm/inch-conversion
- Variable data output RS 232 + Digimatic + USB
- PRESET Function (setting a numerical value)

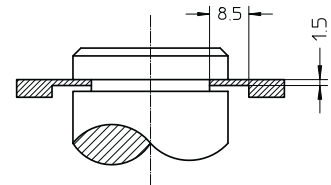

### Shipment

- Wooden case

✂	📏	Measuring range		Jaw length		Reading		Ref. No.	List price Euro
		mm	inch	mm	inch	mm	inch		
		300	12	90	3.5	0.01	.0005	1353 522	453.00

### Accessories

	Ref. No.	List price Euro
Battery, 3V-Lithium, CR 2032	0220 704	3.60
Cable for USB, incl. software	1998 720	66.00
Cable for RS 232	1997 501	46.20
Cable for Digimatic	1998 501	59.00



# HELIOS • PREISSER

## 0252 Brake drum vernier calipers

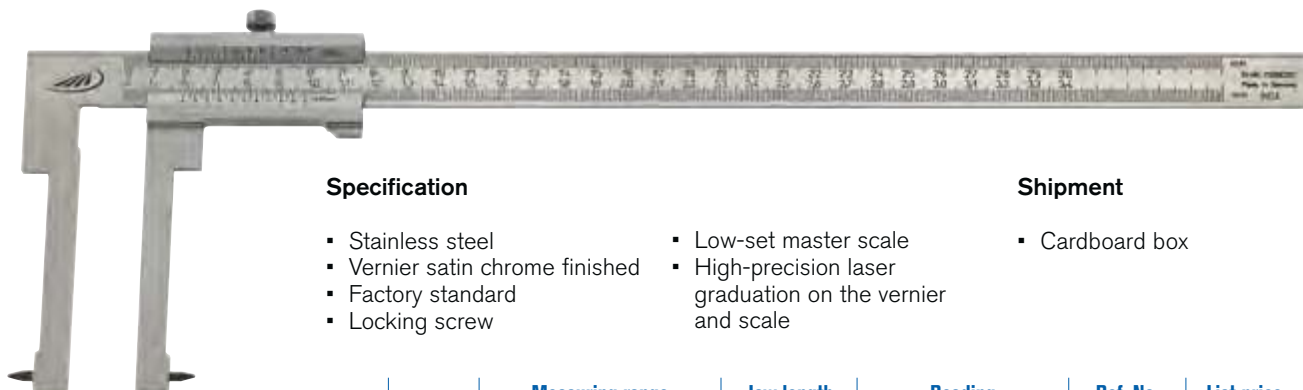

### Specification

- Stainless steel
- Vernier satin chrome finished
- Factory standard
- Locking screw
- Low-set master scale
- High-precision laser graduation on the vernier and scale

### Shipment

- Cardboard box

☒	☒	Measuring range		Jaw length mm	Reading		Ref. No.	List price Euro
		Internal mm	External mm		mm	mm		
		40 - 300	0 - 300	90	0.05	0.05	0252 201	132.00
		50 - 500	0 - 500	150	0.05	0.05	0252 202	254.00
		50 - 600	0 - 600	200	0.05	0.05	0252 203	278.00

## Replacement points (pair) for brake drum vernier caliper

☒	☒	For measuring range	Ref. No.	List price Euro
		300 mm	0252 291	4.00
		500 + 600 mm	0252 293	5.00

## 0253 Brake disc inspection gauges



0253 301

### Specification

- Special steel
- Reading parts have a satin chrome finish
- Factory standard
- Locking screw
- With trailing vernier
- High-precision laser graduation on the vernier and scale

### Shipment

- Cardboard box

☒	☒	Measuring range mm	Jaw length mm	Reading mm	Ref. No.	List price Euro
<b>For motorcycles</b>						
		0 - 50	30	0.1	0253 300	78.00
<b>For cars</b>						
		0 - 50	50	0.1	0253 301	78.00
<b>For buses</b>						
		0 - 80	50	0.1	0253 302	99.00

## Replacement points (pair) for brake disc inspection gauge

Jean Louis MENEGON - Votre représentant et Conseiller- Tél. : 06 76 08 96 83  
E-mail: [jlouismenegon@aol.com](mailto:jlouismenegon@aol.com) - web: [www.menegon-metrologie.com](http://www.menegon-metrologie.com)

☒	☒	Ref. No.	List price Euro
		0253 391	3.60



## 0258 Calipers for internal grooves



### Specification

- Stainless steel
- Reading parts have a satin chrome finish
- Factory standard
- Locking screw
- Low-set master scale
- High-precision laser graduation on the vernier and scale

### Shipment

- Cardboard box

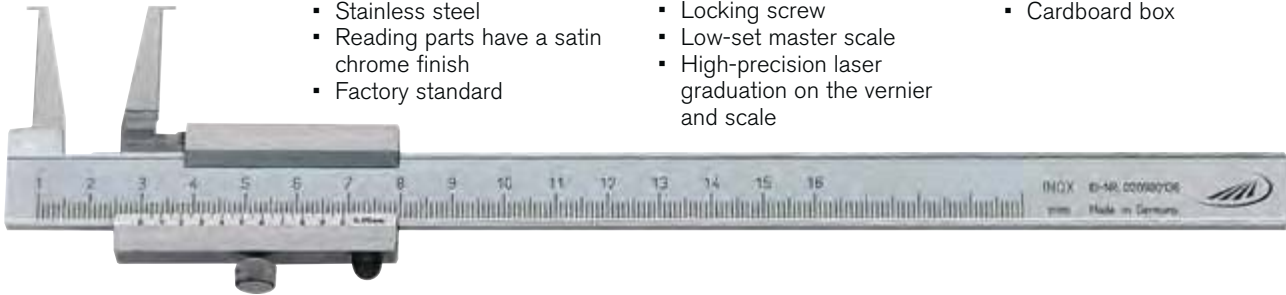

		Measuring range mm	Jaw length mm	Reading mm	Ref. No.	List price Euro
✂	📏	10 - 160	25	0.05	0258 501	133.00
		20 - 160	40	0.05	0258 502	177.00
		26 - 200	60	0.05	0258 503	272.00
		30 - 250	80	0.05	0258 504	308.00
		35 - 300	100	0.05	0258 505	344.00

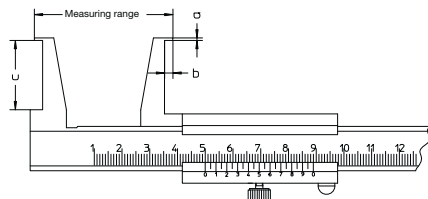

Dimensions for the digital version are identical

Measuring range mm	Jaw dimensions mm	
	a	b
10 - 160	0.9	3.0
20 - 160	2.0	5.0
26 - 200	3.0	7.0
30 - 250	4.0	8.5
35 - 300	5.0	10.0

## 1352 DIGI-MET® Calipers for internal grooves



### Specification

- Stainless steel
- LCD display 7.5 mm
- Factory standard
- Locking screw

### Electronic functions

- ON/OFF switch
- QuickStart Electronic
- QuickLock Function
- Zero setting at any position
- mm/inch conversion
- Variable data output  
RS 232 + Digimatic + USB
- PRESET Function  
(setting a numerical value)

### Shipment

- Wooden case



Jean Louis MENEGON - Votre représentant et Conseiller- Tél. : 06 76 08 96 83

E-mail: [jlouismenegon@aol.com](mailto:jlouismenegon@aol.com) - web: [www.menegon-metrologie.com](http://www.menegon-metrologie.com)

		Measuring range mm	Jaw length		Reading		Ref. No.	List price Euro
			mm	inch	mm	inch		
✂	📏	10 - 160	25	1.0	0.01	.0005	1352 516	358.00
		20 - 160	40	1.5	0.01	.0005	1352 517	403.00
		26 - 200	60	2.3	0.01	.0005	1352 518	739.00
		30 - 250	80	3.1	0.01	.0005	1352 520	832.00
		35 - 300	100	3.9	0.01	.0005	1352 522	867.00



# HELIOS • PREISSER

## 0260 Calipers for 3/5 point measurement

### Specification

- Stainless steel
- Reading parts have a satin chrome finish
- Factory standard
- Locking screw

### Shipment

- Cardboard box

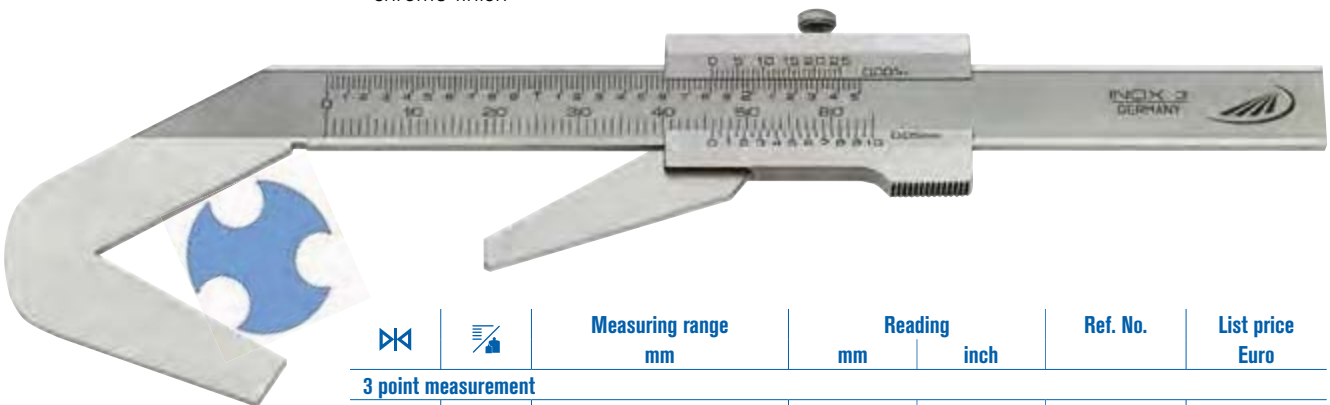

		Measuring range mm	Reading		Ref. No.	List price Euro
			mm	inch		
<b>3 point measurement</b>						
		4 - 40	0.05	0.001	0260 501	68.00
<b>5 point measurement</b>						
		2 - 40	0.05	0.001	0260 502	68.00

## 0268 Milling tool caliper

### Specification

- Stainless steel
- Vernier satin chrome finished
- Factory standard

### Application

- Setting of milling cutters, can be used as height gauge

### Shipment

- Cardboard box

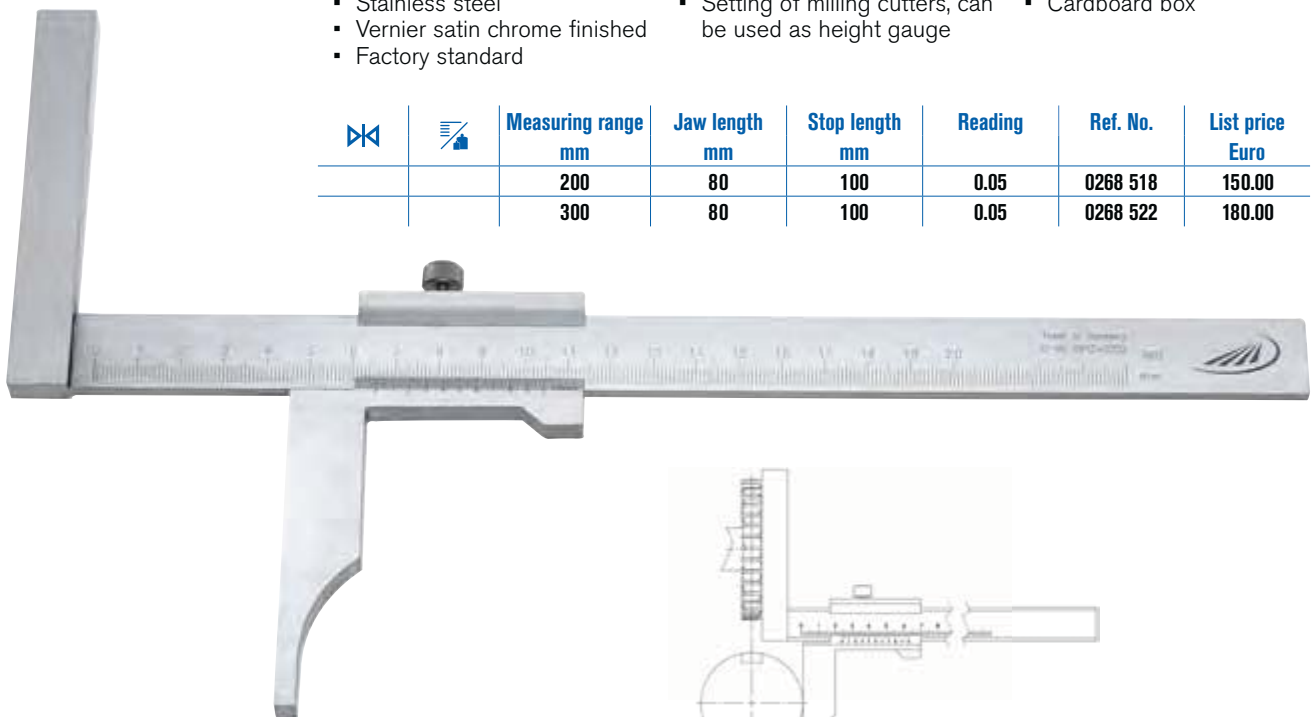

		Measuring range mm	Jaw length mm	Stop length mm	Reading	Ref. No.	List price Euro
		300	80	100	0.05	0268 522	180.00

Jean Louis MENEGON - Votre représentant et Conseiller- Tél. : 06 76 08 96 83

E-mail: [jlouismenegon@aol.com](mailto:jlouismenegon@aol.com) - web: [www.menegon-metrologie.com](http://www.menegon-metrologie.com)





## 0597 Chamfer gauge



### Specification

- Factory standard
- For simultaneously testing of the chamfer angle and the dimensional accuracy
- Stainless steel
- Reading 0.1 mm
- Reading parts are satin chrome finished

- Dimensions: 48x30x8.5 mm

### Shipment

- Wooden case
- 3 interchangeable blades: 30°, 45°, 60°

		Measuring range mm	Reading mm	Ref. No.	List price Euro
		10	0.1	0597 301	162.00

## 0597 Radius gauge



### Specification

- To determine radii size workpieces
- Stainless steel
- Reading parts are satin chrome finished

### Shipment

- Wooden case

		Measuring range mm	Reading mm	Ref. No.	List price Euro
		10	0.1	0597 305	162.00



0268 Gear tooth calipers

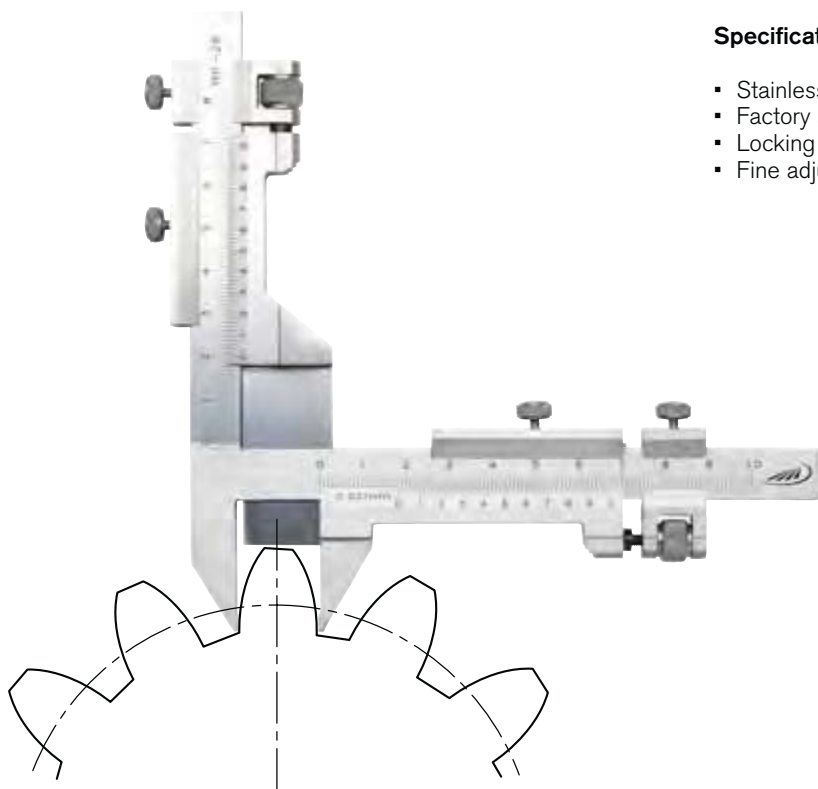



Specification

- Stainless steel
- Factory standard
- Locking screw
- Fine adjustment

Shipment

- Wooden case

1

		Module mm	Reading mm	Ref. No.	List price Euro
<b>Hardened jaw tips</b>					
		1 - 26	0.02	0268 201	285.00
<b>Carbide tipped jaw tips</b>					
		1 - 26	0.02	0268 211	347.00

Jean Louis MENEGON - Votre représentant et Conseiller- Tél. : 06 76 08 96 83

E-mail: [jlouismenegon@aol.com](mailto:jlouismenegon@aol.com) - web: [www.menegon-metrologie.com](http://www.menegon-metrologie.com)



## 0280 / 0281 Vernier depth gauges



### Specification

- Stainless steel
- Reading parts have a satin chrome finish
- DIN 862
- Low-set master scale
- Locking screw
- Measuring rod with interchangeable pin
- High-precision laser graduation on the vernier and scale

### Shipment

- Cardboard box

**DIN  
862**

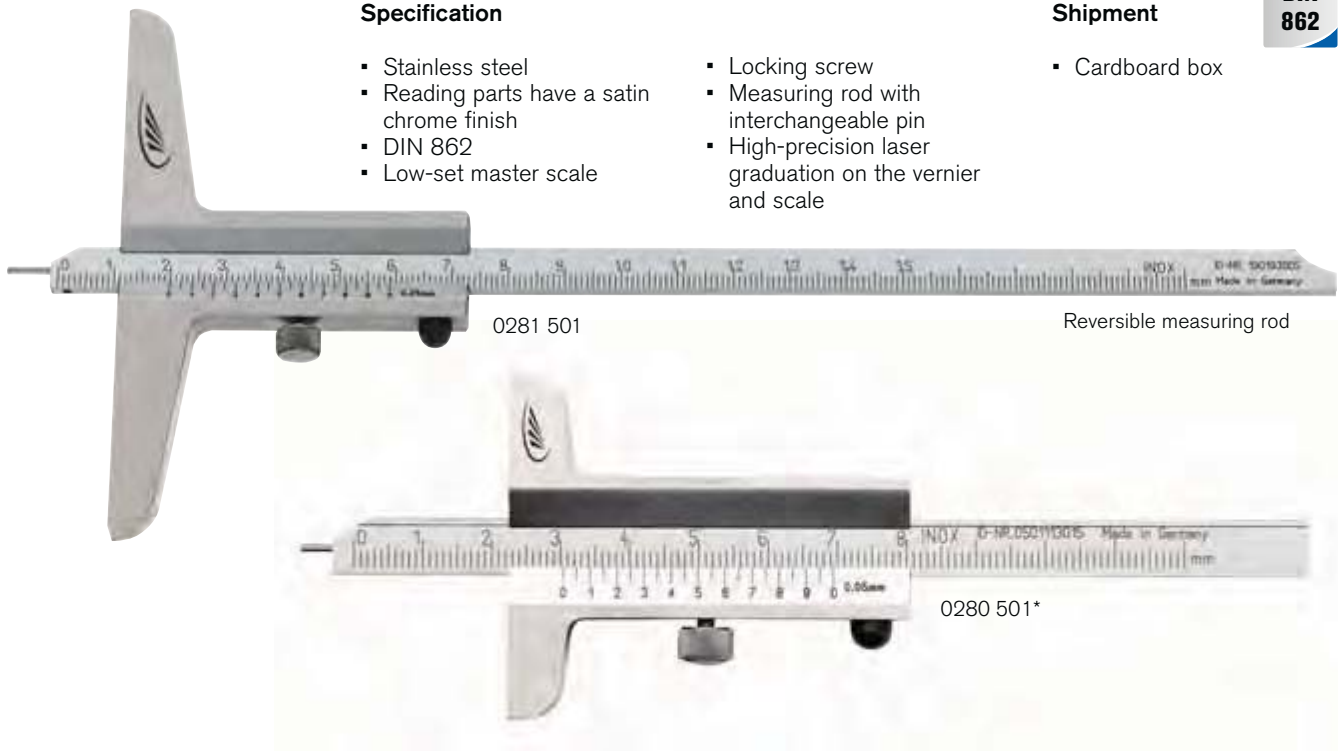

Icon	Icon	Measuring range		Base length		Reading	Ref. No.	List price
		mm	inch	mm	inch			
<b>Vernier satin chrome finished, measuring rod with interchangeable pin</b>								
▪		80		50	2	0.05	0280 501*	49.00
<b>Vernier satin chrome finished, reversible measuring rod with interchangeable pin</b>								
▪		150	6	100	4	0.05	0281 201	75.00
▪		200	8	100	4	0.05	0281 202	78.00
▪		250	10	130	5	0.05	0281 204	87.00
▪		300	12	150	6	0.05	0281 205	98.00
<b>Vernier + scale satin chrome finished, reversible measuring rod with interchangeable pin</b>								
▪		150	6	100	4	0.05	0281 501	82.00
▪		200	8	100	4	0.05	0281 502	85.00
▪		250	10	130	5	0.05	0281 504	97.00
▪		300	12	150	6	0.05	0281 505	106.00

\* Factory standard

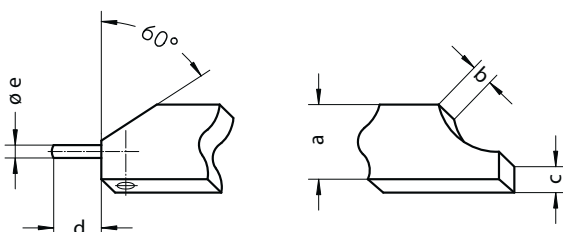

Meas. range mm	a	b	c	d	e
80	8	3	-	6	1
150 - 200	8	3	3.5	8	1.5
250 - 300	12	4	4	8	2

**Jean Louis MENEGON** - Votre représentant et Conseiller- Tél. : 06 76 08 96 83

E-mail: [jlouismenegon@aol.com](mailto:jlouismenegon@aol.com) - web: [www.menegon-metrologie.com](http://www.menegon-metrologie.com)



## 0282 Vernier depth gauges



**DIN  
862**

### Specification

- DIN 862
- Locking screw
- Straight measuring rod
- Low-set master scale
- High-precision laser graduation on the vernier and scale

### Shipment

- Cardboard box for calipers up to 1000 mm, larger measuring ranges are individually packed



**Jean Louis MENEGON** - Votre représentant et Conseiller- Tél. : 06 76 08 96 83  
E-mail: [jlouismenegon@aol.com](mailto:jlouismenegon@aol.com) - web: [www.menegon-metrologie.com](http://www.menegon-metrologie.com)

⊗	☒	Measuring range		Base length		Reading mm	Ref. No.	List price Euro
		mm	inch	mm	inch			
<b>Stainless steel, vernier satin chrome finished</b>								
▪		150	6	100	4	0.05	0282 201	66.00
▪		200	8	100	4	0.05	0282 202	68.00
▪		300	12	100	4	0.05	0282 203	79.00
▪		250	10	130	5	0.05	0282 204	76.00
▪		300	12	150	6	0.05	0282 205	83.00
▪		400	16	150	6	0.05	0282 206	93.00
▪		500	20	150	6	0.05	0282 207	128.00
▪		500	20	250	10	0.05	0282 208	197.00
▪		800	31	250	10	0.05	0282 209	325.00
▪		1000	39	250	10	0.05	0282 210	462.00
	▪	1500	59	300	12	0.05	0282 212	1,128.00
	▪	2000	79	300	12	0.05	0282 213	1,482.00
<b>Stainless steel, vernier + scale satin chrome finished</b>								
▪		150	6	100	4	0.05	0282 501	72.00
▪		200	8	100	4	0.05	0282 502	76.00
▪		300	12	100	4	0.05	0282 503	86.00
▪		250	10	130	5	0.05	0282 504	83.00
▪		300	12	150	6	0.05	0282 505	91.00
▪		500	20	150	6	0.05	0282 507	141.00
▪		500	20	250	10	0.05	0282 508	215.00
▪		800	31	250	10	0.05	0282 509	357.00
▪		1000	39	250	10	0.05	0282 510	506.00

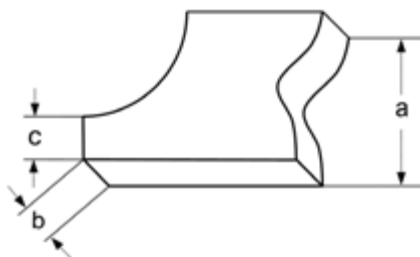

Measuring range mm	Dimension mm		
	a	b	c
150 - 200	8.0	3.0	3.5
250 - 500	12.0	4.0	4.0
500 - 1000	20.0	5.0	10.0
1500	25.0	6.0	13.0
2000	30.0	7.0	13.0



## 0286 Vernier depth gauges



### Specification

- DIN 862
- Locking screw
- Reversible, L shaped measuring rod
- Scales on both sides
- Low-set master scale
- High-precision laser graduation on the vernier and scale

### Shipment

- Cardboard box for calipers up to 1000 mm, larger measuring ranges are individually packed

**DIN  
862**



Reversible measuring rod

**Jean Louis MENEGON** - Votre représentant et Conseiller- Tél. : 06 76 08 96 83  
E-mail: [jlouismenegon@aol.com](mailto:jlouismenegon@aol.com) - web: [www.menegon-metrologie.com](http://www.menegon-metrologie.com)

✂	🏠	Measuring range		Base length		Reading mm	Ref. No.	List price Euro
		mm	inch	mm	inch			
<b>Stainless steel, vernier satin chrome finished</b>								
▪		150	6	100	4	0.05	0286 201	79.00
▪		200	8	100	4	0.05	0286 202	81.00
▪		250	10	130	5	0.05	0286 204	91.00
▪		300	12	150	6	0.05	0286 205	98.00
▪		400	16	150	6	0.05	0286 206	121.00
▪		500	20	150	6	0.05	0286 207	154.00
▪		500	20	250	10	0.05	0286 208	258.00
▪		800	31	250	10	0.05	0286 209	404.00
▪		1000	39	250	10	0.05	0286 210	561.00
	▪	1500	59	300	12	0.05	0286 212	1,212.00
	▪	2000	79	300	12	0.05	0286 213	1,562.00
<b>Stainless steel, vernier + scale satin chrome finished</b>								
▪		150	6	100	4	0.05	0286 501	86.00
▪		200	8	100	4	0.05	0286 502	87.00
▪		250	10	130	5	0.05	0286 504	100.00
▪		300	12	150	6	0.05	0286 505	106.00
▪		500	20	150	6	0.05	0286 507	170.00
▪		500	20	250	10	0.05	0286 508	358.00
▪		800	31	250	10	0.05	0286 509	483.00
▪		1000	39	250	10	0.05	0286 510	615.00

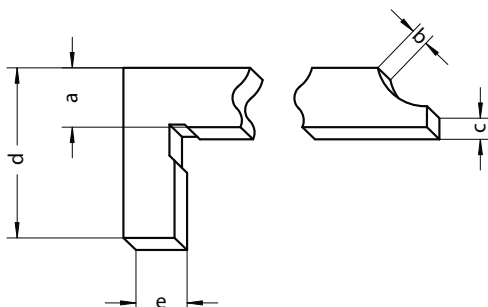

Meas. range mm	a	b	c	d	e
150 - 200	8	3	3.5	20	5
250 - 500	12	4	4	28	10
500 - 1000	20	5	10	70	19
1500	25	6	10	90	24
2000	30	7	10	90	29



# HELIOS • PREISSER

## 0292 Offset vernier depth gauges

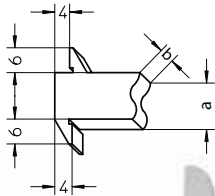

### Specification

- Stainless steel
- Reading parts have a satin chrome finish
- Factory standard
- Locking screw
- Reversible, offset meas. rod
- Low-set master scale
- Scales on both sides
- High-precision laser graduation on the vernier and scale

### Shipment

- Cardboard box

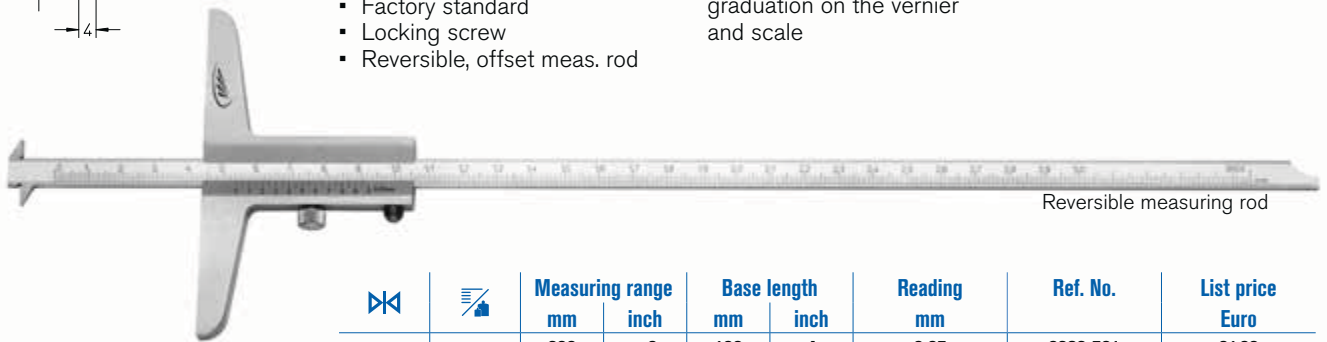

Reversible measuring rod

QuickLock	QuickStart	Measuring range		Base length		Reading mm	Ref. No.	List price Euro
		mm	inch	mm	inch			
		200	8	100	4	0,05	0292 501	81.00
		300	12	100	4	0,05	0292 502	92.00

## 0294 Vernier depth gauges with sliding measuring base



### Specification

- Stainless steel
- Reading parts have a satin chrome finish
- Factory standard
- Locking screw
- Sliding measuring base
- With measuring plate and pin for width and distance measurements
- Low-set master scale
- Scales on both sides
- High-precision laser graduation on the vernier and scale

### Shipment

- Wooden case

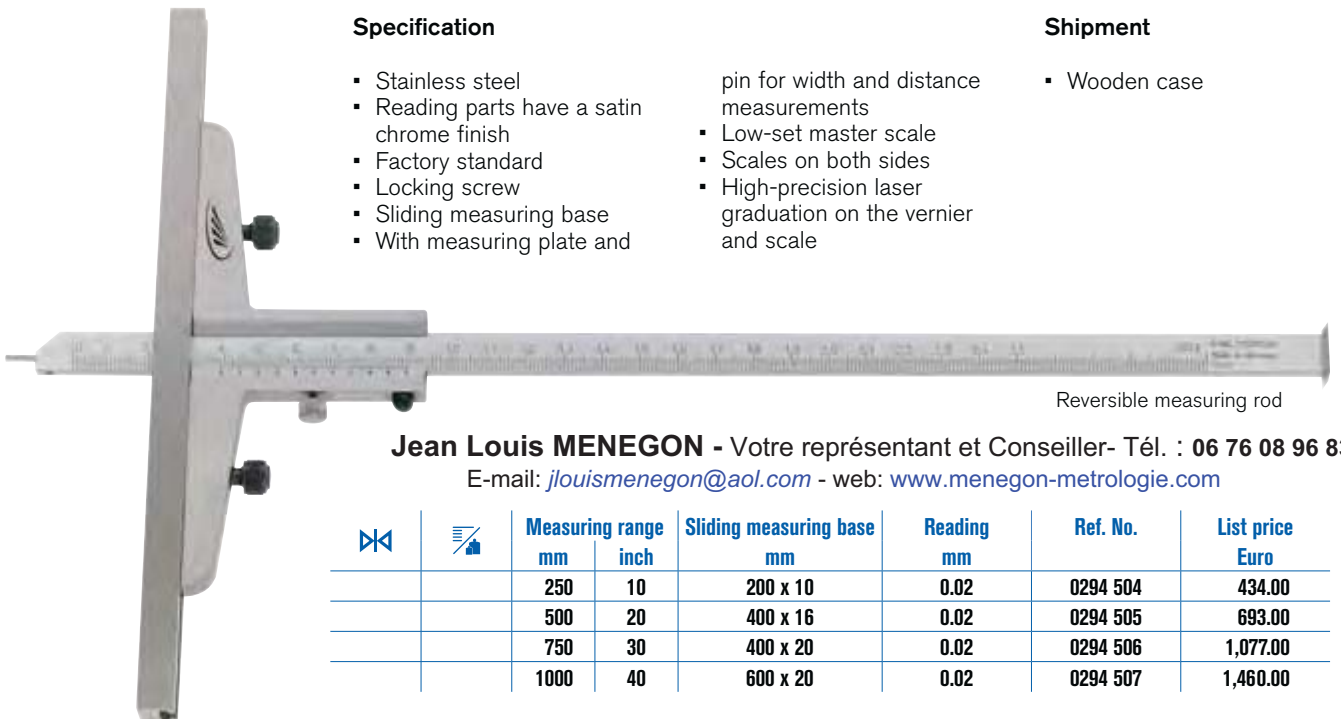

Reversible measuring rod

Jean Louis MENEGON - Votre représentant et Conseiller- Tél. : 06 76 08 96 83

E-mail: [jlouismenegon@aol.com](mailto:jlouismenegon@aol.com) - web: [www.menegon-metrologie.com](http://www.menegon-metrologie.com)

QuickLock	QuickStart	Measuring range		Sliding measuring base mm	Reading mm	Ref. No.	List price Euro
		mm	inch				
		250	10	200 x 10	0.02	0294 504	434.00
		500	20	400 x 16	0.02	0294 505	693.00
		750	30	400 x 20	0.02	0294 506	1,077.00
		1000	40	600 x 20	0.02	0294 507	1,460.00

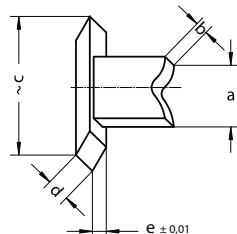
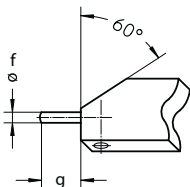

Meas. range mm	a	b	c	d	e	f	g
250 - 500	12	4	18	6	2	2	8
750 - 1000	20	5	30	8	3	3	8



## 1360 DIGI-MET® Depth gauges



### Specification

- Stainless steel
- Protection class IP67
- LCD display 7.5 mm
- DIN 862
- Locking screw
- Straight measuring rod

### Electronic functions

- ON/OFF switch
- **QuickStart** Electronic
- **QuickLock** Function
- Zero setting at any position
- mm/inch conversion
- Variable data output  
RS 232 + Digimatic + USB

### Shipment

- Wooden case

⊗	⊗	Measuring range		Base length		Reading		Ref. No.	List price Euro
		mm	inch	mm	inch	mm	inch		
		150	6	100	4	0.01	.005	1360 716	304.00
		200	8	100	4	0.01	.0005	1360 718	345.00
		300	12	150	6	0.01	.0005	1360 722	387.00
		500	20	150	6	0.01	.0005	1360 728	445.00
		1000	39	250	10	0.01	.0005	1360 734	1,266.00
	▪	1500*	59	250	10	0.01	.0005	1360 738	1,931.00
	▪	2000*	80	250	10	0.01	.0005	1360 740	2,292.00

\* Factory standard

Accessories	Ref. No.	List price Euro
Battery, 3V-Lithium, CR 2032	0220 704	3.60
Cable for USB, incl. software	1998 720	66.00
Cable for RS 232	1997 501	46.20
Cable for Digimatic	1998 501	59.00

Jean Louis MENEGON - Votre représentant et Conseiller- Tél. : 06 76 08 96 83

E-mail: [jlouismenegon@aol.com](mailto:jlouismenegon@aol.com) - web: [www.menegon-metrologie.com](http://www.menegon-metrologie.com)



## 1362 DIGI-MET® Depth gauges

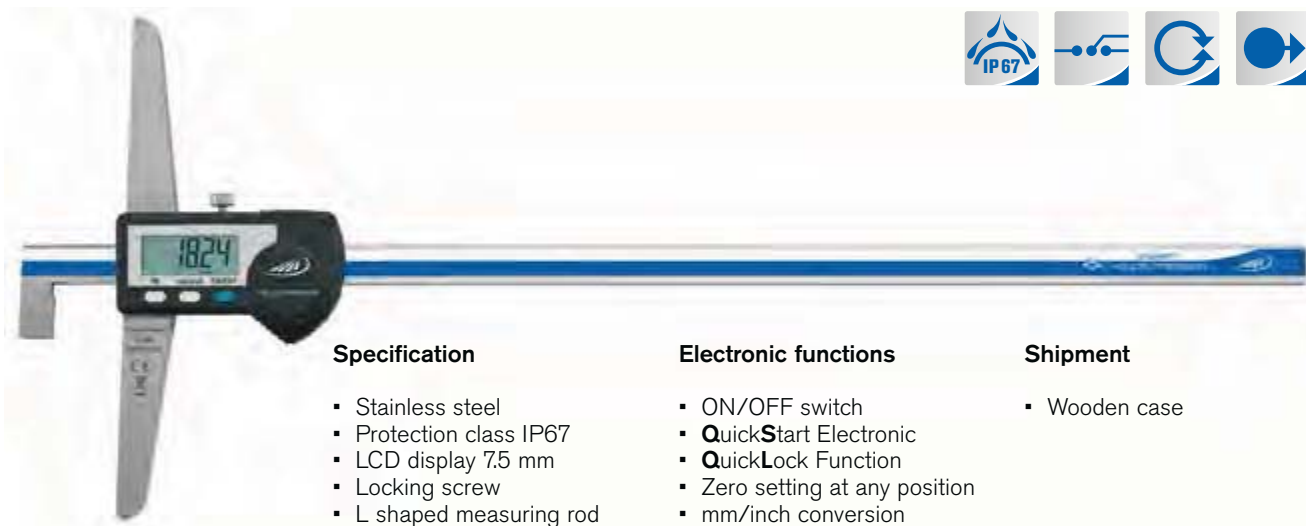

1

### Specification

- Stainless steel
- Protection class IP67
- LCD display 7.5 mm
- Locking screw
- L shaped measuring rod
- Larger measuring ranges are available upon request
- Factory standard

### Electronic functions

- ON/OFF switch
- **QuickStart** Electronic
- **QuickLock** Function
- Zero setting at any position
- mm/inch conversion
- Variable data output RS 232 + Digimatic + USB
- PRESET function (setting numerical value)

### Shipment

- Wooden case

		Measuring range		Base length		Reading		Ref. No.	List price Euro
		mm	inch	mm	inch	mm	inch		
▪		300	12	150	6	0.01	.0005	1362 722	397.00
▪		500	20	150	6	0.01	.0005	1362 728	461.00

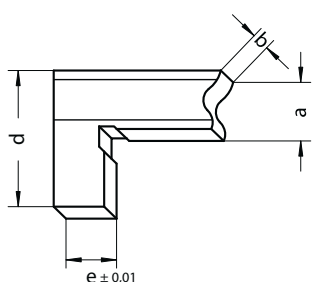

### Accessories

	Ref. No.	List price Euro
Battery, 3V-Lithium, CR 2032	0220 704	3.60
Cable for USB, incl. software	1998 720	66.00
Cable for Opto to RS 232	1997 501	46.20
Cable for Digimatic	1998 501	59.00

Jean Louis MENEGON - Votre représentant et Conseiller- Tél. : 06 76 08 96 83

E-mail: [jlouismenegon@aol.com](mailto:jlouismenegon@aol.com) - web: [www.menegon-metrologie.com](http://www.menegon-metrologie.com)





### 1364 DIGI-MET® Depth gauges



#### Specification

- Stainless steel
- Protection class IP67
- LCD display 7.5 mm
- DIN 862
- Locking screw
- Replaceable pin, dia. 2 x 5 mm
- Larger measuring ranges are available upon request

#### Electronic functions

- ON/OFF switch
- **QuickStart** Electronic
- **QuickLock** Function
- Zero setting at any position
- mm/inch conversion
- Variable data output RS 232 + Digimatic + USB

#### Shipment

- Wooden case

		Measuring range		Base length		Reading		Ref. No.	List price Euro
		mm	inch	mm	inch	mm	inch		
▪		200	8	100	6	0.01	.0005	1364 722	375.00
▪		300	12	150	6	0.01	.0005	1364 728	418.00

Accessories	Ref. No.	List price Euro
Battery, 3V-Lithium, CR 2032	0220 704	3.60
Cable for USB, incl. software	1998 720	66.00
Cable for RS 232	1997 501	46.20
Cable for Digimatic	1998 501	59.00

### Replacement measuring



		Ref. No.	List price Euro
		0276 711	5.90

Jean Louis MENEGON - Votre représentant et Conseiller- Tél. : 06 76 08 96 83  
 E-mail: [jlouismenegon@aol.com](mailto:jlouismenegon@aol.com) - web: [www.menegon-metrologie.com](http://www.menegon-metrologie.com)



# HELIOS • PREISSER

## 1371 DIGI-MET® Depth gauges



1



### Specification

- Stainless steel
- Inductive measuring system, protection class IP67
- DIN 862
- Locking screw
- LCD display 11 mm
- Measuring pin dia. 1.5 mm

### Electronic functions

- ON/OFF switch
- **QuickStart** Electronic
- **QuickLock** Function
- Zero setting at any position
- mm/inch conversion
- PRESET Function (setting a numerical value)

### Shipment

- Wooden case

Icon	Icon	Measuring range		Base length		Reading		Ref. No.	List price Euro
		mm	inch	mm	inch	mm	inch		
▪		150	6	100	4	0.01	.0005	1371 416	358.00
▪		300	12	150	6	0.01	.0005	1371 422	439.00
▪		500	20	150	6	0.01	.0005	1371 428	505.00

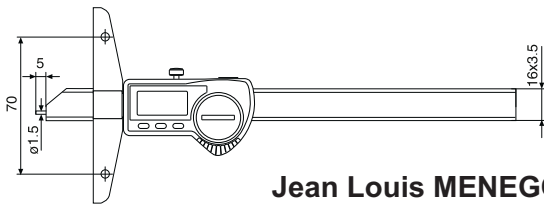

### Accessories

Battery, 3V-Lithium, CR 2032

### Ref. No.

0220 704

### List price Euro

3.60

**Jean Louis MENEGON** - Votre représentant et Conseiller- Tél. : 06 76 08 96 83

E-mail: [jlouismenegon@aol.com](mailto:jlouismenegon@aol.com) - web: [www.menegon-metrologie.com](http://www.menegon-metrologie.com)

## Extension depth attachment base

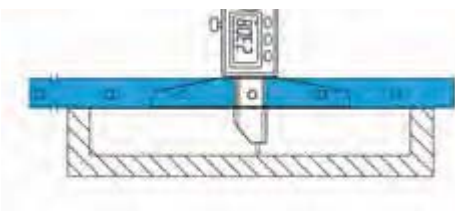

Icon	Icon	Depth attachment base length mm	Ref. No.	List price Euro
		200		
		300	1271 452	95.00

## Measuring insert for distance measurements

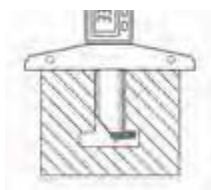

- To be attached to the measuring pin

Icon	Icon	Ref. No.	List price Euro
		1271 455	55.00



## 1368 DIGI-MET® Depth gauges

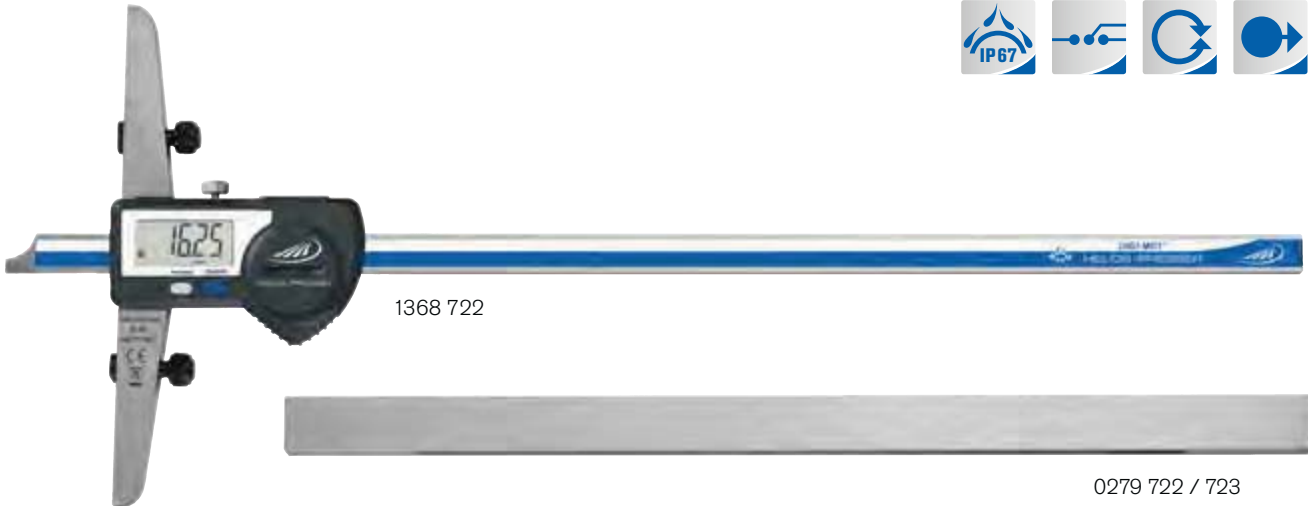

1368 722

0279 722 / 723

### Specification

- Stainless steel
- Inductive measuring system, protection class IP67
- LCD display 7,5 mm
- Locking screw
- The sliding measuring base must be ordered separately

### Electronic functions

- ON/OFF switch
- QuickStart Electronic
- QuickLock Function
- Zero setting at any position
- mm/inch conversion
- Variable data output RS 232 + Digimatic + USB

### Shipment

- Wooden case
- Without sliding measuring bridge (optional)

Icon	Icon	Measuring range		Base length		Reading		Ref. No.	List price Euro
		mm	inch	mm	inch	mm	inch		
		300	12	150	6	0.01	.0005	1368 722	397.00
		500	20	150	6	0.01	.0005	1368 728	451.00

### Accessories

	Ref. No.	List price Euro
Battery, 3V-Lithium, CR 2032	0220 704	3.60
Cable for USB, incl. software	1998 720	66.00
Cable for RS 232	1997 501	46.20
Cable for Digimatic	1998 501	59.00

## Sliding measuring base, stainless steel



Icon	Icon	Dimensions	Ref. No.	List price Euro
		mm		
		300 x 16	0279 722	251.00
		400 x 16	0279 723	263.00

Jean Louis MENEGON - Votre représentant et Conseiller- Tél. : 06 76 08 96 83

E-mail: [jlouismenegon@aol.com](mailto:jlouismenegon@aol.com) - web: [www.menegon-metrologie.com](http://www.menegon-metrologie.com)



# HELIOS • PREISSER

## 1366 DIGI-MET® Offset depth gauge

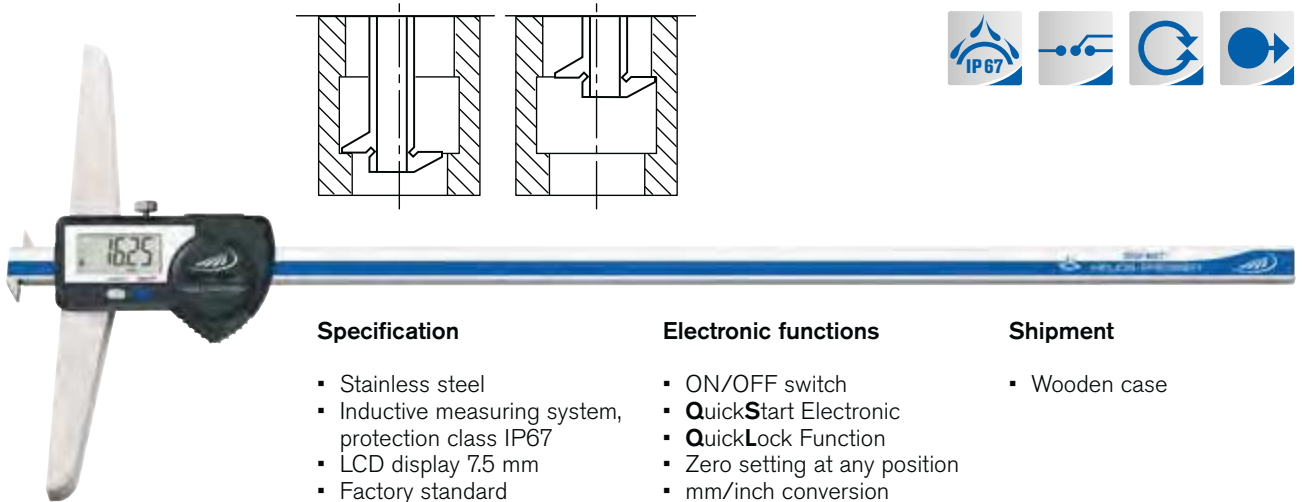

1

### Specification

- Stainless steel
- Inductive measuring system, protection class IP67
- LCD display 7.5 mm
- Factory standard
- Housing and operating keys have an excellent chemical resistance
- Locking screw

### Electronic functions

- ON/OFF switch
- **QuickStart** Electronic
- **QuickLock** Function
- Zero setting at any position
- mm/inch conversion
- Variable data output RS 232 + Digimatic + USB

### Shipment

- Wooden case

		Measuring range		Base length		Reading		Ref. No.	List price Euro
		mm	inch	mm	inch	mm	inch		
▪		200	8	100	4	0.01	.0005	1366 718	390.00
▪		300	12	150	6	0.01	.0005	1366 722	471.00
▪		500	20	150	6	0.01	.0005	1366 728	593.00

### Accessories

	Ref. No.	List price Euro
Battery, 3V-Lithium, CR 2032	0220 704	3.60
Cable for USB, incl. software	1998 720	66.00
Cable for RS 232	1997 501	46.20
Cable for Digimatic	1998 501	59.00

Jean Louis MENEGON - Votre représentant et Conseiller- Tél. : 06 76 08 96 83

E-mail: [jlouismenegon@aol.com](mailto:jlouismenegon@aol.com) - web: [www.menegon-metrologie.com](http://www.menegon-metrologie.com)



### 1379 DIGI-MET® Depth gauges with interchangeable inserts

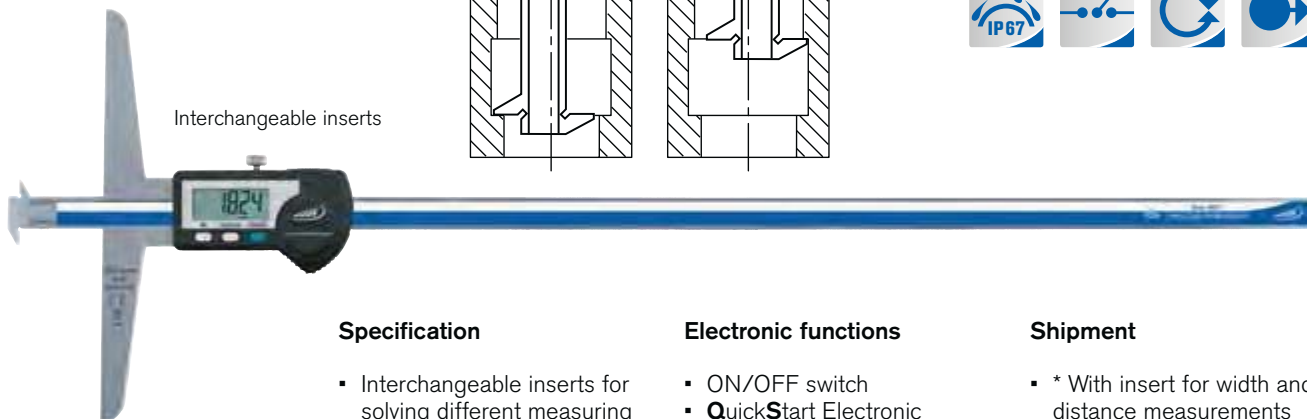

Interchangeable inserts

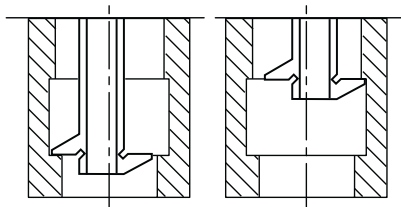

#### Specification

- Interchangeable inserts for solving different measuring tasks
- Measuring base can be attached (optional, see accessories)
- Stainless steel
- Inductive measuring system, protection class IP67
- Factory standard

#### Electronic functions

- ON/OFF switch
- **QuickStart** Electronic
- **QuickLock** Function
- Zero setting at any position
- mm/inch-conversion
- Variable data output RS 232 + Digimatic + USB
- PRESET Function (setting a numerical value)

#### Shipment

- \* With insert for width and distance measurements Ref. No. 1279 780
- Wooden case
- [More inserts and measuring base optional](#)

Marked *	Marked *	Measuring range		Base length		Reading		Ref. No.	List price Euro
		mm	inch	mm	inch	mm	inch		
▪		300	12	150	6	0.01	.0005	1379 722	612.00
▪		500	20	150	6	0.01	.0005	1379 728	844.00

#### Accessories

	Ref. No.	List price Euro
Battery, 3V-Lithium, CR 2032	0220 704	3.60
Cable for USB, incl. software	1998 720	66.00
Cable for RS 232	1997 501	46.20
Cable for Digimatic	1998 501	59.00

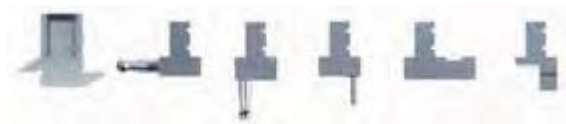

Jean Louis MENEGON - Votre représentant et Conseiller- Tél. : 06 76 08 96 83  
 E-mail: [jlouismenegon@aol.com](mailto:jlouismenegon@aol.com) - web: [www.menegon-metrologie.com](http://www.menegon-metrologie.com)





# HELIOS • PREISSER

## 1279 Interchangeable inserts made of stainless steel, hardened



1

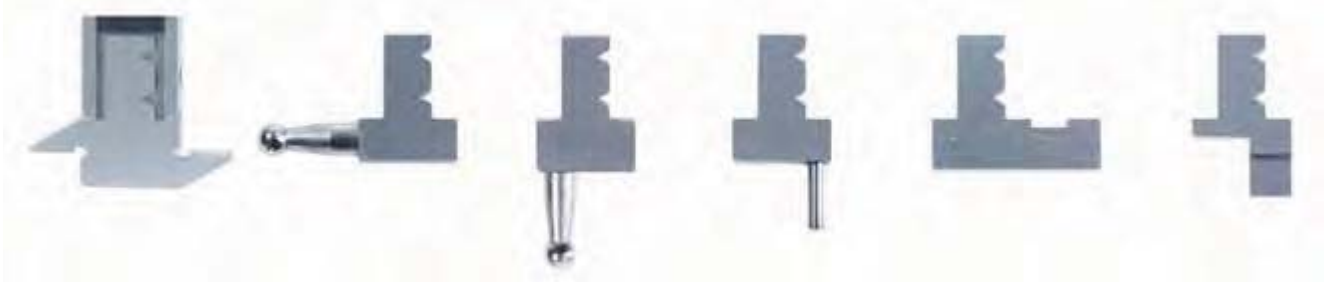

1279 780\*

1279 781

1279 782

1279 783

1279 784

1279 785

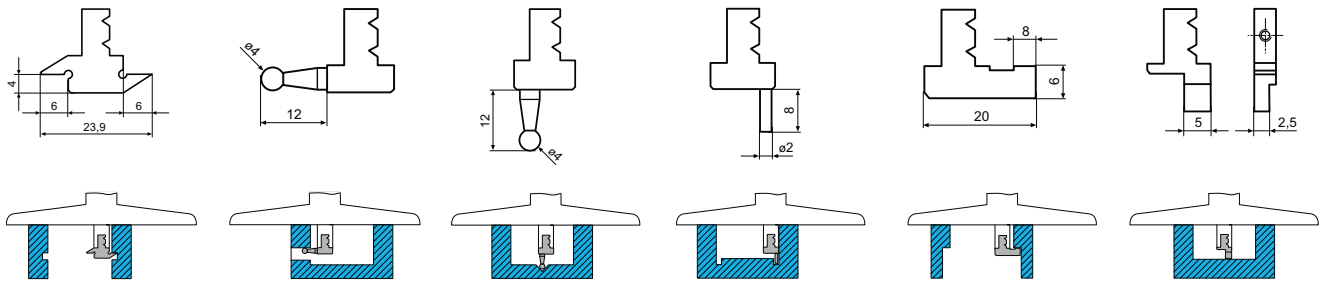

		Ref. No.	List price Euro
		1279 780*	105.00
		1279 781	105.00
		1279 782	105.00
		1279 783	105.00
		1279 784	105.00
		1279 785	105.00

\* Standard insert included in the delivery of the basic instrument

## Sliding measuring base made of stainless steel



		Dimensions mm	Ref. No.	List price Euro
		300 x 16	0279 722	251.00
		400 x 16	0279 723	263.00

Jean Louis MENEGON - Votre représentant et Conseiller- Tél. : 06 76 08 96 83  
E-mail: [jlouismenegon@aol.com](mailto:jlouismenegon@aol.com) - web: [www.menegon-metrologie.com](http://www.menegon-metrologie.com)



## 1375 DIGI-MET® Small depth gauge



### Specification

- Stainless steel
- Protection class IP67
- LCD display 7,5 mm
- Factory standard
- Measuring pin, dia. 2 mm

### Shipment

- Wooden case

### Electronic functions

- ON/OFF switch
- **QuickStart** Electronic
- **QuickLock** Function
- Zero setting at any position
- mm/inch conversion
- Variable data output RS 232 + Digimatic + USB
- PRESET Function (setting a numerical value)



		Measuring range		Base length		Reading		Ref. No.	List price Euro
		mm	inch	mm	inch	mm	inch		
		25	1	48	1.89	0.01	.0005	1375 502	230.00

Accessories	Ref. No.	List price Euro
Battery, 3V-Lithium, CR 2032	0220 704	3.60
Cable for USB, incl. software	1998 720	66.00
Cable for RS 232	1997 501	46.20
Cable for Digimatic	1998 501	59.00

Jean Louis MENEGON - Votre représentant et Conseiller- Tél. : 06 76 08 96 83

E-mail: [jlouismenegon@aol.com](mailto:jlouismenegon@aol.com) - web: [www.menegon-metrologie.com](http://www.menegon-metrologie.com)



# HELIOS • PREISSER

## 1376 DIGI-MET® Depth gauge



1

### Specification

- Stainless steel
- LCD display 7,5 mm
- Locking screw
- Factory standard

### Electronic functions

- ON/OFF switch
- **QuickStart** Electronic
- **QuickLock** Function
- Zero setting at any position
- mm/inch conversion
- Variable data output

### Shipment

- Wooden case

- RS 232 + Digimatic + USB
- Reversal of counting direction
- PRESET Function (setting a numerical value)

### Example of use

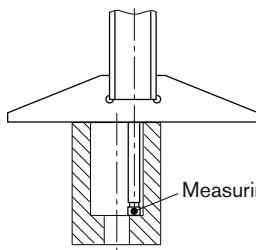

Measuring insert Ø 4 mm

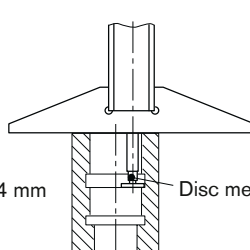

Disc measuring insert

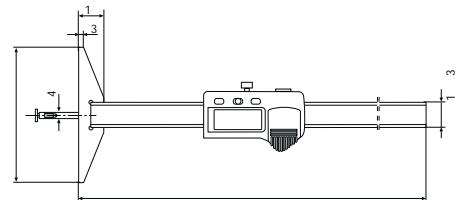

Icon	Measuring range		Base length		Reading		Ref. No.	List price Euro
	mm	inch	mm	inch	mm	inch		
	100	4	85	3.4	0.01	.0005	1376 514	477.00

### Standard accessories

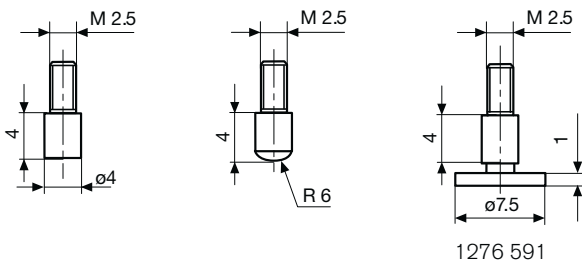

1276 591

### Accessories

	Ref. No.	List price Euro
Disc type measuring insert dia. 7.5 x 1 mm	1276 591	17.30
Battery, 3V-Lithium, CR 2032	0220 704	3.60
Cable for USB, incl. software	1998 720	66.00
Cable for RS 232	1997 501	46.20
Cable for Digimatic	1998 501	59.00

Jean Louis MENEGON - Votre représentant et Conseiller- Tél. : 06 76 08 96 83

E-mail: [jlouismenegon@aol.com](mailto:jlouismenegon@aol.com) - web: [www.menegon-metrologie.com](http://www.menegon-metrologie.com)





Jean Louis MENEGON - Votre représentant et Conseiller- Tél. : 06 76 08 96 83  
 E-mail: [jlouismenegon@aol.com](mailto:jlouismenegon@aol.com) - web: [www.menegon-metrologie.com](http://www.menegon-metrologie.com)

## 1378 DIGI-MET® Depth gauges for one-handed operation



### Specification

- Stainless steel
- Inductive measuring system, protection class IP67
- Locking screw
- Factory standard
- Constant measuring force through spring pressure
- Measuring pin with thread M 2.5 for exchangeable measuring inserts for core hole bores, also compatible with dial gauge inserts (see No. 0710) for depth measurement
- Measuring inserts for **core hole bores** (for additional costs) see table

### Electronic functions

- ON/OFF switch
- QuickStart Electronic
- QuickLock Function
- Zero setting at any position
- mm/inch conversion
- Variable data output RS 232 + Digimatic + USB
- PRESET Function (setting a numerical value)

### Shipment

- Wooden case
- ball measuring inserts for depth measurement included

Icon 1	Icon 2	Measuring range				Reading		Ref. No.	List price Euro
		mm	inch	mm	inch				
		0 - 60	0 - 2.4	0.01	.0005	1378 505	728.00		
		0 - 100	0 - 4.0	0.01	.0005	1378 508	783.00		

### Measuring inserts for core hole bores

Icon 1	Icon 2	Thread size	Core diameter	Measuring insert diameter	Ref. No.	List price Euro
		mm	mm	mm		
		M 16 x 1.5	14.38	14.32	1278 923	26.00
		M 16 x 1	14.92	14.87	1278 924	26.00
		M 12 x 1.25	10.65	10.59	1278 936	26.00
		M 12 x 1	10.92	10.87	1278 938	26.00
		M 10 x 1	8.92	8.87	1278 940	26.00
		M 10 x 0.75	9.19	9.13	1278 942	26.00
		M 8 x 1	6.92	6.87	1278 944	26.00
		M 8 x 0.75	7.19	7.14	1278 946	26.00
		M 6 x 0.75	5.19	5.14	1278 948	26.00
		M 5 x 0.5	4.46	4.41	1278 950	26.00
		M 16	13.84	13.79	1278 952	26.00
		M 12	10.11	10.05	1278 954	26.00
		M 10	8.38	8.32	1278 956	26.00
		M 8	6.65	6.59	1278 958	26.00
		M 6	4.92	4.87	1278 960	26.00
		M 5	4.13	4.08	1278 962	26.00
		16 pieces - set			1278 930	381.00

Measuring inserts for core hole bores

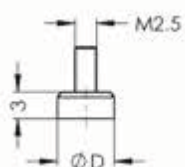

Reduction

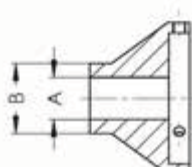

### Reductions for smaller surface contacts

Type	Dim. A mm	Dim. B mm	Ref. No.	List price Euro
6/12	dia. 6	dia. 12	1278 912	105.00
9.5/16	dia. 9.5	dia. 16	1278 916	105.00
15/20	dia. 15	dia. 20	1278 920	105.00



# HELIOS • PREISSER

## 0273 DIGI-MET® Mounting scales



1

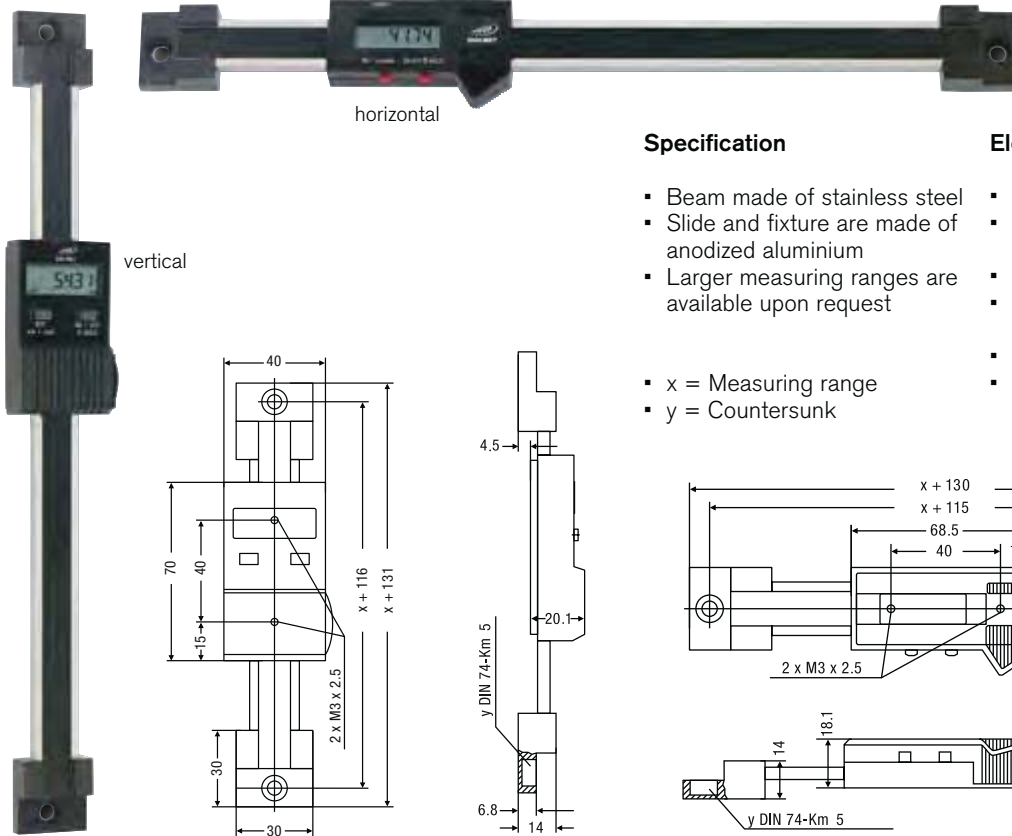

### Specification

- Beam made of stainless steel
- Slide and fixture are made of anodized aluminium
- Larger measuring ranges are available upon request
- x = Measuring range
- y = Countersunk

### Electronic functions

- ON/OFF switch
- Zero setting at any position
- mm/inch conversion
- Data output Opto RS 232
- Hold Function
- PRESET Function (setting a numerical value)

	Measuring range	mm		LCD display	Reading		Ref. No.	List price
		mm	inch		mm	mm		
<b>Horizontal</b>								
	150	6		6	0.01	.0005	0273 731	190.00
	200	8		6	0.01	.0005	0273 732	195.00
	300	12		6	0.01	.0005	0273 735	200.00
	450	18		6	0.01	.0005	0273 738	224.00
	600	24		6	0.01	.0005	0273 741	272.00
	800	31		6	0.01	.0005	0273 745	476.00
	1000	39		6	0.01	.0005	0273 746	519.00
<b>Vertical</b>								
	150	6		6	0.01	.0005	0273 751	340.00
	200	8		6	0.01	.0005	0273 752	345.00
	300	12		6	0.01	.0005	0273 755	350.00
	450	18		6	0.01	.0005	0273 758	368.00
	600	24		6	0.01	.0005	0273 761	414.00
	800	31		6	0.01	.0005	0273 765	581.00
	1000	39		6	0.01	.0005	0273 766	625.00

### Accessories

	Ref. No.	List price
		Euro
Battery, 3V-Lithium, CR 2032	0220 704	3.60
Cable for Opto to RS 232	0996 701	71.00
Cable for Opto to USB	0996 705	136.00
USB-keyboard interface cable Opto RS 232	0997 770	232.00



## 0003 Wooden cases with foam padding



Standard packaging:  
Cardboard box with  
cutout insert

		Measuring range mm	Jaw length mm	Internal dimensions L x B x H mm	Ref. No.	List price Euro
<b>For calipers with knife points</b>						
		160	40	250 x 90 x 20	0003 219	7.10
		200	80	315 x 130 x 20	0003 220	8.50
		250	80	370 x 145 x 20	0003 221	10.70
		300	90	435 x 175 x 20	0003 222	14.80
		400	125	590 x 220 x 20	0003 225	32.40
		400	150	590 x 250 x 20	0003 226	38.70
		400	200	590 x 300 x 20	0003 227	35.40
		500	150	690 x 250 x 21	0003 229	44.30
		500	200	700 x 315 x 21	0003 230	45.40
		500	250	700 x 350 x 21	0003 231	46.40
		600	150	790 x 250 x 21	0003 233	56.00
		600	200	790 x 300 x 21	0003 234	62.00
		800	150	1000 x 270 x 21	0003 237	61.00
		800	200	1000 x 320 x 21	0003 238	62.00
		800	300	1000 x 420 x 21	0003 240	80.00
		1000	150	1200 x 270 x 21	0003 243	81.00
		1000	200	1200 x 320 x 21	0003 244	91.00
		1000	300	1230 x 420 x 21	0003 246	109.00
		1250	200	1520 x 380 x 25	0003 249	106.00
		1250	300	1520 x 440 x 25	0003 250	135.00
		1500	200	1800 x 380 x 25	0003 252	152.00
		1500	300	1800 x 440 x 25	0003 253	181.00
		2000	200	2300 x 380 x 25	0003 255	278.00
		2000	300	2300 x 460 x 25	0003 256	263.00
		3000	200	3310 x 400 x 25	0003 258	294.00
		3000	300	3310 x 460 x 25	0003 259	340.00

Jean Louis MENEGON - Votre représentant et Conseiller- Tél. : 06 76 08 96 83

E-mail: [jlouismenegon@aol.com](mailto:jlouismenegon@aol.com) - web: [www.menegon-metrologie.com](http://www.menegon-metrologie.com)





## 0003 Wooden cases with foam padding



		Measuring range mm	Jaw length mm	Internal dimensions L x B x H mm	Ref. No.	List price Euro
<b>For calipers without knife points</b>						
		160	40	250 x 90 x 20	0003 219	7.10
		200	80	315 x 130 x 20	0003 220	8.50
		250	80	370 x 145 x 20	0003 221	10.70
		300	90	435 x 175 x 20	0003 222	14.80
		300	150	435 x 205 x 20	0003 223	16.60
		400	125	610 x 180 x 20	0003 224	24.90
		400	150	590 x 220 x 20	0003 225	32.40
		400	200	590 x 250 x 20	0003 226	38.70
		500	150	690 x 200 x 20	0003 228	43.10
		500	200	690 x 250 x 21	0003 229	44.30
		500	250	700 x 315 x 21	0003 230	45.40
		600	150	790 x 200 x 21	0003 232	46.40
		600	200	790 x 250 x 21	0003 233	56.00
		600	300	810 x 400 x 21	0003 235	67.00
		800	150	1000 x 220 x 21	0003 236	57.00
		800	200	1000 x 270 x 21	0003 237	61.00
		800	300	1000 x 380 x 21	0003 239	69.00
		800	400	1100 x 480 x 21	0003 241	80.00
		1000	150	1200 x 220 x 21	0003 242	76.00
		1000	200	1200 x 270 x 21	0003 243	81.00
		1000	300	1200 x 380 x 21	0003 245	101.00
		1000	500	1300 x 600 x 25	0003 247	125.00
		1250	200	1520 x 310 x 25	0003 248	106.00
		1250	300	1520 x 380 x 25	0003 249	106.00
		1500	200	1800 x 310 x 25	0003 251	141.00
		1500	300	1800 x 380 x 25	0003 252	152.00
		2000	200	2300 x 310 x 25	0003 254	236.00
		2000	300	2300 x 380 x 25	0003 255	278.00
		3000	200	3310 x 310 x 25	0003 257	283.00
		3000	300	3310 x 400 x 25	0003 258	294.00

Jean Louis MENEGON - Votre représentant et Conseiller- Tél. : 06 76 08 96 83

E-mail: [jlouismenegon@aol.com](mailto:jlouismenegon@aol.com) - web: [www.menegon-metrologie.com](http://www.menegon-metrologie.com)



## YOU ARE VALUABLE TO US

We think more, we achieve more, we offer more to create added value for our customers. This not only sounds good in theory, it's demonstrated in everything that we do every day, creating some quite interesting perspectives ...

- the HELIOS-PREISSER brand stands for a tradition of premium quality with maximum precision;
- the wide and extensive product range offers everything professionals look for, need and want;
- our small company size makes us an approachable partner, flexible enough to handle fast turnaround times, customisation requests, and providing service in a class of its own.

What two entrepreneurs started 75 years ago has come together in 2015 to walk a common path into the future. We are certain that this is a road to success because our goal is and will always be to go the extra mile.



## 2. CHAPTER MICROMETERS

86	External micrometers
93	Digital external micrometers
96	Precision dial micrometers
97	External micrometers with special measuring faces
99	Setting standards for micrometers
100	External micrometers for thread flank measurement
103	External micrometers for gear tooth measurements
104	Wire micrometers
105	Internal micrometers
111	Digital internal micrometers / with measuring pistol
115	Depth micrometers





### 0800 External micrometers



DIN 863-1



#### Specification

- DIN 863-1
- Reading: 0.01 mm
- Reading parts are satin chrome finished
- Locking lever
- Ratchet stop
- Carbide measuring faces
- Thermally insulated

#### Shipment

- From measuring range 25 - 50 mm upwards includes a setting gauge
- Plastic case

⌘	⚙	Measuring range mm	Spindle dia. mm	Thimble dia. mm	Pitch mm	Ref. No.	List price Euro
		0 - 25	6.5	17	0.5	0800 501	17.40
		25 - 50	6.5	17	0.5	0800 502	21.20
		50 - 75	6.5	17	0.5	0800 503	24.30
		75 - 100	6.5	17	0.5	0800 504	28.70

### 0800 Set of external micrometers



DIN 863-1



#### Shipment

- Includes 4 external micrometers
- Incl. setting gauges 25/50/75 mm
- Wooden case

⌘	⚙	Measuring range mm	Spindle dia. mm	Thimble dia. mm	Pitch	Ref. No.	List price Euro
		0 - 100	6.5	17	0.5	0800 513	102.00

### 0807 Holder for external micrometers



#### Specification

- With heavy cast iron base
- Vertically rotating and lockable

#### Shipment

- Cardboard box

⌘	⚙	For measuring range mm	Ref. No.	List price Euro
		0 - 300	0807 101	52.00

Jean Louis MENEGON - Votre représentant et Conseiller- Tél. : 06 76 08 96 83

E-mail: [jlouismenegon@aol.com](mailto:jlouismenegon@aol.com) - web: [www.menegon-metrologie.com](http://www.menegon-metrologie.com)



## 0806 External micrometers with friction clutch



**DIN  
863-1**



### Specification

- DIN 863-1
- Reading: 0.01 mm
- Reading parts are satin chrome finished
- Locking lever
- With friction clutch (ratchet)
- Fixed quick drive
- Carbide measuring faces
- Thermally insulated

### Shipment

- From measuring range 25 - 50 mm includes a setting gauge
- Plastic case

⊗	☒	Measuring range mm	Spindle dia. mm	Thimble dia. mm	Pitch mm	Ref. No.	List price Euro
		0 - 25	6.5	18	0.5	0806 501	31.50
		25 - 50	6.5	18	0.5	0806 502	34.50
		50 - 75	6.5	18	0.5	0806 503	37.50
		75 - 100	6.5	18	0.5	0806 504	40.50

2

## 0806 Set of external micrometers with friction clutch



**DIN  
863-1**



### Shipment

- Includes 4 external micrometers
- incl. setting gauges 25/50/75 mm
- Wooden case

⊗	☒	Measuring range mm	Spindle dia. mm	Thimble dia. mm	Pitch mm	Ref. No.	List price Euro
		0 - 100	6.5	18	0.5	0806 513	148.00

**Jean Louis MENEGON** - Votre représentant et Conseiller- Tél. : 06 76 08 96 83

E-mail: [jlouismenegon@aol.com](mailto:jlouismenegon@aol.com) - web: [www.menegon-metrologie.com](http://www.menegon-metrologie.com)





## 0806 External micrometers



DIN 863-1



### Specification

- DIN 863-1
- Reading: 0.01 mm
- Reading parts are satin chrome finished
- Locking lever
- Ratchet stop
- Carbide measuring faces
- Thermally insulated
- Coated steel frame

### Shipment

- From measuring range 25 - 50 mm upwards includes a setting gauge
- Plastic case

⌘	⚙	Measuring range mm	Spindle dia. mm	Thimble dia. mm	Pitch mm	Ref. No.	List price Euro
		0 - 25	6.5	17.5	0.5	0806 521	43.10
		25 - 50	6.5	17.5	0.5	0806 522	68.00
		50 - 75	6.5	17.5	0.5	0806 523	84.00
		75 - 100	6.5	17.5	0.5	0806 524	97.00
		100 - 125	6.5	17.5	0.5	0806 525	132.00
		125 - 150	6.5	17.5	0.5	0806 526	148.00
		150 - 175	6.5	17.5	0.5	0806 527	165.00
		175 - 200	6.5	17.5	0.5	0806 528	181.00

## 0806 Set of external micrometers



DIN 863-1



### Shipment

- Includes 4 external micrometers
- Incl. setting gauges 25 + 75 mm or 125 + 175 mm
- Wooden case

⌘	⚙	Measuring range mm	Spindle dia. mm	Thimble dia. mm	Pitch mm	Ref. No.	List price Euro
		0 - 100	6.5	17.5	0.5	0806 540	254.00
		100 - 200	6.5	17.5	0.5	0806 542	559.00

Jean Louis MENEGON - Votre représentant et Conseiller- Tél. : 06 76 08 96 83

E-mail: [jlouismenegon@aol.com](mailto:jlouismenegon@aol.com) - web: [www.menegon-metrologie.com](http://www.menegon-metrologie.com)



## 0810 External micrometers



**DIN  
863-1**



### Specification

- DIN 863-1
- Reading: 0.01 mm
- Reading parts are satin chrome finished
- Locking ring
- Spheroid ductile iron frame, lacquered
- Ratchet stop
- Carbide measuring faces
- Thermally insulated

### Shipment

- Wooden case

⊗	☒	Measuring range mm	Spindle dia. mm	Thimble dia. mm	Pitch mm	Ref. No.	List price Euro
		0 - 25	8	30	1	0810 501	239.00
		25 - 50	8	30	1	0810 502	252.00
		50 - 75	8	30	1	0810 503	265.00
		75 - 100	8	30	1	0810 504	281.00

## 0815 External micrometers with deep frame



**DIN  
863-1**



### Specification

- DIN 863-1
- Reading: 0.01 mm
- Reading parts are satin chrome finished
- Steel bracket lacquered
- Ratchet stop
- Carbide measuring faces

### Shipment

- Wooden case

⊗	☒	Meas. range x frame depth mm	Spindle dia. mm	Thimble dia. mm	Pitch mm	Max. error µm	Ref. No.	List price Euro
		0 - 25 x 100	8	24	1	3	0815 510	251.00
		0 - 25 x 150	6.5	24	1	5	0815 514	265.00
		0 - 25 x 250	6.5	24	1	7	0815 518	331.00
		0 - 50 x 50	8	24	1	3	0815 530	285.00
		0 - 50 x 100	8	24	1	4	0815 534	421.00
		50 - 100 x 100	8	24	1	4	0815 540	465.00

Jean Louis MENEGON - Votre représentant et Conseiller- Tél. : 06 76 08 96 83

E-mail: [jlouismenegon@aol.com](mailto:jlouismenegon@aol.com) - web: [www.menegon-metrologie.com](http://www.menegon-metrologie.com)



**0816 External micrometers large spindle distance 50 mm**



**DIN  
863-1**



**Specification**

- DIN 863-1
- Direct reading 0.01 mm, without addition because of thread pitch 1 mm
- Reading parts are satin chrome finished
- Locking ring
- Ratchet stop
- Carbide measuring faces
- Thermally insulated
- With 50 mm spindle movement and a wide measuring range
- Spheroid ductile iron frame, lacquered or coated light alloy frame

**Shipment**

- Wooden case

		Measuring range mm	Spindle dia. mm	Thimble dia. mm	Pitch mm	Ref. No.	List price Euro
		0 - 50	8	24	1	0816 501	300.00
		50 - 100	8	24	1	0816 502	339.00
		100 - 150	8	24	1	0816 503	391.00
		150 - 200	8	24	1	0816 504	447.00
		200 - 250	8	24	1	0816 505	508.00
		250 - 300	8	24	1	0816 506	574.00
		300 - 350	10	24	1	0816 507*	810.00
		350 - 400	10	24	1	0816 508*	856.00
		400 - 450	10	24	1	0816 509*	909.00
		450 - 500	10	24	1	0816 510*	975.00
		500 - 550	10	24	1	0816 511*	1,052.00
		550 - 600	10	24	1	0816 512*	1,126.00

**Jean Louis MENEGON - Votre représentant et Conseiller- Tél. : 06 76 08 96 83**

E-mail: [jlouismenegon@aol.com](mailto:jlouismenegon@aol.com) - web: [www.menegon-metrologie.com](http://www.menegon-metrologie.com)



# HELIOS • PREISSER

## 0817 External micrometers with wide range of applications 100 mm



DIN  
863-3



2

### Specification

- DIN 863-3
- Direct reading 0.01 mm, without addition because of thread pitch 1mm
- Reading parts are satin chrome finished
- Spindle adjustment 50 mm
- Reversible anvil (screwed) for measuring range extension
- Locking ring
- Ratchet stop
- Carbide measuring faces
- Thermally insulated
- Robust coated light alloy frame

### Shipment

- Wooden case

		Measuring range mm	Spindle dia. mm	Thimble dia. mm	Pitch mm	Max. error µm	Ref. No.	List price Euro
		200 - 300	10	24	1	6	0817 512	967.00
		300 - 400	10	24	1	7	0817 514	1,006.00
		400 - 500	10	24	1	8	0817 516	1,126.00
		500 - 600	10	24	1	9	0817 518	1,277.00
		600 - 700	10	24	1	9	0817 520	1,429.00
	▪	700 - 800	10	24	1	9	0817 522	1,585.00
	▪	800 - 900	10	24	1	10	0817 524	1,745.00
	▪	900 - 1000	10	24	1	10	0817 526	1,931.00
	▪	1000 - 1100	10	24	1	11	0817 528	2,126.00
	▪	1100 - 1200	10	24	1	11	0817 530	2,326.00
	▪	1200 - 1300	10	24	1	12	0817 532	2,546.00
	▪	1300 - 1400	10	24	1	12	0817 534	2,821.00
	▪	1400 - 1500	10	24	1	13	0817 536	3,011.00
	▪	1500 - 1600	10	24	1	18	0817 538	4,714.00
	▪	1600 - 1700	10	24	1	19	0817 540	5,003.00
	▪	1700 - 1800	10	24	1	20	0817 542	5,383.00
	▪	1800 - 1900	10	24	1	21	0817 544	5,703.00
	▪	1900 - 2000	10	24	1	22	0817 546	6,059.00

## 0817 Replacement reversible anvil



		Length mm	Ref. No.	List price Euro
		Exchangeable for all measuring ranges 50	0817 910	151.00

Jean Louis MENEGON - Votre représentant et Conseiller- Tél. : 06 76 08 96 83

E-mail: [jlouismenegon@aol.com](mailto:jlouismenegon@aol.com) - web: [www.menegon-metrologie.com](http://www.menegon-metrologie.com)



## 0819 External micrometers with interchangeable inserts

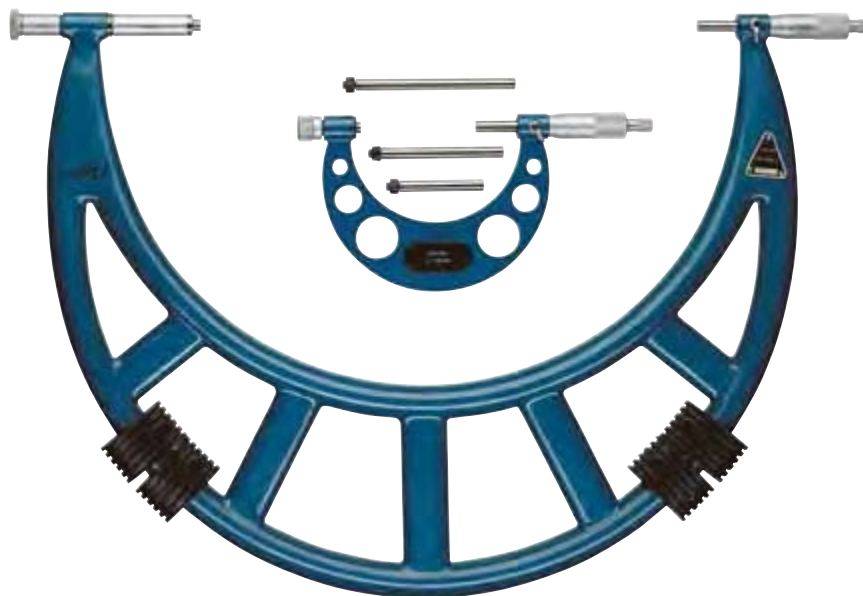

### Specification

- Reading: 0.01 mm
- Reading parts are satin chrome finished
- Locking lever
- Ratchet stop
- Carbide measuring faces
- Thermally insulated
- Coated malleable cast iron frame\* or coated light alloy frame with interchangeable anvil parts

### Shipment

- Includes a setting gauge
- Wooden case

		Measuring range mm	Spindle dia. mm	Thimble dia. mm	Pitch mm	Ref. No.	List price Euro
		0 - 100	8	20	0.5	0819 501*	170.00
		0 - 150	8	20	0.5	0819 502*	190.00
		100 - 200	8	20	0.5	0819 503*	210.00
		150 - 350	8	20	0.5	0819 505*	240.00
		200 - 300	8	20	0.5	0819 510*	230.00
		300 - 400	8	24	0.5	0819 511	290.00
		400 - 500	8	24	0.5	0819 512	330.00
		500 - 600	8	24	0.5	0819 513	380.00
		600 - 700	8	24	0.5	0819 514	470.00
	▪	700 - 800	8	24	0.5	0819 515	540.00
	▪	800 - 900	8	24	0.5	0819 516	620.00
	▪	900 - 1000	8	24	0.5	0819 517	700.00
	▪	1000 - 1200	8	24	1.0	0819 519	1,300.00
	▪	1200 - 1400	8	24	1.0	0819 521	1,400.00
	▪	1400 - 1600	8	24	1.0	0819 523	1,650.00
	▪	1600 - 1800	8	24	1.0	0819 525	1,895.00
	▪	1800 - 2000	8	24	1.0	0819 527	2,180.00

Jean Louis MENEGON - Votre représentant et Conseiller- Tél. : 06 76 08 96 83

E-mail: [jlouismenegon@aol.com](mailto:jlouismenegon@aol.com) - web: [www.menegon-metrologie.com](http://www.menegon-metrologie.com)





# HELIOS • PREISSER

## 0912 Digital micrometers



### Specification

- Protection class IP54
- Reading: 0.001 mm / .00005 inch
- Locking lever
- Ratchet stop
- Carbide measuring faces
- Thermally insulated
- Factory standard

### Electronic functions

- ON/OFF switch
- Automatic OFF
- Zero setting at any position
- mm/inch conversion

### Shipment

- From measuring range 25 mm upwards includes a setting gauges
- Plastic case

QuickLock	QuickStart	Measuring range		Spindle dia. mm	Pitch mm	Ref. No.	List price Euro
		mm	inch				
		0 - 25	0 - 1	6.5	0.5	0912 501	75.00
		25 - 50	1 - 2	6.5	0.5	0912 502	85.00
		50 - 75	2 - 3	6.5	0.5	0912 503	97.00
		75 - 100	3 - 4	6.5	0.5	0912 504	111.00
		100 - 125	4 - 5	6.5	0.5	0912 505	122.00
		125 - 150	5 - 6	6.5	0.5	0912 506	134.00
		150 - 175	6 - 7	6.5	0.5	0912 507	144.00
		175 - 200	7 - 8	6.5	0.5	0912 508	155.00

### Accessories

Battery 1,5V, type 357

### Ref. No.

0220 204

### List price

Euro

3.10

## 0912 Set of digital micrometers



### Shipment

- Includes 4 micrometers
- Incl. setting gauges 25/50/75 mm
- Wooden case

QuickLock	QuickStart	Measuring range mm	Spindle dia. mm	Pitch mm	Ref. No.	List price Euro
		0 - 100	6.5	0.5	0912 521	401.00

Jean Louis MENEGON - Votre représentant et Conseiller- Tél. : 06 76 08 96 83

E-mail: [jlouismenegon@aol.com](mailto:jlouismenegon@aol.com) - web: [www.menegon-metrologie.com](http://www.menegon-metrologie.com)



## 1865 Digital micrometers



### Specification

- DIN 863-1
- Reading: 0.001 mm/  
.00005 inch
- LCD display 7.5 mm
- Locking lever
- Rapid drive
- Carbide measuring faces
- Thermally insulated

### Electronic functions

- ON/OFF switch
- **QuickStart** Electronic
- **QuickLock** Function
- Zero setting at any position
- mm/inch conversion
- Absolute/Relative measurement

### Shipment

- From measuring range 25 mm upwards includes a setting gauge
- Plastic case

		Measuring range		Spindle dia. mm	Pitch mm	Ref. No.	List price Euro
		mm	inch				
		0 - 25	0 - 1	6.5	0.635	1865 510	181.00
		25 - 50	1 - 2	6.5	0.635	1865 513	234.00
		50 - 75	2 - 3	6.5	0.635	1865 517	321.00
		75 - 100	3 - 4	6.5	0.635	1865 520	370.00

### Accessories

	Ref. No.	List price Euro
Battery, 3V-Lithium, CR 2032	0220 704	3.60
Cable for USB, incl. software	1998 720	66.00
Cable for RS 232	1997 501	46.20
Cable for Digimatic	1998 501	59.00

Jean Louis MENEGON - Votre représentant et Conseiller- Tél. : 06 76 08 96 83

E-mail: [jlouismenegon@aol.com](mailto:jlouismenegon@aol.com) - web: [www.menegon-metrologie.com](http://www.menegon-metrologie.com)



## 0932 DIGI-MET® External micrometers



2

**Jean Louis MENEGON** - Votre représentant et Conseiller- Tél. : 06 76 08 96 83  
E-mail: [jlouismenegon@aol.com](mailto:jlouismenegon@aol.com) - web: [www.menegon-metrologie.com](http://www.menegon-metrologie.com)

### Specification

- Factory standard
- Selectable resolution  
0.01 mm / 0.001 mm;  
0.0005 inch /  
0.00005 inch
- LCD display 6 mm
- Positive counting
- direction
- Non-rotating spindle
- Linear measuring system
- Locking lever\*
- Carbide measuring faces  
dia. 8 mm
- Thermally insulated
- Ratchet stop

### Electronic functions

- ON/OFF switch
- Zero setting at any position
- mm/inch conversion
- Data output Opto RS 232
- Max/Min value memory
- Enter tolerance value
- Hold Function
- PRESET Function  
(setting a numerical value)

### Shipment

- Wooden case

⊗	⊗	Measuring range		Spindle dia. mm	Pitch mm	Ref. No.	List price Euro
		mm	inch				
		0 - 25	0 - 1	8	1	0932 701*	455.00
		25 - 50	1 - 2	8	1	0932 702*	530.00
		50 - 75	2 - 3	8	1	0932 703*	600.00
		75 - 100	3 - 4	8	1	0932 704*	650.00
		100 - 125	4 - 5	8	1	0932 705*	700.00
		125 - 150	5 - 6	8	1	0932 706*	750.00
		150 - 175	6 - 7	8	1	0932 707*	800.00
		175 - 200	7 - 8	8	1	0932 708*	900.00
<b>With lifter - retraction stroke 1.5 mm</b>							
		0 - 25	0 - 1	8	1	0932 731	580.00
		25 - 50	1 - 2	8	1	0932 732	600.00
		50 - 75	2 - 3	8	1	0932 733	650.00
		75 - 100	3 - 4	8	1	0932 734	700.00

### Accessories

	Ref. No.	List price Euro
Battery 3V-Lithium, CR 2032	0220 704	3.60
Cable Opto RS 232	0996 701	71.00
Cable Opto for USB	0996 705	136.00
USB-keyboard interface cable Opto RS 232	0997 770	232.00





### 0849 Precision dial micrometers



DIN 863-3



#### Specification

- DIN 863-3
- Reading: 0.01 mm
- Reading on the dial: 1 µm
- Reading parts are satin chrome finished
- Retraction stroke 1.5 mm
- Spindle made of hardened stainless steel
- Constant measuring force
- Locking lever
- Carbide measuring faces
- Thermally insulated
- Adjustable tolerance markers

#### Shipment

- Wooden case

⌘	⚡	Measuring range mm	Spindle dia. mm	Thimble dia. mm	Pitch mm	Ref. No.	List price Euro
		0 - 25	7.5	17.5	0.5	0849 501	680.00
		25 - 50	7.5	17.5	0.5	0849 502	809.00

### 0850 Precision dial micrometers



DIN 863-3

Jean Louis MENEGON - Votre représentant et Conseiller- Tél. : 06 76 08 96 83

E-mail: [jlouismenegon@aol.com](mailto:jlouismenegon@aol.com) - web: [www.menegon-metrologie.com](http://www.menegon-metrologie.com)



#### Specification

- DIN 863-3
- Reading: 0.01 mm
- Reading on the dial: 1 µm
- Reading parts are satin chrome finished
- Retraction stroke 1.2 mm
- Locking lever
- Carbide measuring faces
- Constant measuring force
- Thermally insulated
- Spindle made of hardened stainless steel
- Adjustable tolerance markers

#### Shipment

- Incl. dial comparator gauge, reading 0.001 mm
- Wooden case

⌘	⚡	Measuring range mm	Spindle dia. mm	Thimble dia. mm	Pitch mm	Ref. No.	List price Euro
		0 - 25	7.5	17.5	0.5	0850 511	538.00
		25 - 50	7.5	17.5	0.5	0850 512	597.00
		50 - 100	7.5	17.5	0.5	0850 514	634.00
		100 - 150	7.5	17.5	0.5	0850 516	678.00
		150 - 200	7.5	17.5	0.5	0850 518	709.00



## 0822 Disc micrometers



### Specification

- Factory standard
- Reading: 0.01 mm
- Carbide measuring faces
- Ratchet stop
- Disc dia. 60 mm
- Malleable cast iron frame, lacquered

### Shipment

- Wooden case

**Jean Louis MENEGON** - Votre représentant et Conseiller- Tél. : 06 76 08 96 83  
E-mail: [jlouismenegon@aol.com](mailto:jlouismenegon@aol.com) - web: [www.menegon-metrologie.com](http://www.menegon-metrologie.com)

⊗	☒	Measuring range mm	Spindle dia. mm	Thimble dia. mm	Pitch mm	Ref. No.	List price Euro
<b>Frame depth 50 mm</b>							
		0 - 15	6.5	20	1	0822 301	88.00
		0 - 25	6.5	20	1	0822 302	133.00
		0 - 50	6.5	20	1	0822 303	244.00
<b>Frame depth 100 mm</b>							
		0 - 50	6.5	20	1	0822 304	400.00

2

## 0824 Micrometers for tube wall measurement



**DIN  
863-3**

### Specification

- DIN 863-3
- Reading: 0.01 mm
- Reading parts are satin chrome finished
- Ratchet stop
- Hardened measuring faces
- Malleable cast iron frame, lacquered

### Shipment

- Cardboard box

⊗	☒	Measuring range mm	Spindle dia. mm	Thimble dia. mm	Pitch mm	Ref. No.	List price Euro
<b>Ball dia. 2.5 mm</b>							
		0 - 15	6.5	20	0.5	0824 302	167.00
<b>Ball dia. 6.5 mm</b>							
		0 - 25	6.5	20	0.5	0824 303	169.00



## 0854 Blade micrometers

DIN  
863-3

## Specification

- DIN 863-3
- Reading: 0.01 mm
- Reading parts are satin chrome finished
- Ratchet stop
- Thermally insulated
- Hardened spindle and anvil
- Coated steel frame

## Shipment

- From measuring range 25 - 50 mm upwards includes a setting gauge
- Plastic case

⌘	⚙	Measuring range mm	Spindle dia. mm	Thimble dia. mm	Pitch mm	Ref. No.	List price Euro
<b>Measuring faces dia. 0.8 x 7 mm</b>							
		0 - 25	8.0	17.5	0.5	0854 301	238.00
		25 - 50	8.0	17.5	0.5	0854 302	288.00
		50 - 75	8.0	17.5	0.5	0854 303	309.00
		75 - 100	8.0	17.5	0.5	0854 304	335.00

## 0855 Micrometers with reduced measuring faces

DIN  
863-3

## Specification

- DIN 863-3
- Reading: 0.01 mm
- Reading parts are satin chrome finished
- Locking lever
- Ratchet stop
- Carbide measuring faces
- Thermally insulated
- Hardened spindle and anvil
- Coated steel frame

## Shipment

- From measuring range 25 - 50 mm upwards includes a setting gauge
- Plastic case

⌘	⚙	Measuring range mm	Spindle dia. mm	Thimble dia. mm	Pitch mm	Ref. No.	List price Euro
<b>Measuring faces dia. 3 mm, length 8.5 mm</b>							
		0 - 25	6.5	17.5	0.5	0855 301	171.00
		25 - 50	6.5	17.5	0.5	0855 302	210.00
		50 - 75	6.5	17.5	0.5	0855 303	238.00
		75 - 100	6.5	17.5	0.5	0855 304	251.00

Jean Louis MENEGON - Votre représentant et Conseiller- Tél. : 06 76 08 96 83

E-mail: [jlouismenegon@aol.com](mailto:jlouismenegon@aol.com) - web: [www.menegon-metrologie.com](http://www.menegon-metrologie.com)



# HELIOS • PREISSER

## 0898 Setting gauges for micrometers



### Specification

- Rod
- Special steel, aged
- Hardened measuring faces
- Tolerance zone js2
- Thermally insulated
- Parallel lapped measuring faces

⌘	☒	Measuring range	Measuring faces dia.	Ref. No.	List price
		mm	mm		Euro
		25	6.5	0898 101	10.50
		50	6.5	0898 102	17.60
		75	6.5	0898 103	20.90
		100	6.5	0898 104	23.90
		125	6.5	0898 105	27.60
		150	6.5	0898 106	39.10
		175	6.5	0898 107	43.70
		200	6.5	0898 108	48.30
		225	6.5	0898 109	53.00
		250	6.5	0898 110	58.00
		275	6.5	0898 111	62.00
		300	10.0	0898 112	77.00
		325	10.0	0898 113	83.00
		350	10.0	0898 114	89.00
		375	10.0	0898 115	94.00
		400	10.0	0898 116	101.00
		425	10.0	0898 117	107.00
		450	10.0	0898 118	113.00
		475	10.0	0898 119	118.00
		500	10.0	0898 120	125.00
		525	10.0	0898 121	131.00
		550	10.0	0898 122	138.00
		575	10.0	0898 123	144.00
		600	10.0	0898 124	151.00
		625	10.0	0898 125	158.00
		650	10.0	0898 126	164.00
		675	10.0	0898 127	170.00
		700	10.0	0898 128	177.00
		725	10.0	0898 129	184.00
		750	10.0	0898 130	191.00
		775	10.0	0898 131	197.00
		800	10.0	0898 132	204.00
		825	10.0	0898 133	209.00
		850	10.0	0898 134	216.00
		875	10.0	0898 135	223.00
		900	10.0	0898 136	230.00
		925	10.0	0898 137	236.00
		950	10.0	0898 138	243.00
		975	10.0	0898 139	250.00
		1000	10.0	0898 140	256.00
	▪	1050	10.0	0898 142	268.00
	▪	1150	10.0	0898 146	294.00
	▪	1250	10.0	0898 150	322.00
	▪	1350	10.0	0898 154	347.00
	▪	1450	10.0	0898 158	374.00
	▪	1550	10.0	0898 162	600.00
	▪	1650	10.0	0898 166	629.00
	▪	1750	10.0	0898 170	658.00
	▪	1850	10.0	0898 174	687.00
	▪	1950	10.0	0898 178	715.00

Jean Louis MENEGON - Votre représentant et Conseiller - Tél. : 06 76 08 96 83

E-mail: [jlouismenegon@aol.com](mailto:jlouismenegon@aol.com) - web: [www.menegon-metrologie.com](http://www.menegon-metrologie.com)



## 0870 Precision micrometers for thread flank measurement

DIN  
863-3

## Specification

- DIN 863-3
- Reading 0.01 mm
- Reading parts are satin chrome finished
- Locking ring
- Ratchet stop
- Thermally insulated
- Spheroid ductile iron frame, lacquered

## Shipment

- Wooden case
- Thread flank inserts and setting standards must be ordered separately.

✕	⚙	Measuring range	Spindle adjustment	Thimble dia.	Pitch	Maximum error	Required length of setting standard	Ref. No.	List price
		mm	mm	mm	mm	mm	mm		Euro
For inserts with shank dimensions, dia. 3.5 x 13.5 mm									
		0 - 25	25	20	0.5	3	—	0870 301	284.00
		25 - 50	25	20	0.5	3	25	0870 302	296.00
		50 - 75	25	20	0.5	4	50	0870 303	319.00
		75 - 100	25	20	0.5	4	75	0870 304	348.00
		100 - 125	25	20	0.5	4	100	0870 305	381.00
		125 - 150	25	20	0.5	4	125	0870 306	415.00
		150 - 200	50	20	0.5	5	175	0870 307	591.00
		200 - 250	50	20	0.5	5	225	0870 309	646.00
		250 - 300	50	20	0.5	5	275	0870 311	710.00

Jean Louis MENEGON - Votre représentant et Conseiller- Tél. : 06 76 08 96 83

E-mail: [jlouismenegon@aol.com](mailto:jlouismenegon@aol.com) - web: [www.menegon-metrologie.com](http://www.menegon-metrologie.com)



## 0870 Thread flank inserts for external measurement



### Specification

- Made of hardened special steel and finely grinded
- Every insert is inscribed with the pitch details
- In a set (V-anvil + tapered anvil)
- Shank dimensions: 3.5 x 13.5 mm

		Flank angle	Applicable for UNC, UNF 60°	Pitch mm	Pitch range TPI mm	Ref. No.	List price Euro
<b>Metric ISO - threads</b>							
		60°	72 - 48	0.35 - 0.5		0870 901	107.00
		60°	44 - 32	0.6 - 0.8		0870 903	92.00
		60°	28 - 18	0.9 - 1.25		0870 905	92.00
		60°	16 - 11	1.5 - 2		0870 907	92.00
		60°	10 - 7	2.5 - 3.5		0870 909	92.00
		60°	6 - 4	4 - 6		0870 911	107.00
<b>Whitworth - threads</b>							
		55°			60 - 48	0870 921	116.00
		55°			40 - 32	0870 923	101.00
		55°			28 - 22	0870 925	101.00
		55°			20 - 16	0870 927	101.00
		55°			14 - 11	0870 929	101.00
		55°			10 - 7	0870 931	101.00
		55°			6 - 4	0870 933	116.00
<b>Metric ISO - Trapezoid threads (DIN 103)</b>							
		30°		1.5		0870 941	274.00
		30°		2		0870 943	199.00
		30°		3		0870 945	175.00
		30°		4		0870 947	175.00
		30°		5 - 6		0870 949	175.00
		30°		7 - 8		0870 951	175.00
		30°		9 - 10		0870 953	199.00
		30°		12 - 14		0870 955	274.00



## 0870 Thread flank setting gauges for external measurement



## Specification

- Measuring faces made of hardened special steel
  - One end is rounded, the lapped bore simplifies the fitting upon the conical insert
  - Thermally insulated handle
- **Note:**  
With trapezoid threads, every pitch requires a separate setting standard

		Length	Maximum error $\pm \mu\text{m}$	Available for the following pitches mm	Ref. No.	List price Euro
<b>Metric ISO - threads 60°</b>						
		25	3		0870 801	67.00
		50	3		0870 802	68.00
		75	3		0870 803	69.00
		100	4		0870 804	70.00
		125	4		0870 805	71.00
		175	4		0870 807	79.00
		225	4		0870 809	89.00
		275	4		0870 811	98.00
<b>Whitworth - threads 55°</b>						
		25	3		0870 821	67.00
		50	3		0870 822	68.00
		75	3		0870 823	69.00
		100	4		0870 824	74.00
		125	4		0870 825	75.00
		175	4		0870 827	86.00
		225	4		0870 829	99.00
		275	4		0870 831	113.00
<b>Metric ISO - Trapezoid threads 30° (DIN 103)</b>						
		25	4	2 / 3 / 4 / 5 - 6 / 7 - 8 / 9 - 10	0870 841*	147.00
		50	4	2 / 3 / 4 / 5 - 6 / 7 - 8 / 9 - 10	0870 842*	151.00
		75	4	2 / 3 / 4 / 5 - 6 / 7 - 8 / 9 - 10	0870 843*	155.00
		100	5	3 / 4 / 5 - 6 / 7 - 8 / 9 - 10 / 12 - 14	0870 844*	162.00
		125	5	4 / 5 - 6 / 7 - 8 / 9 - 10 / 12 - 14	0870 845*	175.00
		175	5	4 / 5 - 6 / 7 - 8 / 9 - 10 / 12 - 14	0870 847*	209.00
		225	5	5 - 6 / 7 - 8 / 9 - 10 / 12 - 14	0870 849*	255.00
		275	5	5 - 6 / 7 - 8 / 9 - 10 / 12 - 14	0870 851*	312.00

\* When ordering the respective pitch must be specified

Jean Louis MENEGON - Votre représentant et Conseiller- Tél. : 06 76 08 96 83

E-mail: [jlouismenegon@aol.com](mailto:jlouismenegon@aol.com) - web: [www.menegon-metrologie.com](http://www.menegon-metrologie.com)





# HELIOS • PREISSER

## 0864 Disc micrometers to measure gear tooth



**DIN  
863-3**



### Specification

- DIN 863-3
- Reading: 0.01 mm
- Reading parts are satin chrome finished
- Modul 0.8 - 6
- Ratchet stop
- Hardened measuring faces
- Locking ring
- Friction coupling
- Thermally insulated

### Shipment

- Wooden case

⊗	⊗	Measuring range mm	Disc dia. mm	Thimble dia. mm	Pitch mm	Ref. No.	List price Euro
		0 - 25	25.0	20.0	0.5	0864 321	305.00
		25 - 50	25.0	20.0	0.5	0864 322	366.00
		50 - 75	25.0	20.0	0.5	0864 323	397.00
		75 - 100	25.0	20.0	0.5	0864 324	430.00
		100 - 125	25.0	20.0	0.5	0864 325	465.00
		125 - 150	25.0	20.0	0.5	0864 326	498.00
		150 - 175	25.0	20.0	0.5	0864 327	535.00
		175 - 200	25.0	20.0	0.5	0864 328	572.00

2

## 0933 DIGI-MET® Disc micrometers to measure gear tooth



**OPTO**



### Specification

- Factory standard
- Selectable resolution 0.01 mm / 0.001 mm; 0.0005 inch / 0.00005 inch
- Non-rotating spindle
- Linear measuring system
- Locking lever
- Thermally insulated
- Ratchet stop

### Electronic functions

- ON/OFF switch
- Zero setting at any position
- mm/inch conversion
- Data output Opto RS 232
- Max/Min value memory
- Hold Function
- PRESET Function (setting a numerical value)
- Enter tolerance value

### Shipment

- Wooden case

⊗	⊗	Measuring range		Module	Spindle dia. mm	Disc dia. mm	Pitch mm	Ref. No.	List price Euro
		mm	inch						
		0 - 25	0 - 1	0.4	8	25	1	0933 701	750.00
		25 - 50	1 - 2	0.4	8	25	1	0933 702	825.00
		50 - 75	2 - 3	0.4	8	25	1	0933 703	875.00
		75 - 100	3 - 4	0.4	8	25	1	0933 704	925.00
		100 - 125	4 - 5	0.6	8	30	1	0933 705	975.00
		125 - 150	5 - 6	0.6	8	30	1	0933 706	1,025.00
		150 - 175	6 - 7	0.6	8	30	1	0933 707	1,075.00
		175 - 200	7 - 8	0.6	8	30	1	0933 708	1,150.00

Jean Louis MENEGON - Votre représentant et Conseiller- Tél. : 06 76 08 96 83

E-mail: [jlouismenegon@aol.com](mailto:jlouismenegon@aol.com) - web: [www.menegon-metrologie.com](http://www.menegon-metrologie.com)

	Ref. No.	List price Euro
Battery, 3V-Lithium, CR 2032	0220 704	3.60
Cable for Opto to RS 232	0996 701	71.00
Cable for Opto to USB	0996 705	136.00
USB-keyboard interface cable Opto RS 232	0997 770	232.00





## 0890 Wire thickness micrometer



### Specification

- Factory standard
- Reading: 0.01 mm
- Readings parts are satin chrome finished
- Ratchet stop
- Carbide measuring faces

### Shipment

- Cardboard box

		Measuring range mm	Spindle dia. mm	Thimble dia. mm	Pitch mm	Ref. No.	List price Euro
		0 - 10	6	18	0.5	0890 511	64.00

**Jean Louis MENEGON** - Votre représentant et Conseiller- Tél. : **06 76 08 96 83**  
 E-mail: [jlouismenegon@aol.com](mailto:jlouismenegon@aol.com) - web: [www.menegon-metrologie.com](http://www.menegon-metrologie.com)





0884 Internal micrometer with measuring jaws



DIN 863-4

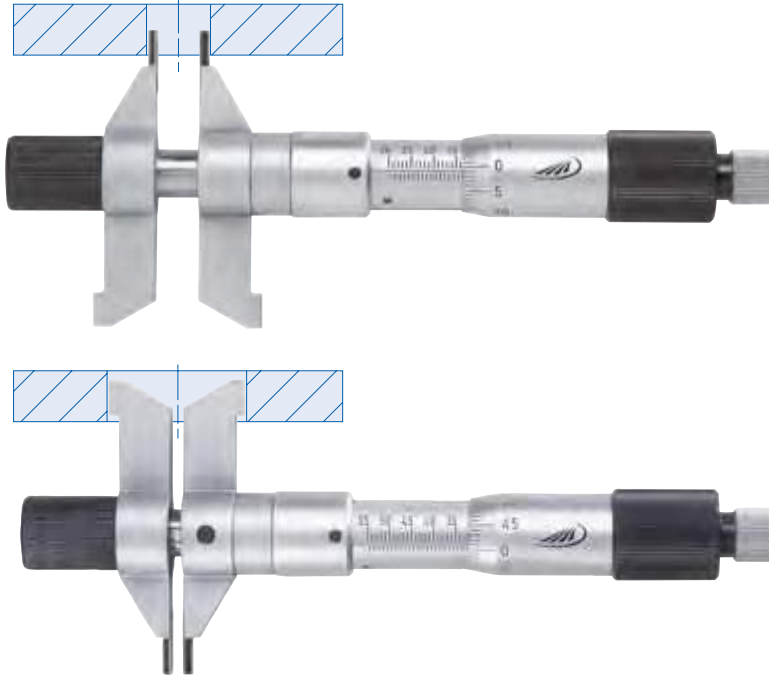

Specification

- DIN 863-4
- Reading: 0.01 mm
- Reading parts are satin chrome finished
- Forward friction coupling
- Cylindrical carbide tipped measuring faces
- Measuring jaws on both sides (Measuring ranges 5-30 mm, 30-55 mm)
- **Divisions on both sides**

Shipment

- Wooden case

		Measuring range mm	Thimble dia. mm	Pitch mm	Ref. No.	List price Euro
		5 - 55	20	0.5	0884 501	764.00

0885 Internal micrometers with measuring jaws



Jean Louis MENEGON - Votre représentant et Conseiller- Tél. : 06 76 08 96 83

E-mail: [jlouismenegon@aol.com](mailto:jlouismenegon@aol.com) - web: [www.menegon-metrologie.com](http://www.menegon-metrologie.com)



Specification

- Factory standard
- Reading: 0.01 mm
- Readings parts and body are satin chrome finished
- Ratchet stop
- Carbide measuring faces
- Cylindrical\* carbide tipped measuring faces

Shipment

- Plastic case

		Measuring range mm	Thimble dia. mm	Pitch mm	Ref. No.	List price Euro
		5 - 30	17	0.5	0885 501*	169.00
		25 - 50	17	0.5	0885 502	188.00
		50 - 75	17	0.5	0885 503	196.00
		75 - 100	17	0.5	0885 504	236.00
		100 - 125	17	0.5	0885 505	299.00
		125 - 150	17	0.5	0885 506	346.00
		150 - 175	17	0.5	0885 507	440.00
		175 - 200	17	0.5	0885 508	499.00



## 0888 Internal micrometers cylindrical version



## Specification

- DIN 863-4
- Reading: 0.01 mm
- Reading parts are satin chrome finished
- Carbide measuring faces dia. 6 mm, spherical lapped
- From measuring range 100 - 125 mm with thermal insulation
- From measuring range 100 - 125 mm with locking ring

## Shipment

- Wooden case

DIN  
863-4

⌘	📏	Measuring range mm	Thimble dia. mm	Pitch mm	Ref. No.	List price Euro
		25 - 30	15	0.5	0888 501	148.00
		30 - 35	15	0.5	0888 502	148.00
		35 - 50	15	0.5	0888 503	148.00
		50 - 75	16	0.5	0888 504	154.00
		75 - 100	17	0.5	0888 505	160.00
		100 - 125	20	0.5	0888 506	178.00
		125 - 150	20	0.5	0888 507	183.00
		150 - 175	20	0.5	0888 508	190.00
		175 - 200	20	0.5	0888 509	196.00
		200 - 225	20	0.5	0888 510	202.00
		225 - 250	20	0.5	0888 511	208.00
		250 - 275	20	0.5	0888 512	216.00
		275 - 300	20	0.5	0888 513	223.00
		300 - 325	20	0.5	0888 514	232.00
		325 - 350	20	0.5	0888 515	238.00
		350 - 375	20	0.5	0888 516	247.00
		375 - 400	20	0.5	0888 517	253.00
		400 - 425	20	0.5	0888 518	263.00
		425 - 450	20	0.5	0888 519	270.00
		450 - 475	20	0.5	0888 520	277.00
		475 - 500	20	0.5	0888 521	284.00

Jean Louis MENEGON - Votre représentant et Conseiller- Tél. : 06 76 08 96 83

E-mail: [jlouismenegon@aol.com](mailto:jlouismenegon@aol.com) - web: [www.menegon-metrologie.com](http://www.menegon-metrologie.com)

## 0888 Holder for internal micrometers



## Specification

- Ideal for all internal micrometers from series 0888 / 0892
- Length 200 mm



⌘	📏	Ref. No.	List price Euro
		0888 101	47.20



# HELIOS • PREISSER

## 0892 Internal micrometers interchangeable extensions



**DIN  
863-4**

### Specification

- DIN 863-4
- Reading: 0.01 mm
- Reading parts are satin chrome finished
- Threaded extension rods with thermally insulated handle
- Carbide measuring faces, spherical lapped

### Shipment

- Wooden case

		Measuring range mm	Extension rods mm	Thimble dia. mm	Pitch mm	Ref. No.	List price Euro
		50 - 150	25 / 50	17	0.5	0892 501	362.00
		50 - 250	25 / 50 / 100	17	0.5	0892 502	444.00
		50 - 450	25 / 50 / 100 / 200	17	0.5	0892 503	547.00
		50 - 850	25 / 50 / 100 / 200 / 400	17	0.5	0892 504	689.00
		50 - 1450	25 / 50 / 100 / 200 / 400 / 600	17	0.5	0892 505	875.00

## 0892 Extensions for internal micrometers



0892 334

		Length mm	Ref. No.	List price Euro
		25	0892 332	68.00
		50	0892 333	69.00
		100	0892 334	77.00
		200	0892 336	94.00
		400	0892 339	125.00
		600	0892 340	175.00

Jean Louis MENEGON - Votre représentant et Conseiller- Tél. : 06 76 08 96 83

E-mail: [jlouismenegon@aol.com](mailto:jlouismenegon@aol.com) - web: [www.menegon-metrologie.com](http://www.menegon-metrologie.com)



## 0894 Precision internal micrometers with extensions

DIN  
863-4

## Specification

- DIN 863-4
- Measuring ends: dia. 7 mm x 6 mm long, carbide tipped, spherical lapped
- Thread pitch 1 mm
- Internal spring mounted rods with thermal protective sleeves
- Extensions greater than 100 mm: external steel tube dia. 17 mm, with thermal insulation
- Extensions 500 and 1000 mm: strengthened specification - steel tube dia. 32 mm for larger measuring ranges

## Shipment

- Wooden case

⌘	⚙	Measuring range of the set mm	Maximum error µm	Length of extensions (tube dia. 17 mm) mm	Length of extensions (tube dia. 32 mm) mm	Ref. No.	List price Euro
		100 - 150	4	only micrometer, excludes case	—	0894 504	216.00
		100 - 300	7	50 / 100	—	0894 510	573.00
		100 - 500	9	50 / 100 / 200	—	0894 514	772.00
		100 - 900	11	50 / 100 / 200 / 400	—	0894 518	997.00
		100 - 1300	13	50 / 100 / 200 / 400 / 400	—	0894 522	1,228.00
		100 - 1700	15	50 / 100 / 200 / 400 / 800	—	0894 526	1,264.00
		100 - 2100	18*	50 / 100 / 200 / 400 / 400 / 800	—	0894 530	1,482.00
		100 - 2500	21*	50 / 100 / 200 / 400 / 800 / 800	—	0894 534	1,523.00
		100 - 2000	18*	50 / 100 / 200 / 200	500 / 1 x 1000	0894 538	2,657.00
		100 - 3000	30*	50 / 100 / 200 / 200	500 / 2 x 1000	0894 542	3,466.00
		100 - 4000	40*	50 / 100 / 200 / 200	500 / 3 x 1000	0894 546	4,302.00
	▪	100 - 5000	50*	50 / 100 / 200 / 200	500 / 4 x 1000	0894 550	5,112.00
	▪	100 - 6000	60*	50 / 100 / 200 / 200	500 / 5 x 1000	0894 554	5,921.00

\* With the larger measuring ranges we recommend that the ends of the precision internal micrometer to be placed and/or held on 2 points with an approximate distance of 22% of the measuring length, thus minimizing deflection. The error indicated in the table above refers to the maximum deflection of the appropriate set. When smaller dimensions are measured, the error is smaller and corresponds to the error value of the smaller sets.

Jean Louis MENEGON - Votre représentant et Conseiller- Tél. : 06 76 08 96 83

E-mail: [jlouismenegon@aol.com](mailto:jlouismenegon@aol.com) - web: [www.menegon-metrologie.com](http://www.menegon-metrologie.com)

## 0894 Individual extensions



⌘	⚙	Length mm	Tube dia. mm	Ref. No.	List price Euro
		50	17	0894 804	154.00
		100	17	0894 806	175.00
		200	17	0894 810	190.00
		400	17	0894 820	209.00
		800	17	0894 834	238.00
		500	32	0894 854	781.00
		1000	32	0894 872	810.00



## 1921 3 point internal micrometers



DIN  
863-4



For measurements  
up to bottom of hole

**Inclusive!**

2

### Specification

- DIN 863-4
- Reading: 0.001 mm\*
- Reading: 0.005 mm
- Reading parts are satin chrome finished
- Pitch 0.5 mm
- Carbide tipped measuring pins from measuring range 12 mm
- Ratchet stop
- From measuring range 12 mm for through and blind holes
- Calibration certificate for ring and device

### Shipment

- Plastic case
- Incl. setting ring

		Measuring range mm	Meas. depth mm	Thimble mm	Accuracy µm	Setting ring dia. mm	Ref. No.	List price Euro
▪		6 - 8	58	16	4	8	1921 510*	370.00
▪		8 - 10	58	16	4	10	1921 512*	370.00
▪		10 - 12	58	16	4	12	1921 514*	370.00
▪		12 - 16	64	16	4	16	1921 516*	370.00
▪		16 - 20	64	16	4	20	1921 518*	390.00
▪		20 - 25	68	25	4	25	1921 520	400.00
▪		25 - 30	68	25	4	30	1921 522	405.00
▪		30 - 40	76	25	4	40	1921 524	455.00
▪		40 - 50	76	25	4	50	1921 526	455.00
▪		50 - 60	79	25	5	60	1921 528	525.00
▪		60 - 70	79	25	5	70	1921 530	540.00
▪		70 - 85	97	25	5	85	1921 532	555.00
▪		85 - 100	97	25	5	100	1921 534	570.00
▪		100 - 125	132	25	6	125	1921 536	800.00
▪		125 - 150	132	25	6	150	1921 538	945.00
▪		150 - 175	132	25	7	175	1921 540	995.00
▪		175 - 200	132	25	7	200	1921 542	1,050.00

Jean Louis MENEGON - Votre représentant et Conseiller- Tél. : 06 76 08 96 83

E-mail: [jlouismenegon@aol.com](mailto:jlouismenegon@aol.com) - web: [www.menegon-metrologie.com](http://www.menegon-metrologie.com)



## 1920 Set of 3 point internal micrometers

DIN  
863-4

## Specification

- DIN 863-4
- Reading: 0.001 mm\*
- Reading: 0.005 mm
- Reading parts are satin chrome finished
- Pitch 0.5 mm
- Carbide tipped measuring pins from measuring range 12 mm
- Ratchet stop
- From measuring range 12 mm for through and blind holes
- Certificate for ring and device

## Shipment

- Plastic case
- Incl. setting ring

⊠	⊠	Measuring range mm	Thimble mm	Setting ring dia. mm	Ref. No.	List price Euro
▪		6 - 12	16	8 + 10	1920 574*	1,040.00
▪		12 - 20	16	16	1920 576*	730.00
▪		20 - 50	25	25 + 40	1920 578	1,800.00
▪		50 - 100	25	60 + 85	1920 580	2,150.00

## 1920 Measuring depth extensions for 3 point internal micrometers 1920-1921



## Specification

- Suitable for devices 1920 and 1921

⊠	⊠	For measuring range mm	Length mm	Ref. No.	List price Euro
		6 - 12	75	1920 910	85.00
		12 - 20	75	1920 914	90.00
		20 - 50	150	1920 920	95.00
		50 - 100	150	1920 924	115.00

Jean Louis MENEGON - Votre représentant et Conseiller- Tél. : 06 76 08 96 83

E-mail: [jlouismenegon@aol.com](mailto:jlouismenegon@aol.com) - web: [www.menegon-metrologie.com](http://www.menegon-metrologie.com)



# HELIOS • PREISSER

## 0907 DIGI-MET® 2/3 point internal micrometers



Inclusive!



### Specification

- DIN 863-4
- Reading: 0.001 mm / .00005 inch
- Protection class IP67
- LCD display
- Certificate for setting ring and internal micrometer
- Ratchet stop
- For through holes
- From measuring range 12.5 mm for through and blind holes
- From measuring range 12.5 mm with carbide tipped measuring faces

### Electronic functions

- ON/OFF switch
- Zero setting at any position
- mm/inch conversion
- Data output: 2 versions to choose (see table)
  - serial interface RS 232
  - Power
  - wireless data transfer via bluetooth
- Max/Min value memory
- Hold Function
- PRESET Function (setting a numerical value)
- Tolerance function

### Shipment

- Wooden case
- With setting ring

		Measuring range mm	Meas. depth mm	Accuracy µm	Setting ring dia. mm	Ref. No. without Bluetooth	List price Euro	Ref. No. Bluetooth	List price Euro
<b>DIGI-MET 2 Point internal micrometer</b>									
▪		2 - 2.5	9	4	2.5	0907 701	1,422.00	0907 801	1,497.00
▪		2.5 - 3	9	4	2.5	0907 702	1,422.00	0907 802	1,497.00
▪		3 - 4	12	4	4.0	0907 703	1,422.00	0907 803	1,497.00
▪		4 - 5	18	4	4.0	0907 704	1,422.00	0907 804	1,497.00
▪		5 - 6	18	4	5.0	0907 705	1,422.00	0907 805	1,497.00
<b>DIGI-MET 3 Point internal micrometer</b>									
▪		6 - 8	58	4	8.0	0907 706	983.00	0907 806	1,058.00
▪		8 - 10	58	4	8.0	0907 707	983.00	0907 807	1,058.00
▪		10 - 12.5	58	4	12.5	0907 708	995.00	0907 808	1,070.00
▪		12.5 - 16	62	4	12.5	0907 709	1,009.00	0907 809	1,084.00
▪		16 - 20	62	4	20.0	0907 710	1,009.00	0907 810	1,084.00
▪		20 - 25	66	4	20.0	0907 711	1,212.00	0907 811	1,287.00
▪		25 - 35	66	4	35.0	0907 712	1,393.00	0907 812	1,468.00
▪		35 - 50	80	4	35.0	0907 713	1,448.00	0907 813	1,523.00
▪		50 - 65	80	5	65.0	0907 714	1,611.00	0907 814	1,686.00
▪		65 - 80	80	5	65.0	0907 715	1,611.00	0907 815	1,686.00
▪		80 - 100	100	5	80.0	0907 716	1,698.00	0907 816	1,773.00
▪		100 - 125	115	6	125.0	0907 717	1,770.00	0907 817	1,845.00
▪		125 - 150	115	6	125.0	0907 718	1,825.00	0907 818	1,900.00
▪		150 - 175	115	7	175.0	0907 719	1,996.00	0907 819	2,071.00
▪		175 - 200	115	7	175.0	0907 720	2,123.00	0907 820	2,198.00
▪		200 - 225	118	8	225.0	0907 721	2,573.00	0907 821	2,648.00
▪		225 - 250	118	8	225.0	0907 722	2,835.00	0907 822	2,910.00
▪		250 - 275	118	9	275.0	0907 723	2,939.00	0907 823	3,014.00
▪		275 - 300	118	9	275.0	0907 724	3,209.00	0907 824	3,284.00

Jean Louis MENEGON - Votre représentant et Conseiller- Tél. : 06 76 08 96 83

E-mail: [jlouismenegon@aol.com](mailto:jlouismenegon@aol.com) - web: [www.menegon-metrologie.com](http://www.menegon-metrologie.com)

Ref. No. List price  
Euro

Battery, 3V-Lithium, CR 2032	0220 704	3.60
USB-Keyboard interface cable RS 232 Power	0997 774	283.00
Bluetooth receiver	1998 750	125.00





## 0907 Set of DIGI-MET® 2/3 point internal micrometers



## Specification



- DIN 863-4
- Reading: 0.001 mm / .00005 inch
- Protection class IP67
- LCD display
- Certificate for setting ring and internal micrometers
- Ratchet stop
- For through holes
- From measuring range 12.5 mm for through and blind holes
- From measuring range 12.5 mm with carbide tipped measuring faces

## Electronic functions

- ON/OFF switch
- Zero setting at any position
- mm/inch conversion
- Data output: 2 versions to choose (see table)
  - serial interface RS 232
  - Power
  - wireless data transfer via bluetooth
- Max/Min value memory
- Hold Function
- PRESET Function (setting a numerical value)
- Tolerance function

## Shipment

- Wooden case
- With setting rings

Icon	Icon	Measuring range mm	Setting ring dia. mm	Ref. No. without Bluetooth	List price Euro	Ref. No. Bluetooth	List price Euro
<b>2 Point internal micrometer</b>							
▪		2 - 6	2.5 / 4.0 / 5.0	0907 751	3,408.00	0907 851	3,483.00
<b>3 Point internal micrometer</b>							
▪		6 - 10	8.0	0907 753	1,359.00	0907 853	1,434.00
▪		10 - 20	12.5 / 20.0	0907 755	1,644.00	0907 855	1,719.00
▪		20 - 50	20.0 / 35.0	0907 757	2,266.00	0907 857	2,341.00
▪		50 - 100	65.0 / 80.0	0907 759	2,519.00	0907 859	2,594.00
▪		100 - 150	125.0	0907 761	2,114.00	0907 861	2,189.00
▪		150 - 200	125.0	0907 763	2,826.00	0907 863	2,901.00
▪		100 - 200	125.0 / 175.0	0907 775	4,437.00	0907 875	4,512.00

Jean Louis MENEGON - Votre représentant et Conseiller- Tél. : 06 76 08 96 83

E-mail: [jlouismenegon@aol.com](mailto:jlouismenegon@aol.com) - web: [www.menegon-metrologie.com](http://www.menegon-metrologie.com)

	Ref. No.	List price Euro
Battery, 3V-Lithium, CR 2032	0220 704	3.60
USB-Keyboard interface cable RS 232 Power	0997 774	283.00
Bluetooth receiver	1998 750	125.00

## Measuring depth extensions for 2/3 point internal micrometers 0907-0908



## Specification

- Suitable for gauges 0907 and 0908

Icon	Icon	Measuring range mm	Length mm	Ref. No.	List price Euro
▪		6 - 10	63	0909 506	78.00
▪		10 - 12.5	76	0909 508	78.00
▪		12.5 - 20	100	0909 509	78.00
▪		20 - 50	150	0909 511	114.00
▪		50 - 300	150	0909 514	134.00



# HELIOS • PREISSER

## 0908 DIGI-MET® 2/3 point internal micrometer



Inclusive!

### Specification

- DIN 863-4
- Reading: 0.001 mm / .00005 inch
- Protection class IP67
- With pistol grip
- From measuring range 12.5 mm with carbide tipped measuring faces
- Rotateable LCD display
- For through holes
- Certificate for setting ring and micrometer
- From measuring range 12.5 mm for through and blind holes

### Shipment

- Wooden case
- With setting ring



### Electronic functions

- ON/OFF switch
- Zero setting at any position
- mm/inch conversion
- Data output: 2 versions to choose (see table)
  - serial interface RS 232
  - Power
  - wireless data transfer via bluetooth
- MAX/MIN value memory
- Hold Function
- PRESET Function (setting a numerical value)
- Tolerance function

Icon	Measuring range mm	Meas. depth mm	Accuracy µm	Setting ring dia. mm	Ref. No. without Bluetooth	List price Euro	Ref. No. Bluetooth	List price Euro
<b>DIGI-MET 2 Point instant internal micrometer</b>								
▪	2 - 2.5	9	4	2.5	0908 701	1,640.00	0908 801	1,715.00
▪	2.5 - 3	9	4	2.5	0908 702	1,640.00	0908 802	1,715.00
▪	3 - 4	12	4	4.0	0908 703	1,640.00	0908 803	1,715.00
▪	4 - 5	18	4	4.0	0908 704	1,640.00	0908 804	1,715.00
▪	5 - 6	18	4	5.0	0908 705	1,640.00	0908 805	1,715.00
<b>DIGI-MET 3 Point instant internal micrometer</b>								
▪	6 - 8	58	4	8.0	0908 706	1,160.00	0908 806	1,235.00
▪	8 - 10	58	4	8.0	0908 707	1,134.00	0908 807	1,209.00
▪	10 - 12.5	58	4	12.5	0908 708	1,197.00	0908 808	1,272.00
▪	12.5 - 16	62	4	12.5	0908 709	1,214.00	0908 809	1,289.00
▪	16 - 20	62	4	20.0	0908 710	1,287.00	0908 810	1,362.00
▪	20 - 25	66	4	20.0	0908 711	1,374.00	0908 811	1,449.00
▪	25 - 35	66	4	35.0	0908 712	1,491.00	0908 812	1,566.00
▪	35 - 50	80	4	35.0	0908 713	1,523.00	0908 813	1,598.00
▪	50 - 65	80	5	65.0	0908 714	1,568.00	0908 814	1,643.00
▪	65 - 80	80	5	65.0	0908 715	1,568.00	0908 815	1,643.00
▪	80 - 100	100	5	80.0	0908 716	1,672.00	0908 816	1,747.00
▪	100 - 125	115	6	125.0	0908 717	1,749.00	0908 817	1,824.00
▪	125 - 150	115	6	125.0	0908 718	1,855.00	0908 818	1,930.00
▪	150 - 175	115	7	175.0	0908 719	1,962.00	0908 819	2,037.00
▪	175 - 200	115	7	175.0	0908 720	2,051.00	0908 820	2,126.00
▪	200 - 225	118	8	225.0	0908 721	2,698.00	0908 821	2,773.00
▪	225 - 250	118	8	225.0	0908 722	2,976.00	0908 822	3,051.00
▪	250 - 275	118	9	275.0	0908 723	3,084.00	0908 823	3,159.00
▪	275 - 300	118	9	275.0	0908 724	3,404.00	0908 824	3,479.00

Jean Louis MENEGON - Votre représentant et Conseiller- Tél. : 06 76 08 96 83

E-mail: [jlouismenegon@aol.com](mailto:jlouismenegon@aol.com) - web: [www.menegon-metrologie.com](http://www.menegon-metrologie.com)

Ref. No. List price Euro

Battery, 3V-Lithium, CR 2032	0220 704	3.60
USB-Keyboard interface cable RS 232 Power	0997 774	283.00
Bluetooth receiver	1998 750	125.00



## 0908 Set of DIGI-MET® 2/3 point internal micrometers



### Specification



- DIN 863-4
- Reading: 0.001 mm / .00005 inch
- Protection class IP67
- With pistol grip
- From measuring range 12.5 mm with carbide tipped measuring faces
- Rotateable LCD display
- Certificate for setting ring and micrometer
- For through holes
- From measuring range 12.5 mm for through and blind holes

### Electronic functions

- ON/OFF switch
- Zero setting at any position
- mm/inch conversion
- Data output: 2 versions to choose (see table) - serial interface RS 232 Power - wireless data transfer via bluetooth
- Max/Min value memory
- Hold Function
- PRESET Function (setting a numerical value)
- Tolerance function

### Shipment

- Wooden case
- With setting rings
- Calibration according to table

Icon	Icon	Measuring range		Setting ring dia. mm	Ref. No. without Bluetooth	List price Euro	Ref.No. Bluetooth	List price Euro
		mm	inch					
<b>2 Point instant internal micrometer</b>								
▪		2 - 6	.080 - .250	2.5 / 4.0 / 5.0	0908 751	3,749.00	0908 851	3,824.00
<b>3 Point instant internal micrometer</b>								
▪		6 - 10	1/4 - 3/8	8.0	0908 753	1,407.00	0908 853	1,482.00
▪		10 - 20	3/8 - 3/4	12.5 / 20.0	0908 755	1,662.00	0908 855	1,737.00
▪		20 - 50	3/4 - 2	20.0 / 35.0	0908 757	2,177.00	0908 857	2,252.00
▪		20 - 100	3/4 - 4	20.0 / 35.0 / 65.0 / 80.0	0908 773	3,613.00	0908 873	3,688.00
▪		50 - 100	2 - 4	65.0 / 80.0	0908 759	2,438.00	0908 859	2,513.00
▪		100 - 150	4 - 6	125.0	0908 761	2,177.00	0908 861	2,252.00
▪		150 - 200	6 - 8	175.0	0908 763	2,909.00	0908 863	2,984.00
▪		100 - 200	4 - 8	125.0 / 175.0	0908 775	4,607.00	0908 875	4,682.00

Jean Louis MENEGON - Votre représentant et Conseiller- Tél. : 06 76 08 96 83

E-mail: [jlouismenegon@aol.com](mailto:jlouismenegon@aol.com) - web: [www.menegon-metrologie.com](http://www.menegon-metrologie.com)

	Ref. No.	List price Euro
Battery, 3V-Lithium, CR 2032	0220 704	3.60
USB-Keyboard interface cable RS 232 Power	0997 774	283.00
Bluetooth receiver	1998 750	125.00

## Measuring depth extensions for 2/3 point internal micrometers 0907-0908



### Specification

- Suitable for all internal micrometers from series 0907 and 0908

Icon	Icon	Measuring range		Length mm	Ref. No.	List price Euro
		mm				
▪		6	- 10	63	0909 506	78.00
▪		10	- 12.5	76	0909 508	78.00
▪		12.5	- 20	100	0909 509	78.00
▪		20	- 50	150	0909 511	114.00
▪		50	- 300	150	0909 514	134.00



# HELIOS • PREISSER

## 0882 Depth micrometers



### Specification

- DIN 863-2
- Reading: 0.01 mm
- Reading parts are satin chrome finished
- Locking ring
- Friction coupling
- With interchangeable steel measuring inserts dia. 4 mm
- Hardened measuring faces

### Shipment

- Wooden case

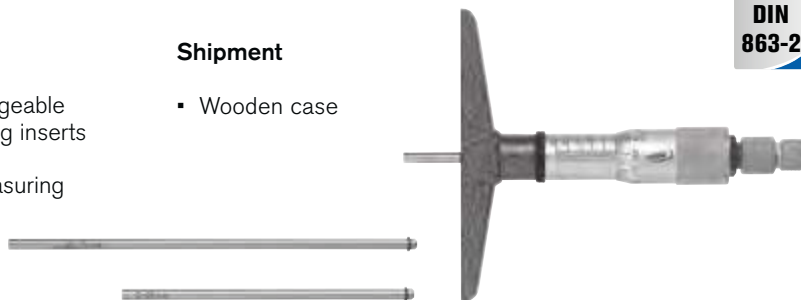

DIN 863-2

		Measuring range mm	Length of base mm	Thimble dia. mm	No. of measuring inserts	Pitch mm	Ref. No.	List price Euro
<b>Measuring faces dia. 0.8, length 8.5 mm</b>								
		0 - 50	50	20	2	0.5	0882 300	253.00
		0 - 75	50	20	3	0.5	0882 301	275.00
		0 - 100	100	20	4	0.5	0882 303	302.00
		0 - 150	100	20	6	0.5	0882 304	354.00
		0 - 300	100	20	12	0.5	0882 306	570.00

2

## 0886 Micrometers heads



0886 503



0886 507

### Specification

- DIN 863-2
- Reading: 0.01 mm
- Reading parts are satin chrome finished
- Carbide measuring faces

### Shipment

- Plastic case

DIN 863-2

		Measuring range mm	Spindle dia. mm	Thimble dia. mm	Specification	Ref. No.	List price Euro
		0 - 6.5	3.5	9.5	without ratchet stop	0886 503	22.50
		0 - 13	6.5	13.5	without ratchet stop	0886 505	26.00
		0 - 25	6.5	18	with ratchet stop	0886 507	22.50
		0 - 25	8.0	18	with ratchet stop, non-rotating spindle	0886 513	40.00

Jean Louis MENEGON - Votre représentant et Conseiller- Tél. : 06 76 08 96 83

E-mail: [jlouismenegon@aol.com](mailto:jlouismenegon@aol.com) - web: [www.menegon-metrologie.com](http://www.menegon-metrologie.com)



## WE WILL **BACK** YOU UP

Our service is only useful to you if it's there when you need it, which is why we take such care to think everything out in advance... The result is a presence that scores with expertise: we have more than 5,000 specialist dealers around the globe ready to support professional users of our products.

We transfer knowledge to our dealers with appropriate training and we are happy to assist in finding joint solutions to measurement problems. This enables us to maintain our short routes based on partnership so that our products can be used most effectively.

Having a leading brand also means being able to meet special requirements. That's why the calibration certificate is simply part of the service and is in many cases already included. The benefits are obvious: our users can get started right away using ur calibrated measurement and testing equipment to comply with a diverse range of guidelines, standards and laws.



### **3. CHAPTER DIAL GAUGES AND INDICATING INSTRUMENTS**

118	Indicators
124	Dial gauges
129	Precision indicators
130	Accessories for dial gauges and precision indicators
132	Measuring inserts for dial gauges
135	Dial test indicators
136	Depth gauges, depth measuring base
137	Dial thickness gauges
139	Internal and external caliper gauges
143	Digital internal precision bore gauge
144	Analogue internal precision bore gauges
146	Crankshaft gauges
146	Length measuring instruments for external incisions
147	Length measuring instruments for internal incisions
148	Universal comparator gauge
151	Comparator gauge UHRTAST
157	Magnetic measuring stands
161	Measuring tables
163	Bench centres
168	Shaft measuring instruments



## 1722 / 1723 / 1724 DIGI-MET® Indicators

for static measurements



1722 502



1723 502



1724 502

### Specification

- Housing Ø 60 mm
- Replacement probe tip M2.5
- Protection class IP52
- Clamping shank Ø 8 mm
- LCD display with 12 mm high numerals
- Measuring force 0.5 - 1 N
- Accuracy according to factory standard

### Electronic functions

- ON/OFF switch
- **QuickStart** Electronic
- **QuickLock** Function
- Zero setting at any position
- Reversal of counting direction
- mm/inch conversion
- Individual buttons can be locked
- Variable data output RS 232 + Digimatic + USB
- PRESET Function (setting a numerical value)

### Shipment

- Cardboard box

⏏	🔒	Measuring range		Reading		Error limit µm	Ref. No.	List price Euro
		mm	inch	mm	inch			
		12.5	0.5	0.01	.0005	0.020	1722 502	133.00
		12.5	0.5	0.005	.0001	0.015	1723 502	167.00
		12.5	0.5	0.001	.00005	0.005	1724 502	273.00

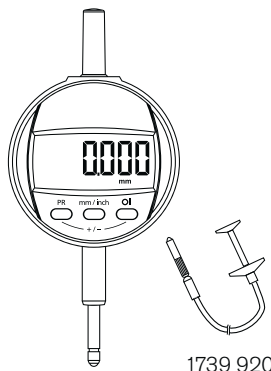

1739 920

### Accessories

	Ref. No.	List price Euro
Battery, 3V-Lithium, CR 2032	0220 704	3.60
Cable for USB incl. software	1998 720	66.00
Cable for RS 232	1997 501	46.20
Cable for Digimatic	1998 501	59.00
Cable release (12.5 mm)	1739 920	13.80

Jean Louis MENEGON - Votre représentant et Conseiller- Tél. : 06 76 08 96 83

E-mail: [jlouismenegon@aol.com](mailto:jlouismenegon@aol.com) - web: [www.menegon-metrologie.com](http://www.menegon-metrologie.com)



## 1726 / 1728 DIGI-MET® Indicators

for static measurements



1728 502



1726 502

**Jean Louis MENEGON** - Votre représentant et Conseiller- Tél. : **06 76 08 96 83**  
 E-mail: [jlouismenegon@aol.com](mailto:jlouismenegon@aol.com) - web: [www.menegon-metrologie.com](http://www.menegon-metrologie.com)

### Specification

- Aluminium housing
- Hardened stainless steel spindle
- Outer ring (Bezel) Ø 60 mm
- Replacement probe tip M2.5
- Protection class IP42
- Clamping shank Ø 8 mm
- Display unit can be rotated through 280°
- LCD display with 11 mm high numerals
- Factory standard

### Shipment

- Cardboard box

### Electronic functions

- ON/OFF switch
- QuickStart** Electronic
- QuickLock** Function
- Zero setting at any position
- mm/inch conversion
- Absolute function (display can be set to zero without losing the Preset value)
- Tolerance function
- Reversal of counting direction
- Factor input
- Individual buttons can be locked
- Variable data output RS 232 + Digimatic + USB
- PRESET Function (setting a numerical value)

	Measuring range	Reading	Error limit		Ref. No.	List price Euro	
			mm	inch			mm
<b>Reading 0.01 mm</b>							
	12.5	.5	0.01	20	10	1728 502	267.00
	25.0	1.0	0.01	20	10	1728 506	340.00
	50.0	2.0	0.01	20	10	1728 510	554.00
	100.0	4.0	0.01	20	10	1728 514	709.00
<b>Reading 0.001 mm</b>							
	12.5	.5	0.001*	4	2	1726 502	319.00
	25.0	1.0	0.001*	4	2	1726 506	351.00
	50.0	2.0	0.001*	7	2	1726 510	618.00
	100.0	4.0	0.001*	8	2	1726 514	765.00

\* Reading switchable: 0.0005 / 0.001 / 0.002 / 0.005 / 0.010 mm

\*\* Partial span= 25 steps by step value 0.0005 mm

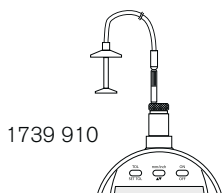

1739 910

Accessories	Ref. No.	List price Euro
Battery, 3V-Lithium, CR 2450	1998 770	5.50
Cable for USB incl. software	1998 720	66.00
Cable for RS 232	1997 501	46.20
Cable for Digimatic	1998 501	59.00
Cable release (12.5 + 25 mm)	1739 910	37.00





# 1730 / 1732 DIGI-MET® Indicators

for static measurements



1730 502



1730 506

Jean-Louis MENEGON - Votre représentant et Conseiller - Tél. : 06 76 08 96 83  
E-mail: [jlouismenegon@aol.com](mailto:jlouismenegon@aol.com) - web: [www.menegon-metrologie.com](http://www.menegon-metrologie.com)

### Specification

- Aluminium housing
- Hardened stainless steel spindle
- Outer ring (Bezel) Ø 60 mm
- Replacement probe tip M2.5
- Protection class IP54
- Clamping shank Ø 8 mm
- Display unit can be rotated through 280°
- LCD display with 11 mm high numerals
- Factory standard

### Shipment

- Cardboard box

### Electronic functions

- ON/OFF switch
- QuickStart Electronic
- QuickLock Function
- Zero setting at any position
- mm/inch conversion
- Absolute function (display can be set to zero without losing the Preset value)
- Tolerance function
- Reversal of counting direction
- Factor input
- Individual buttons can be locked
- Variable data output RS 232 + Digimatic + USB
- PRESET Function (setting a numerical value)

Marked *	Marked *	Measuring range		Reading mm	Error limit		Ref. No.	List price Euro
		mm	inch		total span µm	partial span** µm		
		12.5	.5	0.01	20	-	1732 502	298.00
		25.0	1.0	0.01	20	-	1732 506	376.00
		12.5	.5	0.001*	4	2	1730 502	353.00
		25.0	1.0	0.001*	4	2	1730 506	398.00

\* Reading switchable: 0.0005 / 0.001 / 0.002 / 0.005 / 0.010 mm  
\*\* Partial span= 25 steps by step value 0.0005 mm



1739 910

Accessories	Ref. No.	List price Euro
Battery, 3V-Lithium, CR 2450	1998 770	5.50
Cable for USB incl. software	1998 720	66.00
Cable for RS 232	1997 501	46.20
Cable for Digimatic	1998 501	59.00
Cable release (12.5 + 25 mm)	1739 910	37.00



# HELIOS • PREISSER

## 1734 DIGI-MET® indicators with combined analogue / digital display

for static and dynamic measurements



1734 502



1734 506

**Jean Louis MENEGON** - Votre représentant et Conseiller- Tél. : **06 76 08 96 83**  
 E-mail: [jlouismenegon@aol.com](mailto:jlouismenegon@aol.com) - web: [www.menegon-metrologie.com](http://www.menegon-metrologie.com)

### Specification

- Aluminium housing
- Hardened stainless steel spindle
- Outer ring (Bezel) Ø 60 mm
- Replacement probe tip M 2.5
- Protection class IP42
- Clamping shank Ø 8 mm

- Display unit can be rotated through 280°
- LCD display with 8.5 mm high numerals
- Factory standard

### Shipment

- Cardboard box

### Electronic functions

- ON/OFF switch
- QuickStart** Electronic
- QuickLock** Function
- Zero setting at any position
- mm/inch conversion
- Absolute function (display can be set to zero without losing the Preset value)
- Tolerance function
- MAX/MIN function
- TIR (MAX-MIN) function
- Reversal of counting direction
- Factor input
- Individual buttons can be locked
- Variable data output RS 232 + Digimatic + USB
- PRESET Function (setting a numerical value)

		Measuring range		Reading mm	Error limit		Ref. No.	List price Euro
		mm	inch		total span µm	partial span** µm		
		12.5	.5	0.001*	0.005	.0002	1734 502	367.00
		25.0	1.0	0.001*	0.005	.0002	1734 506	421.00

\* Reading switchable: 0.0005 / 0.001 / 0.002 / 0.005 / 0.010 mm

\*\* Partial span= 25 steps by step value 0.0005 mm



1739 910

Accessories	Ref. No.	List price Euro
Battery, 3V-Lithium, CR 2450	1998 770	5.50
Cable for USB incl. software	1998 720	66.00
Cable for RS 232	1997 501	46.20
Cable for Digimatic	1998 501	59.00
Cable release (12.5 + 25 mm)	1739 910	37.00



# 1734 DIGI-MET® Indicators with combined analogue / digital display



for comparator gauge

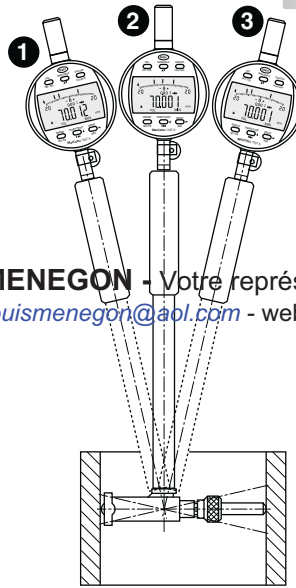

Jean Louis MENEGON - Votre représentant et Conseiller- Tél. : 06 76 08 96 83  
E-mail: [jlouismenegon@aol.com](mailto:jlouismenegon@aol.com) - web: [www.menegon-metrologie.com](http://www.menegon-metrologie.com)

### Application

The turning point can be determined automatically in measurements with a 2 point internal measuring device through commuting. The actual value is detected and stored by the MIN function and appears on the display.

### Specification

- Aluminium housing
- Outer ring (Bezel) Ø 60 mm
- Replacement probe tip M 2.5
- Protection class IP42
- Clamping shank Ø 8 mm
- Display unit can be rotated through 280°
- LCD display with 8.5 mm high numerals
- Factory standard

### Electronic functions

- ON/OFF switch
- QuickStart Electronic
- QuickLock Function
- Zero setting at any position
- mm/inch conversion
- Absolute function (display can be set to zero without losing the Preset value)
- Tolerance function
- MAX/MIN function

### Shipment

- Cardboard box

Symbol	Symbol	Measuring range		Reading	Error limit		Ref. No.	List price
		mm	inch		mm	total span µm		
		12.5	.5	0.001*	4	2	1734 522	475.00

\* Reading switchable: 0.0005 / 0.001 / 0.002 / 0.005 / 0.010 mm

\*\* Partial span= 25 steps by step value 0.0005 mm



1739 910

Accessories	Ref. No.	List price
Battery, 3V-Lithium, CR 2450	1998 770	5.50
Cable for USB incl. software	1998 720	66.00
Cable for RS 232	1997 501	46.20
Cable for Digimatic	1998 501	59.00
Cable release (12.5 + 25 mm)	1739 910	37.00



# HELIOS • PREISSER

## 0691 DIGI-MET® Indicators



### Specification

- Aluminium housing
- Outer ring (Bezel) Ø 60 mm
- Replacement probe tip M 2.5
- Protection class IP51
- Water and coolant resistant
- Clamping shank Ø 8 mm
- Display unit can be rotated through 270°
- LCD display with 11 mm high numerals
- Factory standard

### Electronic functions

- ON/OFF switch
- Zero setting at any position
- mm/inch-conversion
- Data output RS 232 Proximity + RS 232 Power (USB-keyboard interface cable, see page 270)
- PRESET function (setting a numerical value)

### \* Additional functions models 0691 751 + 0691 753

- Tolerances (visual indications via LEDs)
- MAX/MIN function
- TIR (MAX-MIN) function
- Factor input

### Shipment

- Cardboard box



**Jean Louis MENEGON** - Votre représentant et Conseiller- Tél. : 06 76 08 96 83  
E-mail: [jlouismenegon@aol.com](mailto:jlouismenegon@aol.com) - web: [www.menegon-metrologie.com](http://www.menegon-metrologie.com)

	Measuring range	Measuring range		Reading		Error limit µm	Ref. No.	List price Euro
		mm	inch	mm	inch			
<b>Reading 0.01 mm</b>								
	12.5	.5	0.01	.0005	10	0691 731	349.00	
	25.0	1.0	0.01	.0005	10	0691 733	400.00	
	50.0	2.0	0.01	.0005	20	0691 735	871.00	
	100.0	4.0	0.01	.0005	20	0691 737	982.00	
<b>Reading 0.001 mm</b>								
	12.5	.5	0.001	.00005	4	0691 741	431.00	
	25.0	1.0	0.001	.00005	5	0691 743	473.00	
	50.0	2.0	0.001	.00005	7	0691 745	965.00	
	100.0	4.0	0.001	.00005	8	0691 747	1,115.00	
<b>Reading 0.001 mm, with additional functions*</b>								
	12.5	.5	0.001	.00005	3	0691 751**	501.00	
	25.0	1.0	0.001	.00005	4	0691 753**	554.00	



## 0701 Small dial gauges with lightweight plastic housing



**DIN  
878**



### Specification

- Lightweight housing made of polyamide
- Measuring spindle is made of stainless steel
- Replacement probe tip M 2.5
- Clamping shank Ø 8 mm
- DIN 878

### Shipment

- Case

**Jean Louis MENEGON** - Votre représentant et Conseiller- Tél. : 06 76 08 96 83

E-mail: [jlouismenegon@aol.com](mailto:jlouismenegon@aol.com) - web: [www.menegon-metrologie.com](http://www.menegon-metrologie.com)

		Measuring range mm	Reading mm	Range per revolution mm	Outer ring (Bezel) dia. mm	Ref. No.	List price Euro
<b>Small dial gauge</b>							
		5	0.01	0.5	40	0701 101	37.10
<b>Shockproof small dial gauge</b>							
		5	0.01	0.5	40	0701 102	45.60

## 0708 Small dial gauges



**DIN  
878**



0708 102



0708 101

### Specification

- Metal housing
- Measuring spindle is made of stainless steel
- Replacement probe tip M 2.5
- Clamping shank Ø 8 mm
- With a revolution counter
- DIN 878

### Shipment

- Case

		Measuring range mm	Reading mm	Range per revolution mm	Outer ring (Bezel) dia. mm	Ref. No.	List price Euro
<b>Small dial gauge</b>							
		10	0.01	0.5	40	0708 101	79.00
		5	0.01	0.5	40	0708 102	50.00
		3	0.01	0.5	32	0708 103	60.00
		3	0.01	0.5	40	0708 104	41.60
<b>Shockproof small dial gauge</b>							
		3	0.01	0.5	40	0708 105	50.00
		5	0.01	0.5	40	0708 106	67.00



0701 Dial gauges



DIN 878



0701 110



0701 106

Specification

- Measuring spindle is made of stainless steel
- Replacement probe tip M 2.5
- Clamping shank Ø 8 mm
- DIN 878

Shipment

- Case

		Measuring range mm	Reading mm	Range per revolution mm	Outer ring (Bezel) dia. mm	Ref. No.	List price Euro
		<b>Dial gauge, plastic housing</b>					
		10	0.01	1	58	0701 103	20.50
		<b>Dial gauge, metal housing</b>					
		10	0.01	1	58	0701 110	36.70
		<b>Shockproof dial gauge, injection-moulded housing</b>					
		10	0.01	1	58	0701 106	21.60
		<b>Shockproof dial gauge, metal housing</b>					
		10	0.01	1	58	0701 111	42.30

3

0703 Dial gauges with extended measuring range



Jean Louis MENEGON - Votre représentant et Conseiller- Tél. : 06 76 08 96 83  
E-mail: [jlouismenegon@aol.com](mailto:jlouismenegon@aol.com) - web: [www.menegon-metrologie.com](http://www.menegon-metrologie.com)



0703 101

Specification

- Metal housing
- Measuring spindle is made of stainless steel
- Replacement probe tip M 2.5
- Clamping shank Ø 8 mm
- With a concentric pointer
- Factory standard

Shipment

- Case

		Measuring range mm	Reading mm	Range per revolution mm	Outer ring (Bezel) dia. mm	Ref. No.	List price Euro
		30	0.01	1	58	0703 101	90.00
		50	0.01	1	58	0703 104	125.00
		80	0.01	1	58	0703 107	250.00



## 0704 Shockproof dial gauges



DIN  
878



### Specification

- Metal housing
- Measuring spindle is made of stainless steel
- Replacement probe tip M 2.5
- Clamping shank Ø 8 mm
- Shockproof

### Shipment

- Case

Jean Louis MENEGON - Votre représentant et Conseiller- Tél. : 06 76 08 96 83

E-mail: [jlouismenegon@aol.com](mailto:jlouismenegon@aol.com) - web: [www.menegon-metrologie.com](http://www.menegon-metrologie.com)

		Measuring range mm	Reading mm	Range per revolution mm	Outer ring (Bezel) dia. mm	Ref. No.	List price Euro
<b>Revolution counter: DIN 878</b>							
		10	0.01	1	58	0704 105	64.00
<b>With fine adjustment of the pointer: DIN 878</b>							
		10	0.01	1	58	0704 106	79.00
<b>Concentric pointer: Factory standard</b>							
		30	0.01	1	58	0704 109	103.00
		50	0.01	1	58	0704 110	133.00

## 0707 Water and oil proof dial gauges



DIN  
878



### Specification

- Metal housing, water and oil proof
- Protection class IP67
- Measuring spindle is made of stainless steel
- Replacement probe tip M 2.5
- Clamping shank Ø 8 mm
- Rubber bellows
- Shockproof
- Outer ring (Bezel) can be rotated through 360°
- DIN 878

### Shipment

- Case

		Measuring range mm	Reading mm	Range per revolution mm	Outer ring (Bezel) dia. mm	Ref. No.	List price Euro
		3	0.01	0.5	44.6	0707 101	113.00
		10	0.01	1	61.5	0707 102	97.00



## 0700 Dial gauges, graduation 0.1 mm



### Specification

- Metal housing
- Measuring spindle is made of stainless steel
- Replacement probe tip M 2.5
- Clamping shank Ø 8 mm
- Factory standard

### Shipment

- Case

		Measuring range mm	Reading mm	Range per revolution mm	Outer ring (Bezel) dia. mm	Ref. No.	List price Euro
		10	0.1	10	40	0700 100	55.00
		5	0.1	5	40	0700 101	55.00
		10	0.1	10	58	0700 102	42.10
<b>Straight line revolution counte</b>							
		30	0.1	10	58	0700 104	48.30

## 0702 Dial gauge with concentric mm display



DIN 878



### Specification

- Metal housing
- Measuring spindle is made of stainless steel
- Replacement probe tip M 2.5
- Clamping shank Ø 8 mm
- With a concentric pointer
- DIN 878

### Shipment

- Case

**Jean Louis MENEGON** - Votre représentant et Conseiller- Tél. : 06 76 08 96 83  
E-mail: [jlouismenegon@aol.com](mailto:jlouismenegon@aol.com) - web: [www.menegon-metrologie.com](http://www.menegon-metrologie.com)

		Measuring range mm	Reading mm	Range per revolution mm	Outer ring (Bezel) dia. mm	Ref. No.	List price Euro
		10	0.01	1	58	0702 106	56.00





### 0705 Precision dial gauges



#### Specification

- Metal housing
- Measuring spindle is made of stainless steel
- Replacement probe tip M 2.5
- Clamping shank Ø 8 mm
- With revolution counter
- Factory standard

#### Shipment

- Case

⌘	☒	Measuring range mm	Reading mm	Range per revolution mm	Outer ring (Bezel) dia. mm	Ref. No.	List price Euro
		1	0.001	0.2	40	0705 102	99.00
		1	0.001	0.2	58	0705 104	99.00
		5	0.001	0.2	58	0705 105	103.00
<b>Precision shockproof dial gauge</b>							
		1	0.001	0.2	40	0705 107	105.00
		5	0.001	0.2	58	0705 109	128.00

### 0706 Error free, shockproof dial gauge



DIN 878



#### Specification

- Metal housing
- Measuring spindle is made of stainless steel
- Replacement probe tip M 2.5
- Clamping shank Ø 8 mm
- Free lift 1 mm
- DIN 878

#### Shipment

- Case

**Jean Louis MENEGON** - Votre représentant et Conseiller- Tél. : 06 76 08 96 83  
 E-mail: [jlouismenegon@aol.com](mailto:jlouismenegon@aol.com) - web: [www.menegon-metrologie.com](http://www.menegon-metrologie.com)

⌘	☒	Measuring range mm	Reading mm	Free lift mm	Outer ring (Bezel) dia. mm	Ref. No.	List price Euro
		0.8	0.01	1	58	0706 102	64.00



0709 Dial gauges with reverse action plunger



Specification

- Metal housing
- Measuring spindle is made of stainless steel
- Replacement probe tip M 2.5
- Clamping shank Ø 8 mm
- Factory standard

Shipment

- Case

		Measuring range mm	Reading mm	Range per revolution mm	Outer ring (Bezel) dia. mm	Ref. No.	List price Euro
		3	0.01	0.5	40	0709 101	95.00
		5	0.01	1	58	0709 108	113.00

3

0712 Dial comparator gauge MICROTAST



DIN 879



0712 121



0712 124

Specification

- Measuring spindle is made of hardened stainless steel
- Longer measuring spindle
- Replacement probe tip M 2.5
- Clamping shank Ø 8 mm
- Tolerance markers
- Shockproof
- Fine adjustment
- DIN 879

Shipment

- Case

Jean Louis MENEGON - Votre représentant et Conseiller- Tél. : 06 76 08 96 83

E-mail: [jlouismenegon@aol.com](mailto:jlouismenegon@aol.com) - web: [www.menegon-metrologie.com](http://www.menegon-metrologie.com)

		Measuring range mm	Reading mm	Dial reading	Overtravel mm	Ref. No.	List price Euro
		0.5	0.01	25-0-25	2.5	0712 121	143.00
		0.1	0.001	50-0-50	3.0	0712 124	175.00



### 0710 Magnetic back



#### Specification

- For dial gauges with outer ring (Bezel) Ø 58 mm
- Allows dial gauges to be used without a holder or a stand
- Magnetic force 220 N
- Cannot be used in conjunction with dial gauges 0701 103 and 0701 106 or all digital gauges

		Ref. No.	List price Euro
⏏	🏠	0710 101	46.40

### 0710 Lug back

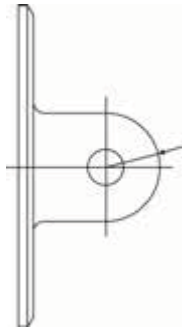

#### Specification

- Ø 5 mm
- For retrofitting
- Cannot be used in conjunction with dial gauges 0701 103 and 0701 106 or any digital gauges

		Ref. No.	List price Euro
⏏	🏠	<b>For dial gauges with an outer ring (Bezel) dia. 40 mm</b>	
		0710 102	6.10
		<b>For dial gauges with an outer ring (Bezel) dia. 58 mm</b>	
		0710 103	6.30

Jean Louis MENEGON - Votre représentant et Conseiller- Tél. : 06 76 08 96 83  
 E-mail: [jlouismenegon@aol.com](mailto:jlouismenegon@aol.com) - web: [www.menegon-metrologie.com](http://www.menegon-metrologie.com)

### 0710 Spindle lifting lever

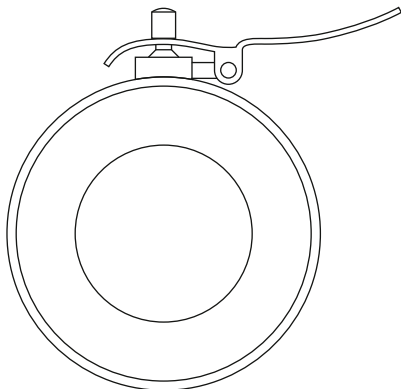

#### Specification

- For dial gauges with a measuring range max. 10 mm
- Cannot be used in conjunction with dial gauges 0701 103 and 0701 106 or any digital gauges

		Ref. No.	List price Euro
⏏	🏠	<b>For dial gauges with an outer ring (Bezel) dia. 40 mm</b>	
		0710 104	9.70
		<b>For dial gauges with an outer ring (Bezel) dia. 58 mm</b>	
		0710 105	9.70



# HELIOS • PREISSER

## 0724 Angle lever attachment



### Specification

- With  $\varnothing$  8 mm mounting hole for dial gauges
- Clamping shank  $\varnothing$  8 mm
- Smallest measurable hole: 6 mm
- Measuring span: 10 mm

### Shipment

- Cardboard box

		Measuring depth mm	Ref. No.	List price Euro
		60	0724 101	44.30

## 0710 Extensions for dial gauges

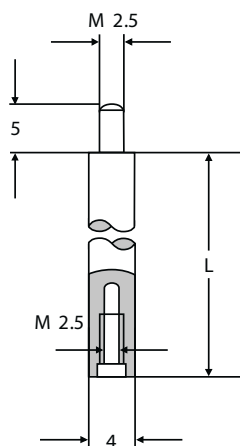

### Specification

- Special steel
- Thread M 2.5

		Length (L) mm	Ref. No.	List price Euro
<b>For measuring spindle dia. 4 mm</b>				
		10	0710 111	4.10
		15	0710 112	4.10
		20	0710 113	4.10
		25	0710 114	4.10
		30	0710 115	4.10
		35	0710 116	4.10
		40	0710 117	4.10
		45	0710 118	4.10
		50	0710 119	4.10
		55	0710 120	4.10
		60	0710 121	4.10
		65	0710 122	4.10
		70	0710 123	4.10
		75	0710 124	4.10
		80	0710 125	4.10
		85	0710 126	4.10
		90	0710 127	4.10
		95	0710 128	4.10
		100	0710 129	4.10

Jean Louis MENEGON - Votre représentant et Conseiller- Tél. : 06 76 08 96 83  
E-mail: [jlouismenegon@aol.com](mailto:jlouismenegon@aol.com) - web: [www.menegon-metrologie.com](http://www.menegon-metrologie.com)



0710 Measuring inserts for dial gauges

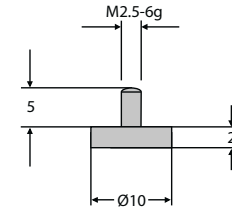
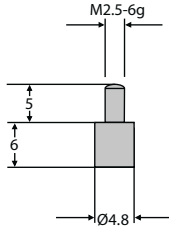

		Material	Ref. No.	List price Euro
		Special steel	0710 161	3.20
		Carbide	0710 261	21.60

		Material	Ref. No.	List price Euro
		Special steel	0710 162	4.10
		Carbide	0710 262	34.90

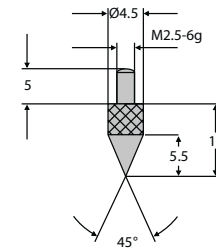
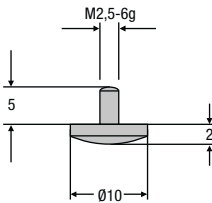

		Material	Ref. No.	List price Euro
		Special steel	0710 163	4.70
		Carbide	0710 263	42.10

		Material	Ref. No.	List price Euro
		Special steel	0710 164	4.70
		Carbide	0710 264	40.70

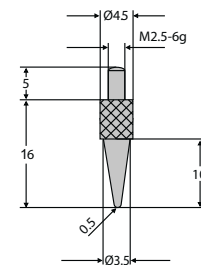
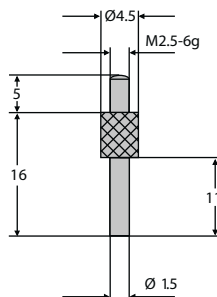

		Material	Ref. No.	List price Euro
		Special steel	0710 165	5.90
		Carbide	0710 265	18.70

		Material	Ref. No.	List price Euro
		Special steel	0710 166	4.30

Jean Louis MENEGON - Votre représentant et Conseiller- Tél. : 06 76 08 96 83

E-mail: [jlouismenegon@aol.com](mailto:jlouismenegon@aol.com) - web: [www.menegon-metrologie.com](http://www.menegon-metrologie.com)



0710 Measuring inserts for dial gauges

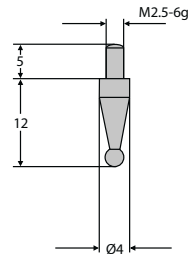
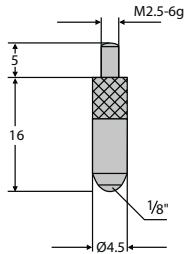

		Material	Ref. No.	List price Euro
		Special steel	0710 167	3,00
		Carbide	0710 267	9,90
		Ruby	0710 367	7,70
		Sapphire	0710 467	7,70

		Ball dia. mm	Ref. No.	List price Euro
<b>Special steel, Tolerance of the ball diameter ±1 µm</b>				
		1.0	0710 169	5.90
		1.5	0710 170	5.90
		2.0	0710 171	5.90
		2.5	0710 172	5.90
		3.0	0710 173	5.90
		3.5	0710 174	5.90
		4.0	0710 175	5.90
		4.5	0710 176	5.90
		5.0	0710 177	5.90
		5.5	0710 178	5.90
		6.0	0710 179	5.90
		6.5	0710 180	5.90

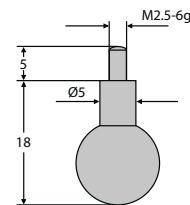
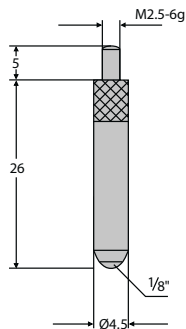

Jean Louis MENEGON - Votre représentant et Conseiller- Tél. : 06 76 08 96 83  
 E-mail: [jlouismenegon@aol.com](mailto:jlouismenegon@aol.com) - web: [www.menegon-metrologie.com](http://www.menegon-metrologie.com)

		Material	Ref. No.	List price Euro
		Special steel	0710 168	3.00
		Carbide	0710 268	9.90
		Ruby	0710 368	7.70
		Sapphire	0710 468	7.70

		Ball dia. mm	Ref. No.	List price Euro
<b>Special steel</b>				
		7.0	0710 181	5.90
		7.5	0710 182	5.90
		8.0	0710 183	5.90
		8.5	0710 184	5.90
		9.0	0710 185	5.90
		9.5	0710 186	5.90
		10.0	0710 187	5.90
		10.5	0710 188	5.90
		11.0	0710 189	5.90

3



0710 Measuring inserts for dial gauges

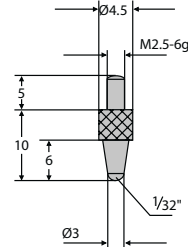
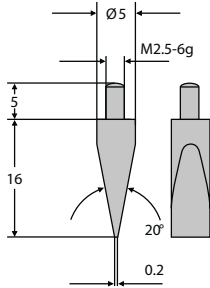

		Material	Ref. No.	List price Euro
		Special steel	0710 192*	6.30
		Carbide	0710 292*	44.30

		Material	Ref. No.	List price Euro
		Special steel	0710 193	4.30

\* with locknut

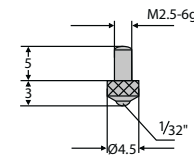
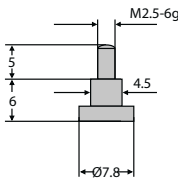

		Material	Ref. No.	List price Euro
		Special steel	0710 194	4.20

		Material	Ref. No.	List price Euro
		Special steel	0710 195	1.00

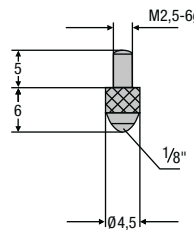
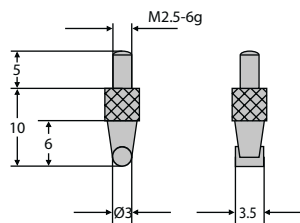

		Material	Ref. No.	List price Euro
		Special steel	0710 196*	6.90

		Material	Ref. No.	List price Euro
		Special steel	0710 197	1.00
		Carbide	0710 297	4.10
		Ruby	0710 397	5.50
		Sapphire	0710 497	5.50

\* with locknut

Jean Louis MENEGON - Votre représentant et Conseiller- Tél. : 06 76 08 96 83  
E-mail: [jlouismenegon@aol.com](mailto:jlouismenegon@aol.com) - web: [www.menegon-metrologie.com](http://www.menegon-metrologie.com)



# HELIOS • PREISSER

## 0715 Dial test indicators



### Specification

- Carbide tipped measuring inserts, Ø 20 mm
- Form A in accordance to DIN 2270
- Revolving dial
- 3-piece swallow tail guide
- Automatic reversal of the counting direction
- Measuring force 0.15 N

### Shipment

- Includes clamping shank Ø 8 mm and key for measuring inserts
- Case

**DIN 2270**

		Measuring range mm	Reading mm	Outer ring (Bezel) dia. mm	Contact insert length mm	Dial	Ref. No.	List price Euro
		±0.4	0.01	30.0	14.5	0-40-0	0715 101	74.00
		±0.4	0.01	40.5	14.5	0-40-0	0715 103	83.00
		±0.1	0.002	30.0	14.5	0-100-0	0715 305	99.00
		±0.1	0.002	40.5	14.5	0-100-0	0715 303	104.00
		±0.25	0.01	30.0	41.2	0-25-0	0715 201	116.00
		±0.5	0.01	40.5	32.3	0-50-0	0715 307	148.00

3

## 0715 Clamping shanks for dial test indicators

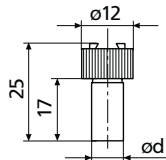

		Diameter mm	Ref. No.	List price Euro
		4h6	0715 903	11.20
		8h6	0715 907	11.20

## 0715 Measuring inserts with carbide ball

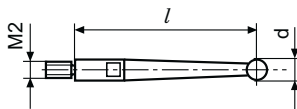

		Ball dia. mm	Length mm	Ref. No.	List price Euro
		1.0	14.5	0715 915	15.60
		2.0	14.5	0715 917	12.30
		3.0	14.5	0715 919	12.30
		1.0	32.3	0715 921	17.20
		2.0	32.3	0715 922	13.00
		3.0	32.3	0715 923	12.90
		1.0	41.2	0715 925	15.80
		2.0	41.2	0715 926	12.30
		3.0	41.2	0715 929	12.30

Jean Louis MENEGON - Votre représentant et Conseiller - Tél. : 06 76 08 96 83  
E-mail: [jlouismenegon@aol.com](mailto:jlouismenegon@aol.com) - web: [www.menegon-metrologie.com](http://www.menegon-metrologie.com)

## 0715 Key for measuring inserts



		Ref. No.	List price Euro
		0715 940	23.40





### 0715 Universal clamp

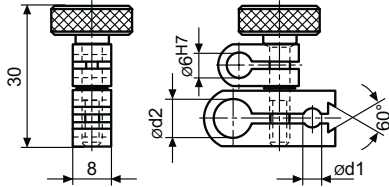

⊗	⊗	Diameter mm	Ref. No.	List price Euro
		8	0715 950	23.40

- Suitable in conjunction with holder 0715 955

### 0715 Holder

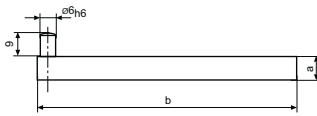

⊗	⊗	Length mm	Cross section mm	Ref. No.	List price Euro
		100	9 x 9	0715 955	14.80

### 0716 Dial depth gauges with a measuring base



0716 101



0716 111

#### Specification

- Measuring base is made of stainless steel, hardened
- Replacement probe tip M 2,5
- Revolving dial
- Factory standard

#### Shipment

- Cardboard box

Jean Louis MENEGON - Votre représentant et Conseiller- Tél. : 06 76 08 96 83

E-mail: [jlouismenegon@aol.com](mailto:jlouismenegon@aol.com) - web: [www.menegon-metrologie.com](http://www.menegon-metrologie.com)

⊗	⊗	Measuring range mm	Reading mm	Contact surface measuring base mm	Range per revolution mm	Dial gauge dia. mm	Ref. No.	List price Euro
		0 - 10	0.01	100 x 15	1	58	0716 101	129.00
<b>Concentric pointer</b>								
		0 - 30	0.01	150 x 15	1	58	0716 102	189.00
		0 - 30	0.01	100 x 15	1	58	0716 105	169.00
<b>Prismatic base</b>								
		0 - 30	0.01	for dia. 10 - 100	1	58	0716 111	249.00

### 0716 Depth measuring base for indicators



#### Specification

- Special steel, chrome plated
- Mounting for indicator  
Ø 8 mm

#### Shipment

- Cardboard box

⊗	⊗	Contact surface mm	Ref. No.	List price Euro
		80 x 15	0716 192	55.00
		100 x 15	0716 194	67.00
		150 x 15	0716 196	87.00



0718 Dial thickness gauges



0718 101



0718 112



Specification

- Frame is made of an aluminium alloy
- Factory standard
- When ordering please specify the gauge form

Shipment

- Cardboard box

Jean Louis MENEGON - Votre représentant et Conseiller- Tél. : 06 76 08 96 83

E-mail: [jlouismenegon@aol.com](mailto:jlouismenegon@aol.com) - web: [www.menegon-metrologie.com](http://www.menegon-metrologie.com)

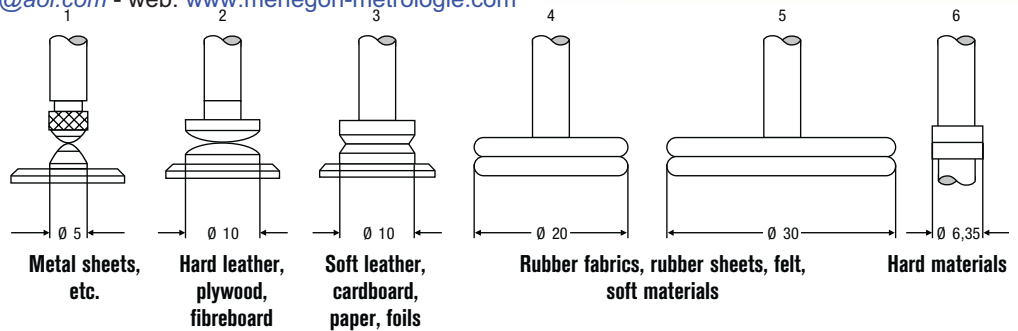

⊗	⚙	Measuring range mm	Reading mm	Type of contact points selectable	Frame depth mm	Ref. No.	List price Euro
		10	0.1	1 / 2 / 3 / 6	15	0718 101	47.10
		20	0.1	1 - 5	50	0718 104	98.00
		30	0.1	1 - 5	50	0718 105	111.00
		50	0.1	1 - 5	50	0718 106	168.00
<b>With a lifting device and stand, range per revolution 10 mm</b>							
		30	0.1	1 - 5	200	0718 108	144.00
		30	0.1	1 - 5	300	0718 109	166.00
		30	0.1	1 - 5	400	0718 110	185.00
<b>With a lifting wheel and concentric pointers, range per revolution 1 mm</b>							
		10	0.01	1 / 2 / 3 / 6	18	0718 112	93.00
		10	0.01	1 / 2 / 3 / 6	45	0718 113	107.00
<b>With a lifting device, range per revolution 1 mm</b>							
		10	0.01	1 - 5	50	0718 115	111.00



## 0720 Dial thickness gauges



0720 102

### Specification

- With a lifting device
- Factory standard
- Frame is made of an aluminium alloy
- Revolution counter
- **Ref. No. 0720 102**  
Tube wall thickness dial gauge with 2 exchangeable probes
  - with bund radius = 1 mm, dia. 8 mm
  - cylindrical dia. 6 mm
- **Ref. No. 0720 103**  
Foil thickness gauge, measuring insert dia. 6.35 mm, flat, thermally insulated

### Shipment

- Cardboard box



0720 103

		Measuring range mm	Reading mm	Range per revolution mm	Frame depth mm	Ref. No.	List price Euro
<b>Tube wall thickness dial gauge</b>							
		10	0.01	1	50	0720 102	147.00
<b>Foil thickness dial gauge</b>							
		1	0.001	0.2	30	0720 103	210.00

Jean Louis MENEGON - Votre représentant et Conseiller- Tél. : 06 76 08 96 83

E-mail: [jlouismenegon@aol.com](mailto:jlouismenegon@aol.com) - web: [www.menegon-metrologie.com](http://www.menegon-metrologie.com)



0721 Internal caliper gauges



0721 120

Specification

- Protection class IP65

Shipment

- Cardboard box



⊗	☒	Measuring range mm	Reading mm	Measuring depth mm	For grooves		Ref. No.	List price Euro
					max. depth	min. width		
<b>Contact point type "A", cutting (chisel) radius 0.1 mm</b>								
		2.5 - 12.5	0.005	12	0.7	0.6	0721 100	473.00
<b>Contact point type "B", carbide ball Ø 0.6 mm</b>								
		5 - 15	0.005	35	2.2	0.8	0721 101	473.00
<b>Contact point type "B", carbide ball Ø 1.0 mm</b>								
		10 - 30	0.01	85	5.2	1.2	0721 120	490.00
<b>Contact point type "C", carbide ball Ø 1.0 mm</b>								
		20 - 40	0.01	85	7.0	1.2	0721 121	490.00
		30 - 50	0.01	85	7.0	1.2	0721 122	490.00
<b>Contact point type "D", carbide ball Ø 1.0 mm</b>								
		40 - 60	0.01	85	8.3	1.2	0721 123	490.00
		50 - 70	0.01	85	8.3	1.2	0721 124	506.00
		60 - 80	0.01	85	8.3	1.2	0721 125	506.00
		70 - 90	0.01	85	8.3	1.2	0721 126	506.00
		80 - 100	0.01	85	8.3	1.2	0721 127	506.00

Jean Louis MENEGON - Votre représentant et Conseiller- Tél. : 06 76 08 96 83

E-mail: [jlouismenegon@aol.com](mailto:jlouismenegon@aol.com) - web: [www.menegon-metrologie.com](http://www.menegon-metrologie.com)



0721 External caliper gauges



Specification

- Protection class IP65

Shipment

- Cardboard box



0721 144

Jean Louis MENEGON - Votre représentant et Conseiller- Tél. : 06 76 08 96 83  
E-mail: [jlouismenegon@aol.com](mailto:jlouismenegon@aol.com) - web: [www.menegon-metrologie.com](http://www.menegon-metrologie.com)



0721 149

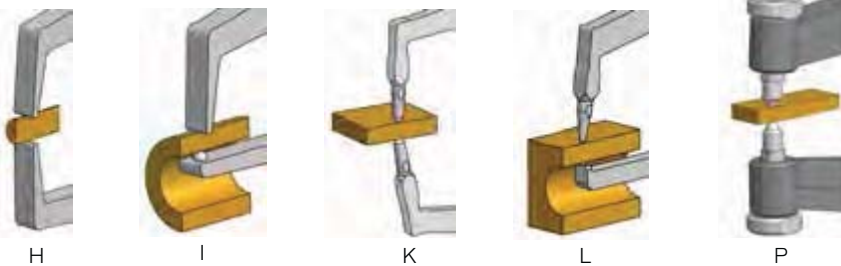

H

I

K

L

P

⊗	☒	Measuring range mm	Reading mm	Measuring depth	Contact point length		Ref. No.	List price Euro
					moving	fixed		
<b>Contact point type "H", cutting chisel radius 0.4 mm</b>								
		0 - 10	0.005	35	18.8	18.5	0721 141	473.00
<b>Contact point type "I", fixed arm, carbide ball Ø 1.5 mm, moving arm, cutting (chisel) radius R = 0.4 mm</b>								
		0 - 10	0.005	35	18.8	0.9	0721 142	473.00
<b>Contact point type "K", carbide ball Ø 1.5 mm</b>								
		0 - 10	0.005	35	19.1	18.6	0721 143	473.00
		0 - 20	0.01	85	24.6	24.6	0721 144	473.00
<b>Contact point type "L", carbide ball Ø 1.5 mm, 1 straight probe arm</b>								
		0 - 20	0.01	80	24.7	2.5	0721 145	473.00
<b>Contact point type "P", carbide ball Ø 5.0 mm</b>								
		0 - 10	0.1	36	5.0	5.0	0721 140	134.00
<b>Contact point type "K", carbide ball Ø 3.0 mm</b>								
		0 - 50	0.05	167	30.0	30.0	0721 148	720.00
<b>Contact point type "L", carbide ball Ø 3.0 mm, 1 straight probe arm</b>								
		0 - 50	0.05	169	30.0	4.6	0721 149	720.00



0721 Digital internal caliper gauges



0721 732



0721 738

Specification



- Protection class IP67

Electronic functions

- ON/OFF switch
- mm/inch conversion
- Absolute/relative measurement
- Tolerance function
- Red/green indication
- (LED) for tolerance measurements
- Data output

Shipment

- Cardboard box

3

Jean Louis MENEGON - Votre représentant et Conseiller- Tél. : 06 76 08 96 83  
E-mail: [jlouismenegon@aol.com](mailto:jlouismenegon@aol.com) - web: [www.menegon-metrologie.com](http://www.menegon-metrologie.com)



B

C

D

⊗	☒	Measuring range mm	Reading mm	Measuring depth	For grooves		Ref. No.	List price Euro
					max. depth	min. width		
<b>Contact point type "B", carbide ball dia 0.6 mm</b>								
		5 - 15	0.005	35	2.3	0.8	0721 731	506.00
<b>Contact point type "C", carbide ball Ø 1.0 mm</b>								
		10 - 30	0.01	85	5.2	1.2	0721 732	506.00
		20 - 40	0.01	85	7.0	1.2	0721 733	506.00
		30 - 50	0.01	85	7.0	1.2	0721 734	506.00
<b>Contact point type "C", carbide ball Ø 1.3 mm</b>								
		13 - 43	0.02	127	5.7	1.6	0721 738	645.00
<b>Contact point type "D", carbide ball Ø 2.0 mm</b>								
		50 - 80	0.02	132	8.3	2.4	0721 739	645.00
<b>Contact point type "C", carbide ball Ø 1.5 mm</b>								
		15 - 65	0.02	188	5.5	1.9	0721 740	890.00



## 0721 Digital external caliper gauges



0721 745

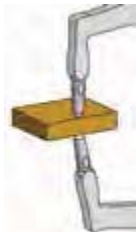

K



L

### Electronic functions

- ON/OFF switch
- mm/inch conversion
- Absolute/Relative measurement
- Tolerance function
- Red/green-indication (LED) for tolerance measurements
- Data output

### Specification

- Protection class IP67

### Shipment

- Cardboard box

Icon	Icon	Measuring range mm	Reading mm	Measuring depth mm	Contact point length		Ref. No.	List price Euro
					moving	fixed		
<b>Contact point type "K", carbide ball Ø 1.5 mm</b>								
		0 - 20	0.01	85	24.7	24.6	0721 741	506.00
<b>Contact point type "K", carbide ball Ø 3.0 mm</b>								
		0 - 30	0.02	116	30.0	30.0	0721 745	645.00
<b>Contact point type "L", carbide ball Ø 3.0 mm, straight lower probe arm</b>								
		0 - 30	0.02	116	30.0	4.0	0721 746	645.00
<b>Contact point type "K", carbide ball Ø 3.0 mm</b>								
		0 - 50	0.02	167	30.0	30.0	0721 747	890.00

## 0721 Accessories for caliper gauges



	Ref. No.	List price Euro
Data interface (adapter and cable) for USB*	0721 786	135.00
Data interface (adapter and cable) for Digimatic*	0721 785	135.00

\* When placing an order, please specify the reference no. and the type of the caliper gauge.

Jean Louis MENEGON - Votre représentant et Conseiller- Tél. : 06 76 08 96 83

E-mail: [jlouismenegon@aol.com](mailto:jlouismenegon@aol.com) - web: [www.menegon-metrologie.com](http://www.menegon-metrologie.com)



## 0727 Set of DIGI-MET® 2 point internal micrometers



### Specification

- Switchable increment value 0.01/0.001/0.0005 mm
- Protection class IP65
- LCD-display 6 mm
- Hard chrome plated measuring head
- For fast and accurate measurements of small holes
- Compact design in ballpoint pen and can be used everywhere for mobile use
- Setting with setting ring

### Electronic functions

- ON/OFF switch
- mm/inch conversion
- Hold function
- Data output RS 232 Proximity
- PRESET Function (setting a numerical value)

### Shipment

- Wooden case

3

⏏	📏	Measuring range mm	Measuring depth mm	Repeatability µm	No. of probes	Setting ring dia. mm	Ref. No.	List price Euro
		0.95 - 1.55	0.60 - 11	1	5	1 / 1.1 / 1.2 / 1.3 / 1.4	0727 752	2,450.00
		1.50 - 2.45	0.90 - 17	1	3	1.75 / 2 / 2.25	0727 755	1,540.00
		2.25 - 4.25	1.20 - 22	1	7	2.5 / 2.75 / 3 / 3.25 / 3.5 / 3.75 / 4	0727 758	2,190.00
		3.65 - 6.35	2.00 - 40	1	5	4 / 4.5 / 5 / 5.5 / 6	0727 761	1,740.00

## Depth stops for 0727



⏏	📏	Measuring range mm	Ref. No.	List price Euro
		0.95 - 1.55	0727 772	21.50
		1.50 - 2.45	0727 775	21.50
		2.25 - 4.25	0727 778	21.50
		3.65 - 6.35	0727 781	21.50

### Accessories

	Ref. No.	List price Euro
Battery, 1.5V type 357	0220 204	3.50
USB-keyboard interface cable RS 232 Proximity	0997 772	232.00





## 0726 Internal precision bore gauges, set for smaller bores



## Specification

- 2 point comparator measuring instrument with split probe + measuring pin
- Excludes a dial gauge
- Without a setting ring
- Mounting hole Ø 8 mm
- Ideal in conjunction with dial gauges or dial comparator gauges

## Shipment

- Wooden case

		Nominal meas. range mm	Effective meas. range mm	Measuring depth mm	Number of probes	Ref. No.	List price Euro
<b>Hardened chrome finished probe</b>							
		4.5 - 7.5	4.15 - 7.8	41-45	7	0726 310	640.00
		8.0 - 12.0	7.7 - 12.5	45	6	0726 311	655.00
		4.5 - 12.0	4.15 - 12.5	41-45	13	0726 312	1,040.00
		13.0 - 20.0	12.2 - 20.6	45	8	0726 313	750.00
<b>Carbide tipped probe</b>							
		1.0 - 1.4	0.95 - 1.55	13	5	0726 500	645.00
		1.75 - 4.0	1.5 - 4.2	17-25	10	0726 501	920.00
		1.0 - 4.0	0.95 - 4.2	13-25	15	0726 502	1,430.00
		4.5 - 7.5	4.15 - 7.8	41-45	7	0726 510	980.00
		8.0 - 12.0	7.7 - 12.5	45	6	0726 511	935.00
		4.5 - 12.0	4.15 - 12.5	41-45	13	0726 512	1,750.00
		13.0 - 20.0	12.2 - 20.6	45	8	0726 513	1,080.00

## Accessories for 0726

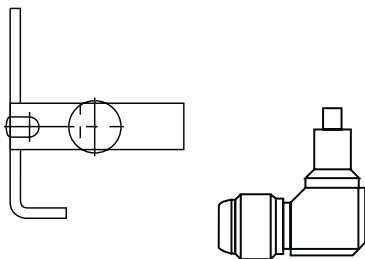

		For measuring range mm	Ref. No.	List price Euro
<b>Clamp with depth stop</b>				
		1.0 - 4.0	0726 122	138.00
		4.5 - 9.0	0726 123	126.00
		10.0 - 20.0	0726 124	119.00
<b>Angle probe 90°</b>				
		1.0 - 20.0	0726 130	218.00

Jean Louis MENEGON - Votre représentant et Conseiller- Tél. : 06 76 08 96 83

E-mail: [jlouismenegon@aol.com](mailto:jlouismenegon@aol.com) - web: [www.menegon-metrologie.com](http://www.menegon-metrologie.com)

## Set of setting rings



		For measuring range mm	Set pieces	Ref. No.	List price Euro
		1.0 - 1.4	5	0726 300	281.00
		8.0 - 12.0	6	0726 301	282.00
		1.0 - 4.0	15	0726 302	895.00
		4.5 - 12.0	13	0726 303	635.00
		13.0 - 20.0	8	0726 304	395.00
		1.75 - 4.0	10	0726 305	485.00
		4.5 - 7.5	7	0726 306	315.00



# HELIOS • PREISSER

Jean Louis MENEGON - Votre représentant et Conseiller- Tél. : 06 76 08 96 83

E-mail: [jlouismenegon@aol.com](mailto:jlouismenegon@aol.com) - web: [www.menegon-metrologie.com](http://www.menegon-metrologie.com)

## 0728 Internal precision bore gauges for large and deep bores



### Specification

- 2 point comparator measuring instrument to determine the reversal point
- Centering plate
- Mounting hole Ø 8 mm
- Ideal in conjunction with dial gauges or dial comparator gauges
- Excludes dial gauge

### Shipment

- Wooden case



⊗	☒	Measuring range mm	Measuring depth mm	Repeatability $\mu\text{m}$	Number of measuring pins	Measuring discs	Ref. No.	List price Euro
<b>Fixed measuring pins, hardened special steel, interchangeable contact pins carbide tipped</b>								
		18 - 35	110	0.5	9	2	0728 105	365.00
		35 - 60	138	0.5	7	2	0728 106	355.00
		50 - 100	177	0.5	11	3	0728 107	405.00
		100 - 160	234	0.5	7	4	0728 108	565.00
		160 - 290	234	0.5	7	4	0728 109	815.00
		280 - 510	400	1.5	7	4	0728 110	1,925.00
<b>Fixed measuring pins and interchangeable contact pins, both pins are carbide tipped</b>								
		4.5 - 6	80	0.5	9	—	0728 201	930.00
		6 - 8	100	0.5	7	—	0728 202	665.00
		8 - 12	100	0.5	9	—	0728 203	620.00
		12 - 20	110	0.5	9	1	0728 204	430.00
		18 - 35	110	0.5	9	2	0728 205	435.00
		35 - 60	138	0.5	7	2	0728 206	415.00
		50 - 100	177	0.5	11	3	0728 207	485.00
		100 - 160	234	0.5	7	4	0728 208	630.00
		160 - 290	234	0.5	7	4	0728 209	835.00
		280 - 510	400	1.5	7	4	0728 210	1,970.00

3

## 0728 Setting device for internal precision bore gauges



### Specification

- Setting device for accurate adjustment of internal precision bore gauges to the required nominal dimension, with gauge blocks
- The setting jaws are made of carbide and are lapped to gauge block quality
- Setting device can be used

in both, the vertical and horizontal measuring axis

- Supplied with: Stand (excludes gauge blocks)

### Shipment

- Wooden case

⊗	☒	For measuring range mm	Accuracy $\mu\text{m}$	Ref. No.	List price Euro
		4.5 - 160	2.0	0728 910	1,150.00
		18 - 290	2.0	0728 915	1,140.00
		160 - 510	2.0	0728 920	1,650.00



## 0735 Crankshaft gauges



### Specification

- With dial gauge
- To be positioned between 2 crank arms
- Centre punch is not required
- Horizontal position of the dial gauge is assured with a plumb bob

### Shipment

- Wooden case



		Measuring range mm	Reading mm	Ref. No.	List price Euro
		45 - 150	0.01	0735 101	377.00
		60 - 300	0.01	0735 102	340.00
		60 - 500	0.01	0735 103	395.00

## 0736 Length measuring instruments for external incisions

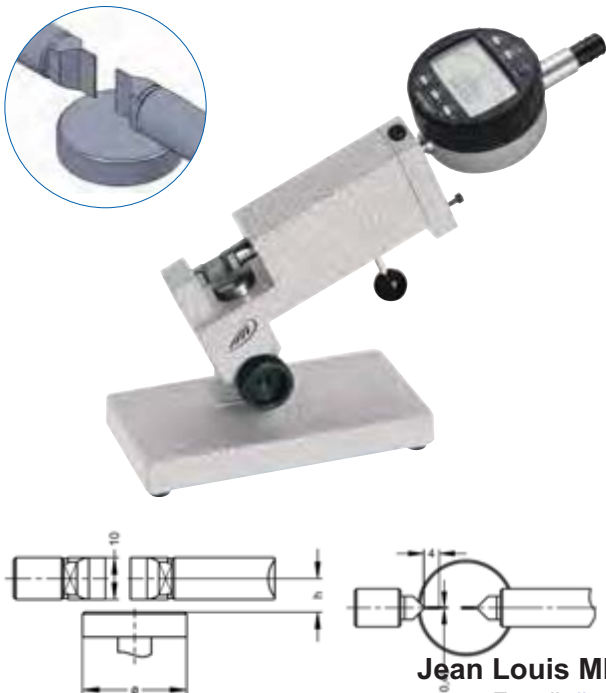

### Specification

- Ideal for serial measurements of incision diameters on turned parts
- Narrow measuring faces made of hardened steel
- High precision ball guide of the transmission bolt
- Round support table, height adjustable, clamped for setting the exact measuring position
- Heavy stand
- Base unit in the angular grid 0°/30°/60°/90°
- Titled and clamped
- Support for indicators with shaft Ø 8 mm
- Display devices: analogue or digital indicators
- Versions with other measuring inserts are available upon request

### Shipment

- Without digital indicator (indicators see pages 118 and following)
- Cardboard box

Jean Louis MENEGON - Votre représentant et Conseiller- Tél. : 06 76 08 96 83

E-mail: [jlouismenegon@aol.com](mailto:jlouismenegon@aol.com) - web: [www.menegon-metrologie.com](http://www.menegon-metrologie.com)

		Measuring range mm	Support table-Ø mm	Max. distance "h" mm	Ref. No.	List price Euro
		0 - 10	25	8	0736 101	870.00
		0 - 25	38	13	0736 102	938.00
		25 - 50	50	35	0736 103	1,005.00



0737 Length measuring instrument for internal incisions

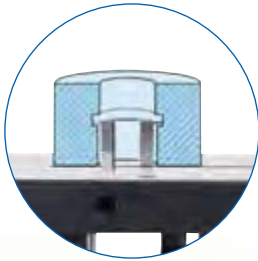

Specification

Shipment

- Ideal for serial measurements of internal incision diameters
  - High precision probe guidance with a constant measuring force
  - Adjust the height with a gauge block
  - Set the diameter with a setting ring
  - Measuring table plate size 110 x 73 mm
  - Mounting hole Ø 8 mm
  - Ideal for analogue and digital dial gauges as well as electronic probes
  - Optional angled probes made of hardened steel
- Without probe
  - Cardboard box

⌘	📄	Internal diameter mm	Ref. No.	List price Euro
		4 - 56	0737 101	847.00

3

Measuring probes (pair) made of hardened steel for 0737

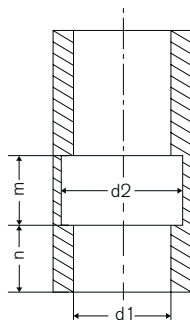

⌘	📄	For bore dia. "d1" mm	Max. incision dia. "d2" mm	Min. groove width "m" Ø mm	Adjustable meas. height "n" mm	Ref. No.	List price Euro
		4 - 28	d1 + 2 mm	0.74	0 - 8	0737 121	84.00
		6.5 - 30	d1 + 4 mm	1.0	0 - 10	0737 122	84.00
		13 - 38	d1 + 2 mm	1.2	0 - 18	0737 123	84.00
		20.5 - 51	d1 + 4 mm	1.2	0 - 25	0737 124	84.00

Jean Louis MENEGON - Votre représentant et Conseiller- Tél. : 06 76 08 96 83

E-mail: [jlouismenegon@aol.com](mailto:jlouismenegon@aol.com) - web: [www.menegon-metrologie.com](http://www.menegon-metrologie.com)



## 0739 Universal comparator gauge



Basic comparator gauge consists of:

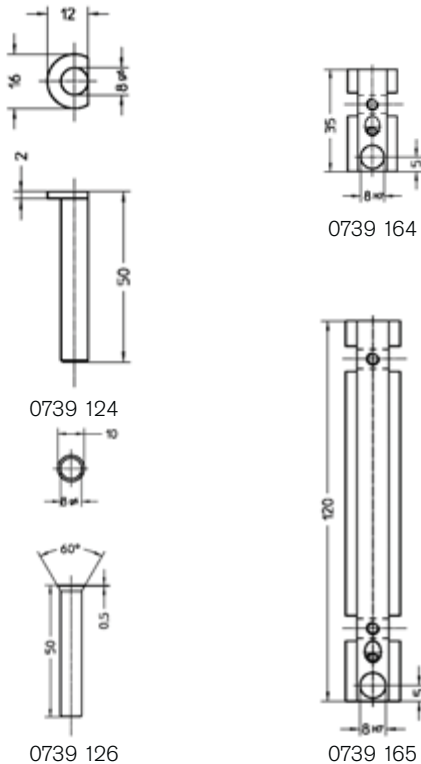

### Specification

- To determine internal and external diameters of recesses, grooves and undercuts in comparison measurement
- Measurement procedure: The part to be measured is determined at the point of reversal between a fixed and moveable measuring insert
- Select either an analogue or digital indicator to show your measuring results
- Sturdy construction
- Simple to set up and easy to operate
- Large range of application
- Ideal for serial measurements
- Optional: Special supporting table is interchangeable
- Internal measurements: 21 – 200 mm
- External measurements: 0 – 180 mm
- Repeatability: 2  $\mu$ m
- Mounting hole for a dial gauge:  $\varnothing$  8 mm
- Supplied with: Pair of measuring inserts 0739 126 and 0739 124, holder for measuring inserts 0739 164 and 0739 165

### Shipment

- Aluminium case

		Dimensions mm	Ref. No.	List price Euro
✕	✕	150 x 150 x 68	0739 102	1,644.00

Jean Louis MENEGON - Votre représentant et Conseiller- Tél. : 06 76 08 96 83

E-mail: [jlouismenegon@aol.com](mailto:jlouismenegon@aol.com) - web: [www.menegon-metrologie.com](http://www.menegon-metrologie.com)



0739 Pairs of measuring inserts

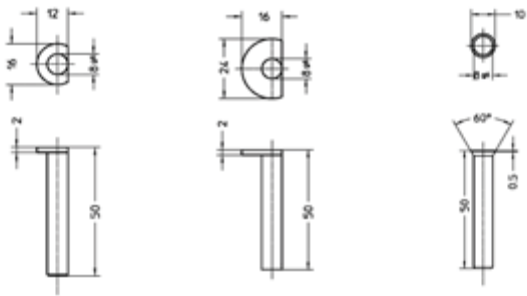

0739 124

0739 125

0739 126

		Item	Ref. No.	List price Euro
		Probe pair	0739 124	99.00
		Probe pair	0739 125	103.00
		Probe pair	0739 126	59.00
		Probe holder	0739 127*	94.00
		Probe holder	0739 128*	59.00
		Probe holder	0739 129*	114.00
		Probe pair	0739 130	95.00
		Small probe pair	0739 131**	103.00
		Holder pair for 0739131	0739 132	137.00

\* For further information regarding probes Ref. No. 0739 127 to 0739 129 see Ref. No. 0710 ... starting on page 131

\*\* Required holder No. 0739 132

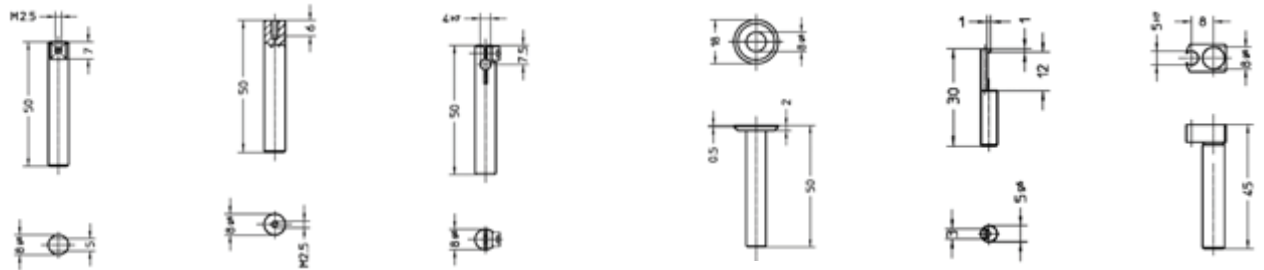

0739 127

0739 128

0739 129

0739 130

0739 131

0739 132

Application examples:

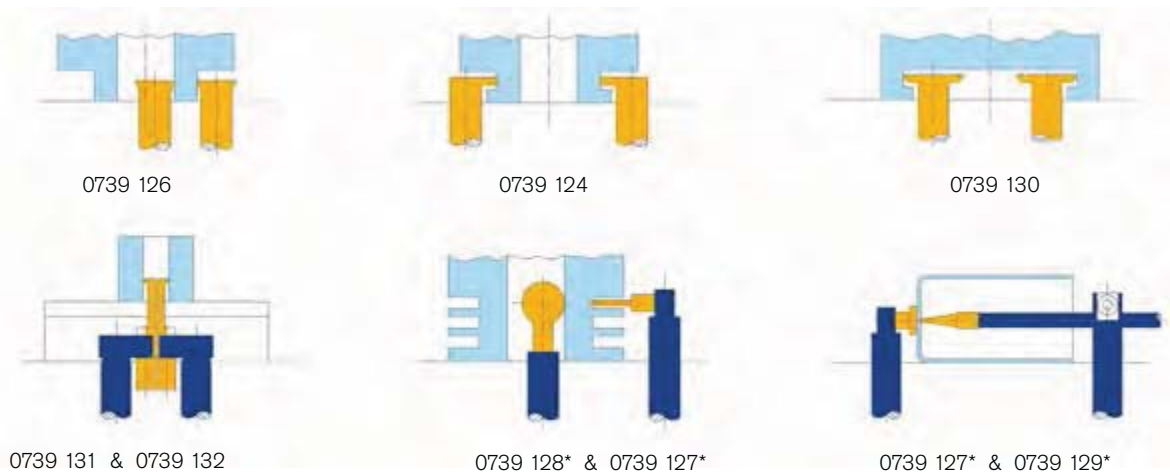

0739 126

0739 124

0739 130

0739 131 & 0739 132

0739 128\* & 0739 127\*

0739 127\* & 0739 129\*

Jean Louis MENEGON - Votre représentant et Conseiller- Tél. : 06 76 08 96 83

E-mail: [jlouismenegon@aol.com](mailto:jlouismenegon@aol.com) - web: [www.menegon-metrologie.com](http://www.menegon-metrologie.com)



### 0739 Holder for measuring inserts short / long

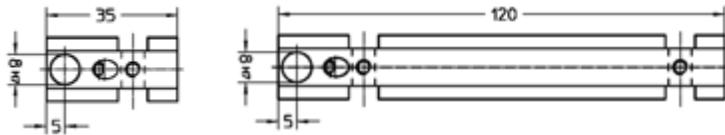

0739 164

0739 165

	Ref. No.	List price Euro
Holder, short	0739 164	35.60
Holder, long	0739 165	44.00

### 0739 Large supporting table

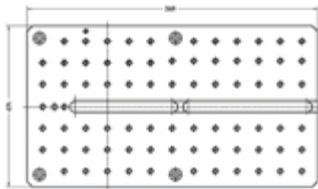

Dimensions mm	Internal measurement mm	External measurement mm	Ref. No.	List price Euro
269 x 149	21 - 320	0 - 300	0739 170	176.00

### 0739 Stop pieces

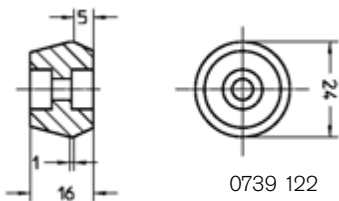

0739 122

Item	Ref. No.	List price Euro
Stop cuboid	0739 121	84.00
Stop disc	0739 122	95.00
Stop stepped cuboid	0739 123	87.00

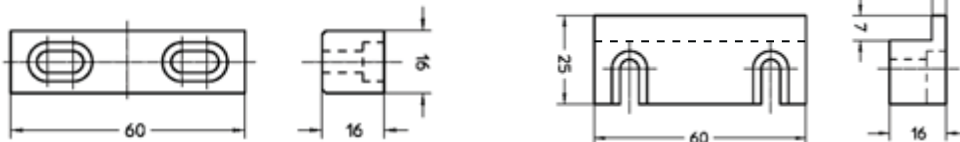

0739 121

0739 123

Application examples:

**Jean Louis MENEGON** - Votre représentant et Conseiller- Tél. : 06 76 08 96 83

E-mail: [jlouismenegon@aol.com](mailto:jlouismenegon@aol.com) - web: [www.menegon-metrologie.com](http://www.menegon-metrologie.com)

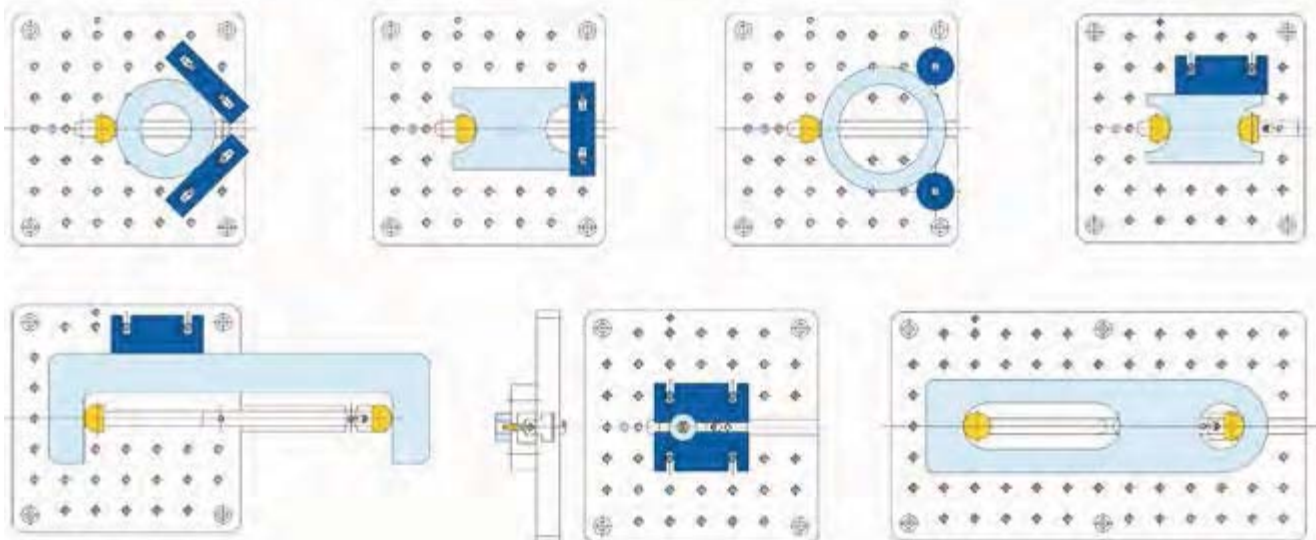



0741 Universal comparator gauge UHRTAST

Jean Louis MENEGON - Votre représentant et Conseiller- Tél. : 06 76 08 96 83  
 E-mail: [jlouismenegon@aol.com](mailto:jlouismenegon@aol.com) - web: [www.menegon-metrologie.com](http://www.menegon-metrologie.com)



3

Specification

- Comparator gauge for external and internal measurements for checking workpieces and setting of machines
- Versatile in use due to wide range of probes and inserts
- Measuring range up to 2000 mm by using optional extensions
- Without indicator
- The direction of the measuring force can be switched, the gauge can be used for external and internal measurements
- The adjustment can be conducted with a setting gauge, a combination of

Shipment

- Wooden case
- gauge blocks, a setting ring or a micrometer
- The measuring range of the moveable measuring arm is 18 mm

Product video







## 0741 Basic comparator gauge



### Specification

- Comparator gauge **for external and internal measurements** for checking workpieces and setting of machines
- Versatile in use due to wide range of probes and inserts
- Measuring range up to 2000 mm by using optional extensions
- Without indicator
- The direction of the measuring force can be switched, the gauge can be used for external and internal measurements
- The adjustment can be conducted with a setting gauge, a combination of

- gauge blocks, a setting ring or a micrometer
- The measuring range of the moveable measuring arm is 18 mm

### Shipment

- Wooden case

		Internal measurement mm	External measurement mm	Ref. No.	List price Euro
		15 - 230	5 - 220	0741 101	1,720.00

## Extensions



0741 112



0741 114



0741 116

		Length mm	Ref. No.	List price Euro
		100	0741 112	240.00
		200	0741 114	254.00
		500	0741 116	388.00

Jean Louis MENEGON - Votre représentant et Conseiller- Tél. : 06 76 08 96 83

E-mail: [jlouismenegon@aol.com](mailto:jlouismenegon@aol.com) - web: [www.menegon-metrologie.com](http://www.menegon-metrologie.com)





# HELIOS • PREISSER

## Pair of probe mounting block

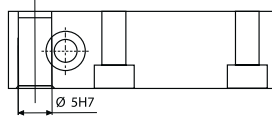

Ref. No.

List price

0741 170

Euro

158.00

## Pairs of ball measuring inserts



0741 178



0741 179



Length  
mm

Ref. No.

List price

23

0741 178

106.00

53

0741 179

106.00

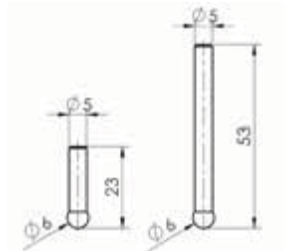
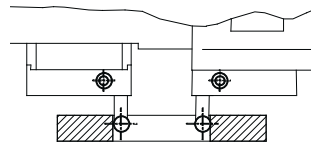

## Pair of cylindrical measuring inserts

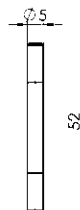
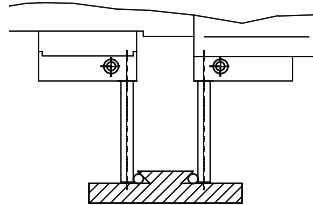

Length  
mm

Ref. No.

List price

52

0741 180

106.00

Jean Louis MENEGON - Votre représentant et Conseiller- Tél. : 06 76 08 96 83

E-mail: [jlouismenegon@aol.com](mailto:jlouismenegon@aol.com) - web: [www.menegon-metrologie.com](http://www.menegon-metrologie.com)

## Pair of offset measuring inserts

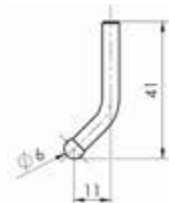
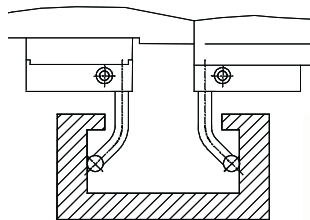

Ref. No.

List price

0741 182

Euro

176.00



### Pair of measuring inserts with discs

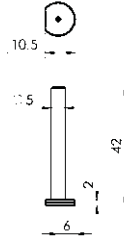
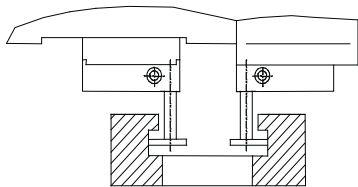

		<b>Ref. No.</b>	<b>List price Euro</b>
		0741 176	106.00

### Pair of shoulder measuring inserts

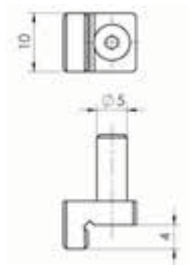
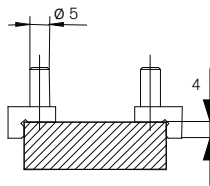

#### Specification

- For measuring external centre points

		<b>Ref. No.</b>	<b>List price Euro</b>
		0741 172	189.00

### Pair of shoulder measuring inserts

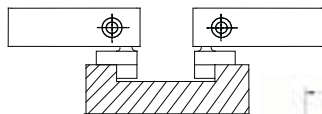

#### Specification

- For measuring internal centre points

		<b>Ref. No.</b>	<b>List price Euro</b>
		0741 174	154.00



Pairs of measuring arms

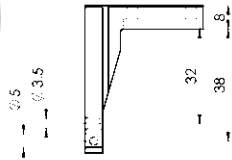

0741 122

		Length mm	Ref. No.	List price Euro
		40	0741 122	249.00
		80	0741 124	299.00

Specification

- Measuring arms are reversible for internal and external measurement
- Mounting bores: 3.5 and 5 mm

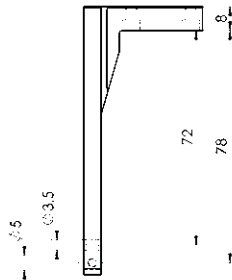

0741 124

3

Pair of depth stop attachment for measuring arms

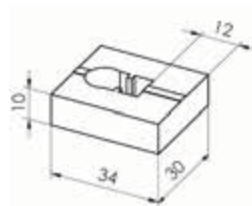
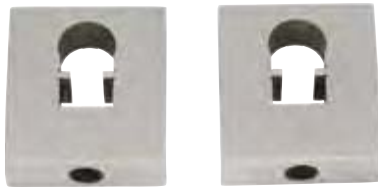

		Ref. No.	List price Euro
		0741 136	232.00

Pair of adapters 5 mm for measuring inserts M2.5

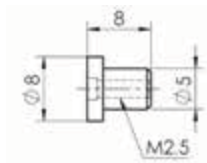

Specification

- All measuring inserts for dial gauges with M2.5 can be used (measuring inserts please refer to pages 132 - 134)

		Ref. No.	List price Euro
		0741 132	81.00

Jean Louis MENEGON - Votre représentant et Conseiller- Tél. : 06 76 08 96 83

E-mail: [jlouismenegon@aol.com](mailto:jlouismenegon@aol.com) - web: [www.menegon-metrologie.com](http://www.menegon-metrologie.com)



### Pair of adapters for thread measuring inserts (pair)

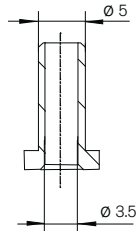

#### Specification

- Adapter for thread measuring inserts with a long shank
- Measuring inserts that have a short shank, the adapter is not required

		Ref. No.	List price Euro
✕	📄	0741 134	141.00

### Pairs of thread measuring inserts for metric internal thread

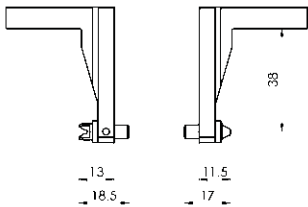

#### Specification

- Thread measuring inserts for internal thread, metric pitch in pairs

✕	📄	Pitch mm	Ref. No.	List price Euro
		1.0 - 1.25	0741 163	202.00
		1.5 - 1.75	0741 164	202.00
		2.0 - 2.5	0741 165	202.00
		3.0 - 3.5	0741 166	202.00
		4.0 - 5.0	0741 167	202.00
		5.5 - 6.0	0741 168	202.00

### Pairs of thread measuring inserts for metric external thread

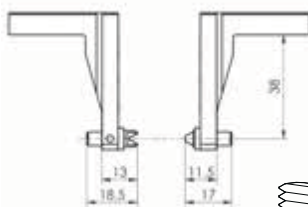

#### Specification

- Thread measuring inserts for external thread, metric pitch in pairs

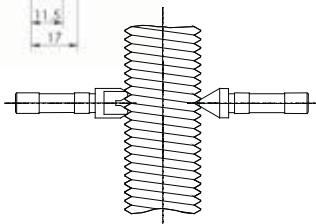

✕	📄	Pitch mm	Ref. No.	List price Euro
		0.35	0741 140	177.00
		0.4 - 0.45	0741 141	100.00
		0.5 - 0.6	0741 142	100.00
		0.7 - 0.8	0741 143	100.00
		1.0 - 1.25	0741 144	100.00
		1.5 - 1.75	0741 145	100.00
		2.0 - 2.5	0741 146	100.00
		3.0 - 3.5	0741 147	100.00
		4.0 - 5.0	0741 148	100.00
		5.5 - 6.0	0741 149	100.00

Additional inserts for whitworth and ISO-trapezoidal threads, see Ref. No. 0870 ... on page 101

### Measuring table



#### Specification

- Consists of a support table dia. = 180 mm, holder for probe, supports

		Ref. No.	List price Euro
✕	📄	0741 184	600.00

Jean Louis MENEGON - Votre représentant et Conseiller- Tél. : 06 76 08 96 83

E-mail: [jlouismenegon@aol.com](mailto:jlouismenegon@aol.com) - web: [www.menegon-metrologie.com](http://www.menegon-metrologie.com)



## 0750 Universal indicator stands with magnetic base

### Specification

- Chrome finished columns
- Base with V-groove
- Magnet with ON/OFF switch
- Mounting clamp: Ø 8 mm for indicators
- Integrated fine adjustment

### Shipment

- Cardboard box



0753 110

0753 120

		Height of column mm	Reach mm	Column / Arm dia. mm	Magnetic base L x B x H mm	Magnetic force N	Ref. No.	List price Euro
		230	140	16/12	60 x 50 x 55	500	0753 110	23.00
		285	180	16/16	60 x 50 x 55	600	0753 120	57.00

Jean Louis MENEGON - Votre représentant et Conseiller- Tél. : 06 76 08 96 83

E-mail: [jlouismenegon@aol.com](mailto:jlouismenegon@aol.com) - web: [www.menegon-metrologie.com](http://www.menegon-metrologie.com)



**0750 Universal indicator stands** with magnetic base and combi clamp



**Specification**

- Chrome plated columns
- Base with V-groove
- Magnet with ON/OFF switch
- **Combi clamp:**  
Ø 8 mm for dial gauges, swallow tail clamp for dial test indicators
- Integrated fine adjustment

**Shipment**

- Without indicator
- Cardboard box



⊗	⊗	Height of column mm	Reach mm	Column / Arm Ø mm	Magnetic base L x B x H mm	Magnetic force N	Ref. No.	List price Euro
<b>Crosshead clamp</b>								
		285	180	16/16	70 x 46 x 65	600	0750 101	129.00
		500	180	20/16	75 x 60 x 80	800	0750 102	172.00

Accessories	Ref. No.	List price Euro
Wooden case for 0750 101 + 0750 102	0750 601	23.20

**Pillar with transverse arm and fine adjustment**



⊗	⊗	For ref.	Ref. No.	List price Euro
		0750 101	0750 121	79.00
		0750 102	0750 122	89.00

**Magnetic base**



⊗	⊗	Thread	Dimensions L x W x H	Magnetic force N	Ref. No.	List price Euro
		M10	70 x 46 x 65	600	0750 111	55.00
		M12	75 x 60 x 80	800	0750 112	101.00

**Jean Louis MENEGON** - Votre représentant et Conseiller- Tél. : 06 76 08 96 83

E-mail: [jlouismenegon@aol.com](mailto:jlouismenegon@aol.com) - web: [www.menegon-metrologie.com](http://www.menegon-metrologie.com)



0752 Magnetic indicator stands with central lock



**Specification**

- Column/Arm:
  - 0752 101 steel, chrome finished
  - 0752 103 aluminium, anodized
- Switch magnetic base with V-groove
- Central magnetic clamping system
- **Combi clamp:** Ø 8 mm for dial gauges, swallow tail clamp for dial test indicators
- Integrated fine adjustment

**Shipment**

- Cardboard box

Jean Louis MENEGON - Votre représentant et Conseiller- Tél. : 06 76 08 96 83  
 E-mail: [jlouismenegon@aol.com](mailto:jlouismenegon@aol.com) - web: [www.menegon-metrologie.com](http://www.menegon-metrologie.com)

		Max height mm	Radius mm	Column / Arm dia. mm	Magnetic base L x W x H mm	Magnetic force N	Ref. No.	List price Euro
		310	260	10	70 x 46 x 65	600	0752 101	133.00
		370	320	18	70 x 46 x 65	600	0752 103	170.00

0754 Universal magnetic holder



**Specification**

- Magnetic base with V-groove
- With mounting hole Ø 8 mm
- Three-sided magnet

**Shipment**

- Cardboard box

		Max. height mm	Support face mm	Magnetic force N	Ref. No.	List price Euro
		57	70 x 35	260	0754 101	91.00





## 0751 Magnetic indicator stands with flexible arm



Jean Louis MENEGON - Votre représentant et Conseiller- Tél. : 06 76 08 96 83

E-mail: [jlouismenegon@aol.com](mailto:jlouismenegon@aol.com) - web: [www.menegon-metrologie.com](http://www.menegon-metrologie.com)



0751 103



0751 104

### Specification 0751 103

- With articulated (flexible) arm
- Eccentric clamp by lever
- Switch magnetic base,

### Specification 0751 104

- Fixed column
- With fine adjustment
- Flexible transverse arm
- Switch magnetic base,

### Shipment

- Cardboard box

		Height of column mm	Base L x W x H mm	Magnetic force N	Ref. No.	List price Euro
<b>Heavy duty stand</b>						
		350	70 x 45 x 65	600	0751 103	109.00
<b>Clamping via. the star knob screw</b>						
		350	70 x 45 x 65	600	0751 104	127.00

## 0756 Universal magnetic holder



### Specification

- Cast iron base with two magnets on the bottom of the holder
- With mounting hole Ø 8 mm

### Shipment

- Cardboard box

		Max. height mm	Support face mm	Magnetic force N	Ref. No.	List price Euro
		45	72 x 37	180	0756 101	55.00



0770 Compact measuring stands



0770 102

Specification

- Cast base
- Chrome finished columns
- Hardened steel table
- With dust grooves (Ref. No. 0770 102 non-stop plane)
- With mounting hole for dial gauges Ø 8 mm

Shipment

- Cardboard box



0770 103



0770 201

Jean Louis MENEGON - Votre représentant et Conseiller- Tél. : 06 76 08 96 83

E-mail: [jlouismenegon@aol.com](mailto:jlouismenegon@aol.com) - web: [www.menegon-metrologie.com](http://www.menegon-metrologie.com)

		Measuring height mm	Reach mm	Column dia. mm	Transverse arm dia. mm	Table surface mm	Ref. No.	List price Euro
<b>With fixed arm</b>								
		100	49	22	—	Ø 50	0770 102	163.00
		100	49	22	—	60 x 68	0770 103	206.00
<b>With adjustable transverse arm</b>								
		100	100	22	18	60 x 68	0770 201	208.00
		150	135	28	20	98 x 115	0770 205	322.00



## 0772 Measuring stand



### Specification

- Cast base
- Hardened steel table
- With dust grooves
- With a threaded column and an adjustable transverse arm
- With mounting hole for dial gauges Ø 8 mm

### Shipment

- Cardboard box

		Measuring height mm	Reach mm	Column dia. mm	Transverse arm dia. mm	Table surface mm	Ref. No.	List price Euro
		160	200	35	22	170 x 215	0772 024	701.00

## 0785 Precision measuring stands



### Specification

- Base made of hard stone
- Base plate accuracy according to DIN 876-00
- With a threaded column and chrome plated transverse arm
- With adjustable transverse arm
- With mounting hole for dial gauges Ø 8 mm
- Vertical adjustment by threaded spindle with setting ring

### Shipment

- Cardboard box

Jean Louis MENEGON - Votre représentant et Conseiller- Tél. : 06 76 08 96 83  
E-mail: [jlouismenegon@aol.com](mailto:jlouismenegon@aol.com) - web: [www.menegon-metrologie.com](http://www.menegon-metrologie.com)

		Meas. height mm	Reach mm	Column dia. mm	Transverse arm dia. mm	Table surface mm	Ref. No.	List price Euro
		200	200	35	22	150 x 260	0785 108	590.00
	▪	220	220	35	22	300 x 350	0785 109	1,446.00
		<b>Anti-twist (secured against rotation) transverse arm</b>						
	▪	220	220	35	22	300 x 350	0785 110	1,662.00



0763 Universal measuring support



Specification

- Column and transverse arm are chrome finished
- Heavy base plate with prismatic base and T-groove
- Column is moving and can be clamped in the T-groove
- Mounting clamp: Ø 8 mm for dial gauges, swallow tail clamp for dial test indicators
- Fine adjustment

Shipment

- Cardboard box

Jean Louis MENEGON - Votre représentant et Conseiller- Tél. : 06 76 08 96 83  
E-mail: [jlouismenegon@aol.com](mailto:jlouismenegon@aol.com) - web: [www.menegon-metrologie.com](http://www.menegon-metrologie.com)

		Height of column mm	Base dimensions L x W x H mm	Transverse arm dia. mm	Ref. No.	List price Euro
		300	250 x 60 x 35	16/16	0763 100	258.00

3

0780 Bench centres



Specification

- Finely ground surface, flatness tolerance according to DIN 876-2
- With two adjustable tailstocks
- Left tailstock with fixed centre
- Right tailstock with retractable spring mounted centre, free lift appr. 10 mm
- Tailstocks can be clamped via an eccentric clamp
- Tailstocks height 75 mm with integrated V-groove support
- Quick-clamping device by clamping lever
- With T-groove and support column
- With mounting hole for dial gauges Ø 8 mm

Shipment

- Cardboard box

		Height of centres mm	Max. work load per tailstock (kg)	Width between centres mm	Centre dia. mm	Width of T grooves mm	Base mm	Ref. No.	List price Euro
		50	5	200	16	10	350 x 110	0780 101	559.00
		50	5	350	16	10	500 x 110	0780 102	709.00
		75	5	200	16	10	350 x 110	0780 104*	639.00
		75	5	350	16	10	500 x 110	0780 105*	728.00
	▪	100	20	450	22	12	700 x 180	0780 107	1,833.00
	▪	150	20	450	22	12	700 x 180	0780 108	2,043.00

\* With integrated V-groove support on the tailstocks



## 0780 Bench centres for heavy workpieces



### Specification

- Finely ground surface, flatness tolerance according to DIN 876-2
- With two adjustable tailstocks
- Left tailstock with fixed centre
- Right heavy tailstock with moveable, spring mounted centre, free lift appr. 10 mm
- Tighten by hand crank
- Tailstocks can be clamped via an eccentric clamp
- Base made of cast iron with T-groove
- Measuring stand with mounting hole for dial gauges Ø 8 mm

### Shipment

- Cardboard box

⌘	📏	Height of centres mm	Max. work load per tailstock (kg)	Width between centres mm	Centre dia. mm	Width of T grooves mm	Base mm	Ref. No.	List price Euro
	▪	100	40	450	22	12	700 x 180	0780 141	1,955.00
	▪	150	40	450	22	12	700 x 180	0780 142	2,212.00

## Pair of v-support inserts



⌘	📏	For height of centres mm	V-support dia. mm	Ref. No.	List price Euro
		50/75	3 - 15	0780 021	81.00
		100	8 - 45	0780 023	123.00

- These v-support inserts replace the pointed inserts in the tailstocks

## Replacement support column



⌘	📏	For height of centres mm	Height of column mm	For width of T grooves mm	Ref. No.	List price Euro
		50/75	200	10	0780 072	97.00
		100	240	12	0780 073	170.00
		150	440	12	0780 074	195.00

Jean Louis MENEGON - Votre représentant et Conseiller- Tél. : 06 76 08 96 83

E-mail: [jlouismenegon@aol.com](mailto:jlouismenegon@aol.com) - web: [www.menegon-metrologie.com](http://www.menegon-metrologie.com)



# HELIOS • PREISSER

Jean Louis MENEGON - Votre représentant et Conseiller- Tél. : 06 76 08 96 83

E-mail: [jlouismenegon@aol.com](mailto:jlouismenegon@aol.com) - web: [www.menegon-metrologie.com](http://www.menegon-metrologie.com)

## Left tailstocks with a rotating collet chuck



		Height of centres mm	For width of T-grooves mm	Collet chuck mm	Ref. No.	List price Euro
		50	10	F10	0780 001	347.00
		75	10	F10	0780 002	385.00
		100	12	F14	0780 003*	600.00

- Collet chucks F10 from 1-7 mm are available upon request
- Collet chucks F14 from 1-10 mm are available upon request\*

## Pair of replacement tailstocks for 0780

### Specification

- As included with the basic bench centre 0780
- 75 mm with V-groove support
- For heavy workpieces, height of centres 100 mm and 150 mm up to a single load of 40 kg on request

		Height of centres mm	For width of T-grooves mm	Ref. No.	List price Euro
		50	10	0780 091	351.00
		75	10	0780 092	395.00
		100	12	0780 093	812.00
		150	12	0780 094	839.00

## Pair of V-groove supports for 0780



### Application

- For workpieces without centering
- Functional test through applying on e.g. plain lateral surface
- Recognition of form errors

### Specification

- Are used instead of the tailstocks on the base
- V-groove surfaces are hardened, replaceable

		Height* mm	For width of T-grooves mm	Surface dia. mm	Ref. No.	List price Euro
		65	10	5 - 25	0780 032	149.00
		100	12	5 - 50	0780 033	214.00

\* based on the center of an axis of a shaft Ø 10 mm

## Pair of roller supports for 0780



### Application

- For workpieces without centering
- Functional test through applying on e.g. plain lateral surface
- Recognition of form errors

### Specification

- Are used in place of the tailstocks on the base
- Runout tolerance of the rollers: 0.005 mm

		Height* mm	Width of T grooves mm	Surface dia. mm	Ref. No.	List price Euro
		65	10	3 - 30	0780 042	178.00
		100	12	4 - 60	0780 043	241.00

\* based on the center of an axis of a shaft Ø 10 mm



## 0783 Bench centre



DIN  
876-1

### Specification

- Dark granite work bench
- Flatness tolerance in accordance to DIN 876-1
- Right tailstock with retractable spring mounted centre (quick adjustment lever)
- Left tailstock with fixed centre
- Tailstocks can be adjusted via an eccentric clamp

### Shipment

- Wooden box
- Supplied with:
  - Work bench
  - Support post
  - 1 pair of tailstocks with pointed alignment centre 60° MK 2

		Height of centres mm	Max. work load per tailstock kg	Width between centres mm	Width of T-grooves mm	Base mm	Ref. No.	List price Euro
	▪	200	24	650	14	1100 x 180 x 140	0783 012	3,274.00

		For centre height mm	Width of T-grooves mm	Ref. No.	List price Euro
<b>Pair of tailstocks</b>					
	▪	200	14	0782 191	1,083.00
<b>Support post</b>					
		200	14	0783 070	273.00
<b>Pointed alignment centre, mount MK 2</b>					
		200	—	0782 181	208.00

## 0783 Pair of roller supports



		Height* mm	For width of T-grooves mm	Surface dia. mm	Ref. No.	List price Euro
		200	14	25 - 100	0782 160	653.00

\* based on the centre of an axis of a shaft Ø 32 mm

**Jean Louis MENEGON** - Votre représentant et Conseiller- Tél. : 06 76 08 96 83

E-mail: [jlouismenegon@aol.com](mailto:jlouismenegon@aol.com) - web: [www.menegon-metrologie.com](http://www.menegon-metrologie.com)



0784 Concentricity measuring gauge with disc supports



3

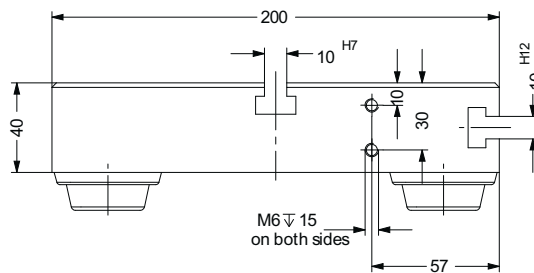

Specification

- Centerless concentricity measuring instrument
- High accuracy discs are being mounted on bearings; free of play
- Discs can be slid to either side on the base
- One sliding disc can be adjusted up to 30 mm for diametral compensation
- Includes the support post,

- excludes a dial gauge
- Concentricity accuracy 5 µm
- Load capacity max. 50 kg (25 kg per tailstock)

Shipment

- Wooden box

		Max. distance between discs mm	Max. workpiece dia. mm	Discs dia. mm	Ref. No.	List price Euro
		400	250	120	0784 108	2,864.00





## 0788 Shaft measuring instrument



Application



application as a bench centre

### Specification

- For rapid measurement of distances, shoulders, taper, roundness, etc.
- Vertical and horizontal alignment
- Vertical base with 3 hardened adjustment support surfaces
- Measuring beam is made of hardened steel
- Load capacity max. 20 kg

### Shipment

- Not supplied with a height gauge
- Cardboard box

		Height of centres mm	Width between centres mm	Width of T-grooves mm	Base mm	Ref. No.	List price Euro
	▪	75	550	10H7	200 x 120	0788 104	1,044.00

### Accessories

	Ref. No.	List price Euro
Measuring stand with guideways	0788 180	212.00



0788 180

Jean Louis MENEGON - Votre représentant et Conseiller- Tél. : 06 76 08 96 83

E-mail: [jlouismenegon@aol.com](mailto:jlouismenegon@aol.com) - web: [www.menegon-metrologie.com](http://www.menegon-metrologie.com)



0788 Shaft measuring instrument lightweight



application as a bench centre

Specification

- For rapid measurement of distances, shoulders, taper, roundness, etc.
- Vertical and horizontal alignment
- Vertical base with 3 hardened adjustment support surfaces
- Measuring beam is made of hard anodised aluminium profile
- Aluminium tailstocks
- Load capacity max. 15 kg

Shipment

- Not supplied with a height gauge
- Cardboard box

Application

Jean Louis MENEGON - Votre représentant et Conseiller- Tél. : 06 76 08 96 83

E-mail: [jlouismenegon@aol.com](mailto:jlouismenegon@aol.com) - web: [www.menegon-metrologie.com](http://www.menegon-metrologie.com)

		Height of centres mm	Width between centres mm	Width of T-grooves mm	Base mm	Ref. No.	List price Euro
	▪	75	550	10.1 + 0.1	200 x 150	0788 904	832.00

Accessories

	Ref. No.	List price Euro
Measuring stand with holder	0788 980	67.00
Measuring stand with guideways	0788 990	301.00



0788 980



0788 990



## NOT SEARCHING, BUT FINDING

We carefully ensure that our wide and extensive range provides a good assortment so that you feel in good hands, even if you are looking for portable measurement devices to provide unusual solutions for tasks. This is why the term "ring gauges" does not refer to the jewellery worn by our trainees, but rather it is an integral part of a seamless range including everything from marking brackets to callipers. If there is something you cannot find and we are able to help, we will make it for you, even as a single piece.

This attention to detail is displayed with exceptional precision: With our laser scaling system, we achieve a precision of  $< 0.0025$  mm on a length of 1000 mm. Whether you need a considerable leap forward in technology or a wide or deep range of products, you will have no trouble finding what you need from us, least of all when it is a matter of maximum accuracy.



## 4. CHAPTER MARKING GAUGES

172	Scribers
173	Dividers
175	Beam compass
177	Internal and external calipers
180	Marking calipers / Marking gauges
184	Height and scribing gauges





## 0300 Scribes



			Length mm	Material	Ref. No.	List price Euro
		<b>With straight screw-in scriber</b>				
			175	Hardened chrome vanadium steel	0300 007	1.90
		<b>With one straight and one L-shaped screw-in scribes</b>				
			250	Hardened chrome vanadium steel	0300 008	2.10
		<b>With one straight and one angled screw-in and burnished scribes</b>				
			200	Hardened chrome vanadium steel	0300 011	1.90
		<b>With straight scriber, ball point pen form, incl. 20 interchangeable marking scribes</b>				
			125	Hardened chrome vanadium steel	0300 013	9.40
		<b>With a mechanic and pocket clip</b>				
			150	Carbide tipped	0300 120	11.80
		<b>One piece hexagonal body with a pocket clip</b>				
			180	Carbide tipped	0300 102	5.20
		<b>With straight screw-in scriber</b>				
			175	Carbide tipped	0300 103	5.20
		<b>With straight scriber, plastic handle</b>				
			110	Carbide tipped	0300 112	4.30
		<b>With one straight and one angled screw-in and burnished scribes</b>				
			250	Carbide tipped	0300 114	8.10

## Replacement scribes



			Length mm	Material	Ref. No.	List price Euro
<b>For scribes 0300 007, 0300 008</b>						
			86	Chrome vanadium steel, straight	0300 009	1.00
<b>For scriber 0300 008</b>						
			80	Chrome vanadium steel, L-shaped	0300 010	1.00
<b>For scriber 0300 013: (Package = 50 pieces)</b>						
			16	Chrome vanadium steel, straight	0300 014	3.20
<b>For scribes 0300 120</b>						
			33	Carbide	0300 130	3.20

Jean Louis MENEGON - Votre représentant et Conseiller- Tél. : 06 76 08 96 83

E-mail: [jlouismenegon@aol.com](mailto:jlouismenegon@aol.com) - web: [www.menegon-metrologie.com](http://www.menegon-metrologie.com)





0301 Precision dividers



Specification

- With a rivetted hinge
- Special steel
- Hardened needle shaped ground points

Shipment

- Cardboard box

✂	☑	Length mm	Ref. No.	List price Euro
		150	0301 001	6.70
		175	0301 002	7.70
		200	0301 003	8.50
		250	0301 004	11.80
		300	0301 005	14.30
		400	0301 006	38.70
		500	0301 007	55.00
		600	0301 008	72.00
		800	0301 009	101.00
		1000	0301 010	148.00

0302 Precision dividers with quadrant



Specification

- With a rivetted hinge
- Special steel
- Quadrant with robust, milled locking screw
- Hardened points

Shipment

- Cardboard box

✂	☑	Length mm	Ref. No.	List price Euro
		150	0302 001	9.90
		175	0302 002	10.90
		200	0302 003	11.60
		250	0302 004	15.20
		300	0302 005	19.90
		400	0302 006	56.00
		500	0302 007	68.00
		600	0302 008	88.00
		800	0302 009	122.00
		1000	0302 010	169.00
<b>With pencil holder</b>				
		150	0306 001	12.60
		200	0306 003	14.30
		300	0306 005	22.30

Jean Louis MENEGON - Votre représentant et Conseiller- Tél. : 06 76 08 96 83  
E-mail: [jlouismenegon@aol.com](mailto:jlouismenegon@aol.com) - web: [www.menegon-metrologie.com](http://www.menegon-metrologie.com)



## 0310 Spring dividers



### Specification

- Quick release set screw
- Special steel
- Fixed points
- Hardened points
- Quick release set screw and spring are burnished

### Shipment

- Cardboard box

		Length mm	Ref. No.	List price Euro
		100	0310 101	3.20
		125	0310 102	3.50
		150	0310 103	3.90
		200	0310 105	4.30
		250	0310 107	5.50
		300	0310 108	6.50

## 0311 Spring dividers



### Specification

- Quick release set screw
- Special steel
- Interchangeable points
- Hardened points
- Quick release set screw and spring are burnished

### Shipment

- Cardboard box

		Length mm	Ref. No.	List price Euro
		100	0311 101	3.20
		125	0311 102	3.70
		150	0311 103	4.30
		200	0311 105	5.20
		250	0311 107	6.30
		300	0311 108	6.70

Jean Louis MENEGON - Votre représentant et Conseiller- Tél. : 06 76 08 96 83  
E-mail: [jlouismenegon@aol.com](mailto:jlouismenegon@aol.com) - web: [www.menegon-metrologie.com](http://www.menegon-metrologie.com)

## Pair of replacement points for spring dividers



		Material	Ref. No.	List price Euro
		Hardened	0311 120	2.10
		Carbide tipped	0311 121	17.60



# HELIOS • PREISSER

## 0316 Beam trammel



### Specification

- With interchangeable steel points
- Stainless steel
- Locking screw
- Fine adjustment
- Factory standard

### Shipment

- Cardboard box

⏏	📄	Measuring range mm	Measuring beam mm	Reading mm	Ref. No.	List price Euro
		500	25 x 6	0.1	0316 201	130.00
		1000	25 x 6	0.1	0316 202	180.00

## Pair of replacement points, threaded



### Specification

- Thread M5

⏏	📄	Material	Diameter mm	Ref. No.	List price Euro
		Hardened	6	0316 110	7.10
		Carbide	6	0316 111	28.00

## 0316 Beam trammel with roller



**Jean Louis MENEGON** - Votre représentant et Conseiller- Tél. : 06 76 08 96 83  
E-mail: [jlouismenegon@aol.com](mailto:jlouismenegon@aol.com) - web: [www.menegon-metrologie.com](http://www.menegon-metrologie.com)

### Specification

- Flat beam
- Special steel
- Locking screw
- Fine adjustment
- Factory standard

### Shipment

- Cardboard box or transportation box\*

⏏	📄	Measuring range mm	Measuring beam mm	Reading mm	Ref. No.	List price Euro
		500	25 x 6	0.1	0316 151	115.00
		1000	25 x 6	0.1	0316 152	145.00
	▪	1500	25 x 6	0.1	0316 153	175.00
	▪	2000*	25 x 6	0.1	0316 154	225.00







## 0317 Beam compass with round measuring beam

**Specification**

- Beam is made of special steel
- Guide groove
- Slide bars are made of aluminium
- mm graduation
- Locking screws
- Interchangeable hardened scribers
- Factory standard



**Shipment**

- Cardboard box or transportation box\*

		Measuring range mm	Measuring beam dia. mm	Reading mm	Ref. No.	List price Euro
<b>Without fine adjustment</b>						
		500	20	0.1	0317 001	60.00
		1000	20	0.1	0317 002	85.00
	▪	1500	20	0.1	0317 003	110.00
	▪	2000*	20	0.1	0317 004	150.00
	▪	3000*	28	0.1	0317 005	346.00
	▪	4000*	28	0.1	0317 006	562.00
	▪	5000*	28	0.1	0317 007	750.00
<b>With fine adjustment</b>						
		500	20	0.1	0317 101	72.00
		1000	20	0.1	0317 102	97.00
	▪	1500	20	0.1	0317 103	125.00
	▪	2000*	20	0.1	0317 104	163.00
	▪	3000*	28	0.1	0317 105	376.00
	▪	4000*	28	0.1	0317 106	592.00
	▪	5000*	28	0.1	0317 107	780.00

## Pair of replacement points (clamp)



		Material	Diameter mm	Ref. No.	List price Euro
		Hardened	6	0317 010	7.50
		Carbide tipped	6	0317 110	22.10

Jean Louis MENEGON - Votre représentant et Conseiller- Tél. : 06 76 08 96 83

E-mail: [jlouismenegon@aol.com](mailto:jlouismenegon@aol.com) - web: [www.menegon-metrologie.com](http://www.menegon-metrologie.com)



0314 Marking calipers



Specification

- Special steel
- Locking screw
- Laser graduated scale
- Factory standard

Shipment

- Cardboard box

Icon 1	Icon 2	Measuring range		Jaw length mm	Reading mm	Ref. No.	List price Euro
		mm	dia.				
<b>With hardened scribing tips</b>							
		150	300	40	0.1	0314 002	71.00
		200	400	40	0.1	0314 003	81.00
		250	500	40	0.1	0314 004	85.00
		300	600	40	0.1	0314 005	90.00
<b>Carbide scribing tips</b>							
		150	300	40	0.1	0314 102	108.00
		200	400	40	0.1	0314 103	128.00
		250	500	40	0.1	0314 104	132.00
		300	600	40	0.1	0314 105	137.00

0308 Combined internal / external calipers



Specification

- Internal and external caliper
- Stainless steel
- Satin chrome finished scale
- With a rivetted hinge
- mm graduation for internal and external measurement

Shipment

- Cardboard box

Icon 1	Icon 2	Measuring range		Total length mm	Ref. No.	List price Euro
		mm	mm			
		120	190	190	0308 201	87.00
		160	250	250	0308 202	104.00
		200	310	310	0308 303	127.00
		300	460	460	0308 305	150.00

Jean Louis MENEGON - Votre représentant et Conseiller- Tél. : 06 76 08 96 83  
E-mail: [jlouismenegon@aol.com](mailto:jlouismenegon@aol.com) - web: [www.menegon-metrologie.com](http://www.menegon-metrologie.com)



### 0303 Precision internal calipers





#### Specification

- With a rivetted hinge
- Special steel
- Hardened measuring points

#### Shipment

- Cardboard box or transportation box\*

		Length mm	Ref. No.	List price Euro
		150	0303 001	6.50
		175	0303 002	7.10
		200	0303 003	8.10
		250	0303 004	8.70
		300	0303 005	9.90
		400	0303 006	12.10
		500	0303 007	15.00
		600	0303 008	22.70
		800	0303 009	32.70
		1000	0303 010	60.00
	▪	1200	0303 012	525.00
	▪	1500	0303 015	557.00
	▪	2000*	0303 020	594.00

### 0304 Precision external calipers





#### Specification

- With a rivetted hinge
- Special steel
- Hardened measuring points

#### Shipment

- Cardboard box or transportation box\*

		Length mm	Ref. No.	List price Euro
		150	0304 001	6.50
		175	0304 002	7.10
		200	0304 003	8.10
		250	0304 004	8.70
		300	0304 005	9.90
		400	0304 006	12.10
		500	0304 007	15.00
		600	0304 008	22.70
		800	0304 009	32.70
		1000	0304 010	60.00
	▪	1200	0304 012	525.00
	▪	1500	0304 015	557.00
	▪	2000*	0304 020	594.00

Jean Louis MENEGON - Votre représentant et Conseiller- Tél. : 06 76 08 96 83

E-mail: [jlouismenegon@aol.com](mailto:jlouismenegon@aol.com) - web: [www.menegon-metrologie.com](http://www.menegon-metrologie.com)





0312 Spring internal calipers





Specification

- Internal caliper with quick release set screw
- Special steel
- Quick release set screw and spring are burnished

Shipment

- Cardboard box

		Length mm	Ref. No.	List price Euro
		100	0312 101	3.20
		150	0312 103	4.50
		200	0312 105	5.50
		250	0312 107	6.70
		300	0312 108	8.10

0313 Spring external calipers



Specification

- External caliper with quick release set screw
- Special steel
- Quick release set screw and spring are burnished

Shipment

- Cardboard box

		Length mm	Ref. No.	List price Euro
		100	0313 101	3.20
		150	0313 103	4.50
		200	0313 105	5.50
		250	0313 107	6.70
		300	0313 108	8.10

Jean Louis MENEGON - Votre représentant et Conseiller- Tél. : 06 76 08 96 83  
 E-mail: [jlouismenegon@aol.com](mailto:jlouismenegon@aol.com) - web: [www.menegon-metrologie.com](http://www.menegon-metrologie.com)



### 0343 Marking calipers

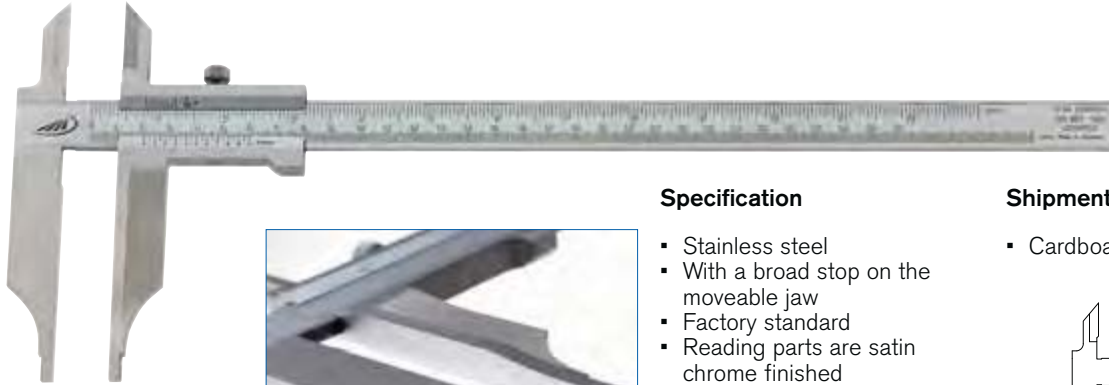

#### Specification

- Stainless steel
- With a broad stop on the moveable jaw
- Factory standard
- Reading parts are satin chrome finished
- Hardened measuring faces
- Knife points
- Locking screw
- Stop plate 9 mm

#### Shipment

- Cardboard box

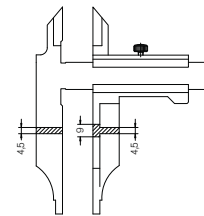

		Measuring range mm	Jaw length mm	Reading mm	Stepped jaws for inside measurement / mm	Ref. No.	List price Euro
		250	90	0.05	10	0343 501	245.00
		300	90	0.05	10	0343 503	276.00

### 0344 Marking calipers



**Jean Louis MENEGON** - Votre représentant et Conseiller- Tél. : **06 76 08 96 83**  
 E-mail: [jlouismenegon@aol.com](mailto:jlouismenegon@aol.com) - web: [www.menegon-metrologie.com](http://www.menegon-metrologie.com)



#### Specification

- Stainless steel, hardened
- Long T-shaped marking edge
- Factory standard
- Reading parts are satin chrome finished
- Low set master scale
- Fine adjustment
- Locking screw

#### Shipment

- Cardboard box

		Measuring range mm	Stop length mm	Reading mm	Ref. No.	List price Euro
		160	135	0.05	0344 501	120.00
		250	135	0.05	0344 502	153.00
		300	160	0.05	0344 503	194.00
		500	160	0.05	0344 505	412.00



0321 Marking gauge

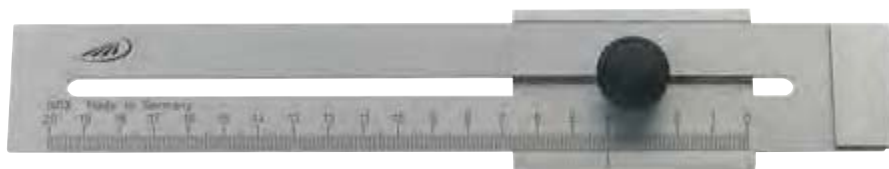

Specification

- Flat, stable construction
- Stainless steel, chrome finished
- Locking screw
- Hardened stop face
- mm graduated scale
- Factory standard

Shipment

- Cardboard box

		Measuring range mm	Blade width mm	Reading mm	Ref. No.	List price Euro
		200	40	1/1	0321 301	21.00
		250	40	1/1	0321 302	23.50
		300	40	1/1	0321 303	24.00
		500	40	1/1	0321 305	45.50

Jean Louis MENEGON - Votre représentant et Conseiller- Tél. : 06 76 08 96 83

E-mail: [jlouismenegon@aol.com](mailto:jlouismenegon@aol.com) - web: [www.menegon-metrologie.com](http://www.menegon-metrologie.com)

0323 Marking gauge



Specification

- Stainless steel
- Locking screw
- For marking by scale as well as for marking of 45°- or 90°- mitres
- mm-graduation
- Factory standard

Shipment

- Cardboard box

		Measuring range mm	Blade width mm	Reading mm	Ref. No.	List price Euro
		100	40	1/1	0323 308	15.60
		200	40	1/1	0323 318	19.90



Jean Louis MENEGON - Votre représentant et Conseiller- Tél. : 06 76 08 96 83  
E-mail: [jlouismenegon@aol.com](mailto:jlouismenegon@aol.com) - web: [www.menegon-metrologie.com](http://www.menegon-metrologie.com)

### 0318 Marking gauges



#### Specification

- Stainless steel
- Hardened stop face
- Interchangeable scriber
- Factory standard

#### Shipment

- Cardboard box



⌘	⚡	Measuring range mm	Length of stop bar mm	Reading mm	Ref. No.	List price Euro
		200	130	0.05	0318 201	142.00
		300	130	0.05	0318 203	151.00

### Replacement scribers



⌘	⚡	Material	Ref. No.	List price Euro
		Special steel	0318 210	12.00
		Carbide tipped	0318 211	39.00

### 0322 Marking gauges with guide roll



#### Specification

- Stainless steel, hardened
- Reading parts are satin chrome finished
- Guide roll
- Locking screw
- Interchangeable scriber made of hardened steel
- Factory standard

#### Shipment

- Cardboard box



⌘	⚡	Measuring range mm	Reading mm	Ref.-No.	List price Euro
		200	0.05	0322 501	24.00
		400	0.05	0322 503	37.50

#### Accessories

	Ref.-No.	List price Euro
Replacement scriber	0322 510	4.20



0319 Marking gauges with a round measuring beam



Jean Louis MENEGON - Votre représentant et Conseiller- Tél. : 06 76 08 96 83  
 E-mail: [jlouismenegon@aol.com](mailto:jlouismenegon@aol.com) - web: [www.menegon-metrologie.com](http://www.menegon-metrologie.com)



**Specification**

- With guide groove
- Stainless steel beam
- Slide bars are made of steel, rectangular stop plate

**Shipment**

- Scriber interchangeable, made of hardened steel
- mm graduation
- Factory standard
- Cardboard box

		Measuring range mm	Measuring beam dia. mm	Reading mm	Ref. No.	List price Euro
<b>Without fine adjustment</b>						
		200	12	0.1	0319 001	34.00
		300	12	0.1	0319 002	42.50
		400	12	0.1	0319 003	61.00
		500	12	0.1	0319 004	82.00
<b>With fine adjustment</b>						
		200	12	0.1	0319 101	43.50
		300	12	0.1	0319 102	51.00
		400	12	0.1	0319 103	70.00
		500	12	0.1	0319 104	89.00

4

0320 Marking gauges with a round measuring beam



**Specification**

- With guide groove
- Stainless steel beam
- Slide bars are made of steel, round stop plate
- Interchangeable scriber made of hardened steel
- mm graduation

**Shipment**

- Cardboard box

		Measuring range mm	Measuring beam dia. mm	Reading mm	Ref. No.	List price Euro
<b>Without fine adjustment</b>						
		300	12	0.1	0320 001	42.50
		500	12	0.1	0320 002	82.00
<b>With fine adjustment</b>						
		300	12	0.1	0320 101	66.00
		500	12	0.1	0320 102	104.00

Replacement scribes



		Material	Ref. No.	List price Euro
		Hardened steel	0319 010	3.60
		Carbide	0319 510	37.00





### 0345 / 0347 Analogue height and scribing gauges



#### Specification

- Measuring beam is made from special steel
- Vernier and scale are satin chrome finished
- Parallax-free reading
- Setting screw
- Fine adjustment
- Accurate fine adjustment on gear rack and setting wheel with pinion
- Steel base with dirt grooves
- Scribing possible from base plate level
- Factory standard

#### Shipment

- With exchangeable scriber, carbide tipped



Accurate fine adjustment on gear rack

		Measuring range mm	Measuring beam mm	Base mm	Reading mm	Ref. No.	List price Euro
<b>With fine adjustment</b>							
		300	30 x 12	145 x 90 x 44	0.02	0345 522	359.00
		600	30 x 12	189 x 118 x 44	0.02	0345 530	449.00
		1000	30 x 12	189 x 118 x 44	0.02	0345 534	619.00
<b>With pinion</b>							
		300	30 x 12	145 x 90 x 44	0.02	0347 522	459.00
		600	30 x 12	189 x 118 x 44	0.02	0347 530	579.00
		1000	30 x 12	189 x 118 x 44	0.02	0347 534	799.00

### Replacement scribers for 0345 / 0347



#### Specification

- Carbide tipped
- Packing: individually packed

		Length mm	Ref. No.	List price Euro
		75	0345 910	115.00
		150	0345 912	127.00

Jean Louis MENEGON - Votre représentant et Conseiller- Tél. : 06 76 08 96 83  
 E-mail: [jlouismenegon@aol.com](mailto:jlouismenegon@aol.com) - web: [www.menegon-metrologie.com](http://www.menegon-metrologie.com)



0345 / 0347 DIGI-MET® Height and scribing gauges



Available from autumn 2015

**Specification**

- Measuring beam is made from special steel
- LCD-display 11 mm
- Setting screw
- Fine adjustment
- Accurate fine adjustment on gear rack and setting wheel with pinion
- Steel base with dirt grooves
- Scribing possible from base plate level
- Factory standard

**Electronic functions**

- ON/OFF switch
- Zero setting at any position
- mm/inch conversion
- Hold Function
- Data output RS 232 Proximity
- PRESET Function (setting a numerical value)

**Shipment**

- With exchangeable scriber, carbide tipped

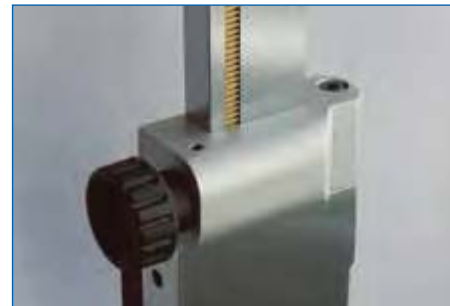

Accurate fine adjustment on gear rack

		Measuring range mm	Measuring beam mm	Base mm	Reading mm	Ref. No.	List price Euro
<b>With fine adjustment</b>							
		300	30 x 12	145 x 90 x 44	0.01	0345 722	519.00
		600	30 x 12	189 x 118 x 44	0.01	0345 730	649.00
		1000	30 x 12	189 x 118 x 44	0.01	0345 734	899.00
<b>With pinion</b>							
		300	30 x 12	145 x 90 x 44	0.01	0347 722	639.00
		600	30 x 12	189 x 118 x 44	0.01	0347 730	799.00
		1000	30 x 12	189 x 118 x 44	0.01	0347 734	1,099.00

Replacement scribers for 0345 / 0347



**Specification**

- Carbide tipped
- Packing: individually packed

		Length mm	Ref. No.	List price Euro
		75	0345 910	115.00
		150	0345 912	127.00

Jean Louis MENEGON - Votre représentant et Conseiller- Tél. : 06 76 08 96 83

E-mail: [jlouismenegon@aol.com](mailto:jlouismenegon@aol.com) - web: [www.menegon-metrologie.com](http://www.menegon-metrologie.com)

	Ref. No.	List price Euro
Battery, 3V-Lithium, CR 2032	0220 704	3.60
Cable RS 232 Proximity	0997 772	232.00



## 0349 DIGI-MET® Height gauge with sliding scriber

**NEW**

Available from autumn 2015

**Specification**

- Measuring beam is made from special steel
- LCD-display 11 mm
- Fine adjustment
- Setting screw
- Steel base with dirt grooves
- Scribing possible from base plate level
- Factory standard

**Shipment**

- With exchangeable, straight scriber made from hardened steel

**Electronic functions**

- ON/OFF switch
- Zero setting at any position
- mm/inch conversion
- Data output RS 232 Proximity
- Hold Function
- PRESET Function (setting a numerical value)

⏏	📏	Measuring range mm	Measuring beam mm	Base mm	Reading mm	Ref. No.	List price Euro
		300	30 x 12	145 x 90 x 44	0.01	0349 722	549.00
		600	30 x 12	189 x 118 x 44	0.01	0349 730	699.00
		1000	30 x 12	189 x 118 x 44	0.01	0349 734	949.00

## Replacement scribers for 0349

⏏	📏	Material	Length mm	Shaft mm	Ref. No.	List price Euro
<b>Straight scriber</b>						
		Hardened tip	270	8 x 8	0349 910	105.00
		Carbide tip	270	8 x 8	0349 914	137.00
<b>Cranked scriber, for marking operations from base</b>						
		Hardened tip	270	8 x 8	0349 912	123.00
		Carbide tip	270	8 x 8	0349 916	156.00

**Accessories**

	Ref. No.	List price Euro
Battery, 3V-Lithium, CR 2032	0220 704	3.60
Cable RS 232 Proximity	0997 772	232.00

Jean Louis MENEGON - Votre représentant et Conseiller- Tél. : 06 76 08 96 83

E-mail: [jlouismenegon@aol.com](mailto:jlouismenegon@aol.com) - web: [www.menegon-metrologie.com](http://www.menegon-metrologie.com)



## Replacement scribers for height gauges not any longer included in our catalogue



Ref. No. Scriber	Ref. No. Height gauge						Specification	Length mm	Shaft mm	List price Euro
	0330...	0331...	0336...	0338...	0340...	0342...				
0331 011		●		●			straight, hardened steel	270	8 x 8	105.00
0331 030		●					cranked, hardened steel	270	8 x 8	123.00
0331 111		●		●			straight, carbide tipped	270	8 x 8	137.00
0331 130		●					cranked, carbide tipped	270	8 x 8	156.00
0334 101	●		●		●	●	straight, carbide tipped	65	8 x 8	69.00
0334 102	●		●		●	●	straight, carbide tipped	75	-	115.00
0334 105			●				straight, carbide tipped	120	-	84.00
0334 106			●				straight, carbide tipped	150	-	127.00
0338 354				●			cranked, hardened steel	270	8 x 8	135.00
0338 357				●			cranked, carbide tipped	270	8 x 8	175.00



[www.menegon-metrologie.com](http://www.menegon-metrologie.com)

## **EVEN FOR SMALL QUANTITIES WE GET STARTED RIGHT AWAY ...**

Because we produce in-house, so we don't have far to go. Our decisions are not based on when and who can do what in Asia; instead, we look at what we can do here in Gammertingen, Germany.

As well as the resulting flexibility, this offers another very significant benefit for our customers: even if what you need is complicated, we can say yes to your request. For example, if you're needing to push the limits of manual measurement technology, you will benefit from our almost unlimited knowledge.

Advise, test, solve: even if custom-made products are necessary, there is one thing you can always rely on: we can do it for you! Because with experience, expertise, team spirit and modern machinery, our professionals are there for you to serve your professional needs. Strictly speaking, this is all that high-quality portable measuring technology really needs, which is why this is exactly what we focus on.



**Jean Louis MENEGON** - Votre représentant et Conseiller- Tél. : 06 76 08 96 83  
E-mail: [jlouismenegon@aol.com](mailto:jlouismenegon@aol.com) - web: [www.menegon-metrologie.com](http://www.menegon-metrologie.com)

## 5. KAPITEL SQUARES, PROTRACTORS AND BEVEL PROTRACTORS

190	Squares with / without base
194	Steel squares
195	Squares with hard and slim blade
196	Knife edge squares
197	Pattern maker angle
199	Inspection set
200	Mitre / Acute angle and Centre squares
202	Squares for specific measuring tasks and target groups
205	Wooden cases
206	Protractors
209	Universal bevel protractors
211	Protractor „Pernumeter“





Jean Louis MENEGON - Votre représentant et Conseiller- Tél. : 06 76 08 96 83

E-mail: [jlouismenegon@aol.com](mailto:jlouismenegon@aol.com) - web: [www.menegon-metrologie.com](http://www.menegon-metrologie.com)

## 0368 Squares with base accuracy grade 0



**DIN  
875**



### Specification

- DIN 875
- Accuracy grade 0
- For exact angle testing (for example: tool making)

### Shipment

- Cardboard box
- From blade length 1000 mm in a transportation box



		Blade length mm	Cross section mm	Ref. No.	List price Euro
<b>Special steel</b>					
		75 x 50	15 x 5	0368 102	14.80
		100 x 70	20 x 5	0368 103	17.20
		150 x 100	25 x 5	0368 104	26.10
		200 x 130	30 x 6	0368 105	33.40
		250 x 165	35 x 7	0368 106	48.30
		300 x 200	40 x 8	0368 107	65.00
		400 x 265	45 x 10	0368 108	142.00
		500 x 330	50 x 10	0368 109	208.00
		600 x 400	50 x 10	0368 110	297.00
		750 x 500	60 x 12	0368 111	508.00
	▪	1000 x 660	70 x 15	0368 112	911.00
<b>Stainless steel</b>					
		75 x 50	15 x 5	0368 202	22.10
		100 x 70	20 x 5	0368 203	23.90
		150 x 100	25 x 5	0368 204	41.00
		200 x 130	30 x 6	0368 205	59.00
		250 x 165	35 x 7	0368 206	86.00
		300 x 200	40 x 8	0368 207	96.00
		400 x 265	45 x 10	0368 208	180.00
		500 x 330	50 x 10	0368 209	249.00
		600 x 400	50 x 10	0368 210	371.00
		750 x 500	60 x 12	0368 211	636.00
	▪	1000 x 660	70 x 15	0368 212	1,350.00

## 0369 Squares without base accuracy grade 0



**DIN  
875**



### Specification

- DIN 875
- Accuracy grade 0
- For exact angle testing (for example: tool making)

### Shipment

- Cardboard box
- From blade length 1000 mm in a transportation box



		Blade length mm	Cross section mm	Ref. No.	List price Euro
<b>Special steel</b>					
		75 x 50	15 x 5	0369 102	9.70
		100 x 70	20 x 5	0369 103	10.90
		150 x 100	25 x 5	0369 104	13.40
		200 x 130	30 x 6	0369 105	22.10
		250 x 165	35 x 7	0369 106	30.60
		300 x 200	40 x 8	0369 107	39.30
		400 x 265	45 x 10	0369 108	96.00
		500 x 330	50 x 10	0369 109	118.00
		600 x 400	50 x 10	0369 110	234.00
		750 x 500	60 x 12	0369 111	434.00
	▪	1000 x 660	70 x 15	0369 112	774.00
<b>Stainless steel</b>					
		75 x 50	15 x 5	0369 202	16.10
		100 x 70	20 x 5	0369 203	17.60
		150 x 100	25 x 5	0369 204	23.40
		200 x 130	30 x 6	0369 205	35.40
		250 x 165	35 x 7	0369 206	47.10
		300 x 200	40 x 8	0369 207	65.00
		400 x 265	45 x 10	0369 208	125.00
		500 x 330	50 x 10	0369 209	173.00
		600 x 400	50 x 10	0369 210	291.00
		750 x 500	60 x 12	0369 211	543.00
	▪	1000 x 660	70 x 15	0369 212	1,019.00



**0385 Inspection squares with base accuracy grade 0, hardened**



**Specification**

- DIN 875
- Accuracy grade 0
- For exact angle testing (for example: tool making)

**Shipment**

- Cardboard box



**DIN 875**

		Blade length mm	Cross section mm	Ref. No.	List price Euro
<b>Special steel</b>					
		50 x 40	15 x 4	0385 102	23.40
		75 x 50	15 x 4	0385 103	24.90
		100 x 70	20 x 5	0385 104	29.80
		150 x 100	25 x 6	0385 105	44.60
		200 x 130	30 x 7	0385 106	62.00
		300 x 200	40 x 8	0385 108	108.00
<b>Stainless steel</b>					
		50 x 40	15 x 4	0385 202	32.40
		75 x 50	15 x 4	0385 203	36.00
		100 x 70	20 x 5	0385 204	44.60
		150 x 100	25 x 6	0385 205	59.00
		200 x 130	30 x 7	0385 206	76.00
		300 x 200	40 x 8	0385 208	112.00

**0386 Inspection squares without base accuracy grade 0, hardened**



**Specification**

- DIN 875
- Accuracy grade 0
- For exact angle testing (for example: tool making)

**Shipment**

- Cardboard box



**DIN 875**

		Blade length mm	Cross section mm	Ref. No.	List price Euro
<b>Special steel</b>					
		50 x 40	15 x 4	0386 102	17.60
		75 x 50	15 x 4	0386 103	19.00
		100 x 70	20 x 5	0386 104	23.20
		150 x 100	25 x 6	0386 105	28.70
		200 x 130	30 x 7	0386 106	37.10
		300 x 200	40 x 8	0386 108	71.00
<b>Stainless steel</b>					
		50 x 40	15 x 4	0386 202	22.30
		75 x 50	15 x 4	0386 203	25.30
		100 x 70	20 x 5	0386 204	29.80
		150 x 100	25 x 6	0386 205	38.70
		200 x 130	30 x 7	0386 206	50.00
		300 x 200	40 x 8	0386 208	99.00

Jean Louis MENEGON - Votre représentant et Conseiller- Tél. : 06 76 08 96 83

E-mail: [jlouismenegon@aol.com](mailto:jlouismenegon@aol.com) - web: [www.menegon-metrologie.com](http://www.menegon-metrologie.com)





Jean Louis MENEGON - Votre représentant et Conseiller- Tél. : 06 76 08 96 83

E-mail: [jlouismenegon@aol.com](mailto:jlouismenegon@aol.com) - web: [www.menegon-metrologie.com](http://www.menegon-metrologie.com)

## 0370 Squares with base accuracy grade 1





### Specification

- DIN 875
- Accuracy grade 1
- For angle testing in production and factory

### Shipment

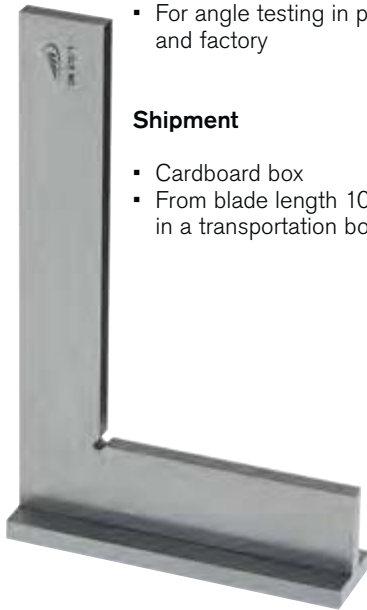
- Cardboard box
- From blade length 1000 mm in a transportation box



		Blade length mm	Cross section mm	Ref. No.	List price Euro
<b>Special steel</b>					
		75 x 50	15 x 5	0370 102	9.40
		100 x 70	20 x 5	0370 103	10.50
		150 x 100	25 x 5	0370 104	10.70
		200 x 130	30 x 6	0370 105	17.40
		250 x 165	35 x 7	0370 106	23.20
		300 x 200	40 x 8	0370 107	28.30
		400 x 265	45 x 10	0370 108	77.00
		500 x 330	50 x 10	0370 109	113.00
		600 x 400	50 x 10	0370 110	158.00
		750 x 500	60 x 12	0370 111	353.00
	▪	1000 x 660	70 x 15	0370 112	598.00
<b>Stainless steel</b>					
		75 x 50	15 x 5	0370 202	13.00
		100 x 70	20 x 5	0370 203	15.80
		150 x 100	25 x 5	0370 204	21.60
		200 x 130	30 x 6	0370 205	28.70
		250 x 165	35 x 7	0370 206	43.10
		300 x 200	40 x 8	0370 207	52.00
		400 x 265	45 x 10	0370 208	155.00
		500 x 330	50 x 10	0370 209	191.00
		600 x 400	50 x 10	0370 210	323.00
		750 x 500	60 x 12	0370 211	500.00
	▪	1000 x 660	70 x 15	0370 212	809.00

## 0371 Squares without base accuracy grade 1





### Specification

- DIN 875
- Accuracy grade 1
- For angle testing in production and factory

### Shipment

- Cardboard box
- From blade length 1000 mm in a transportation box



		Blade length mm	Cross section mm	Ref. No.	List price Euro
<b>Special steel</b>					
		75 x 50	15 x 5	0371 102	7.10
		100 x 70	20 x 5	0371 103	7.50
		150 x 100	25 x 5	0371 104	9.00
		200 x 130	30 x 6	0371 105	12.30
		250 x 165	35 x 7	0371 106	18.70
		300 x 200	40 x 8	0371 107	22.10
		400 x 265	45 x 10	0371 108	56.00
		500 x 330	50 x 10	0371 109	79.00
		600 x 400	50 x 10	0371 110	109.00
		750 x 500	60 x 12	0371 111	241.00
	▪	1000 x 660	70 x 15	0371 112	413.00
<b>Stainless steel</b>					
		75 x 50	15 x 5	0371 202	8.70
		100 x 70	20 x 5	0371 203	10.50
		150 x 100	25 x 5	0371 204	14.80
		200 x 130	30 x 6	0371 205	20.50
		250 x 165	35 x 7	0371 206	29.80
		300 x 200	40 x 8	0371 207	36.40
		400 x 265	45 x 10	0371 208	120.00
		500 x 330	50 x 10	0371 209	150.00
		600 x 400	50 x 10	0371 210	248.00
		750 x 500	60 x 12	0371 211	455.00
	▪	1000 x 660	70 x 15	0371 212	734.00





0372 Squares with base accuracy grade 2



Specification

- Special steel
- DIN 875
- Accuracy grade 2
- For angle testing in factory and metal construction

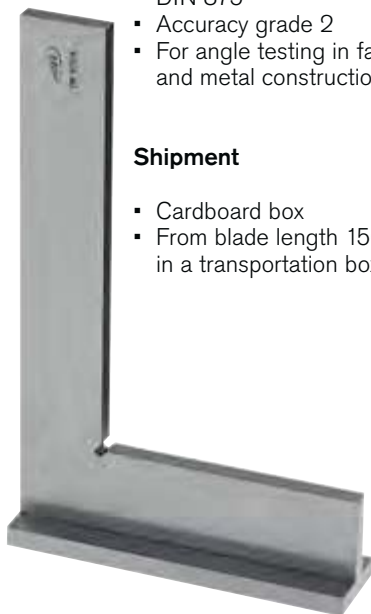

Shipment

- Cardboard box
- From blade length 1500 mm in a transportation box

DIN 875

		Blade length mm	Cross section mm	Ref. No.	List price Euro
		75 x 50	15 x 5	0372 102	7.30
		100 x 70	20 x 5	0372 103	8.20
		150 x 100	25 x 5	0372 104	10.70
		200 x 130	30 x 6	0372 105	13.70
		250 x 165	35 x 7	0372 106	18.60
		300 x 175	35 x 7	0372 107	23.40
		400 x 200	35 x 7	0372 108	39.30
		500 x 250	40 x 8	0372 109	52.00
		600 x 300	40 x 8	0372 110	70.00
		750 x 375	45 x 10	0372 111	89.00
		1000 x 500	50 x 10	0372 112	122.00
	▪	1500 x 750	60 x 12	0372 113	438.00
	▪	2000 x 1000	60 x 12	0372 114	705.00

0373 Squares without base accuracy grade 2



Specification

- Special steel
- DIN 875
- Accuracy grade 2
- For angle testing in factory and metal construction

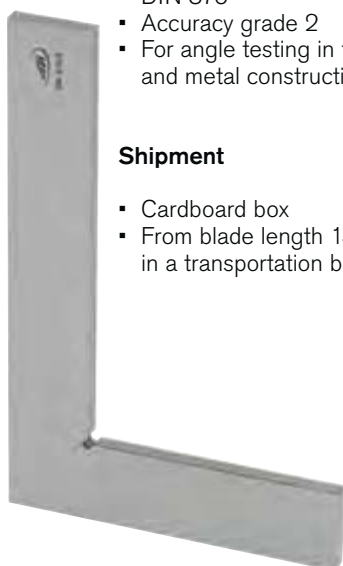

Shipment

- Cardboard box
- From blade length 1500 mm in a transportation box

DIN 875

		Blade length mm	Cross section mm	Ref. No.	List price Euro
		75 x 50	15 x 5	0373 102	5.20
		100 x 70	20 x 5	0373 103	6.00
		150 x 100	25 x 5	0373 104	8.20
		200 x 130	30 x 6	0373 105	9.90
		250 x 165	35 x 7	0373 106	13.70
		300 x 175	35 x 7	0373 107	17.50
		400 x 200	35 x 7	0373 108	26.40
		500 x 250	40 x 8	0373 109	38.60
		600 x 300	40 x 8	0373 110	52.00
		750 x 375	45 x 10	0373 111	69.00
		1000 x 500	50 x 10	0373 112	101.00
	▪	1500 x 750	60 x 12	0373 113	336.00
	▪	2000 x 1000	60 x 12	0373 114	620.00

Jean Louis MENEGON - Votre représentant et Conseiller- Tél. : 06 76 08 96 83  
E-mail: [jlouismenegon@aol.com](mailto:jlouismenegon@aol.com) - web: [www.menegon-metrologie.com](http://www.menegon-metrologie.com)



## 0374 Steel squares with base



### Specification

- Special steel, zinc coated
- Factory standard
- Simple design for angle tests in steel and metal construction

### Shipment

- Cardboard box
- From blade length 1500 mm in a transportation box

✂	🏠	Blade length mm	Cross section mm	Ref. No.	List price Euro
		100 x 70	20 x 5	0374 404	5.90
		150 x 100	20 x 5	0374 408	6.70
		200 x 130	20 x 5	0374 410	8.10
		250 x 160	25 x 5	0374 412	9.90
		300 x 180	25 x 5	0374 414	11.90
		400 x 230	30 x 5	0374 416	15.00
		500 x 280	30 x 5	0374 418	20.00
		600 x 330	30 x 5	0374 420	27.00
		750 x 375	30 x 5	0374 424	32.00
		1000 x 500	30 x 5	0374 428	49.00
	▪	1500 x 750	40 x 5	0374 430*	170.00
	▪	2000 x 1000	40 x 5	0374 432*	250.00

\*polished

## 0375 Steel squares without base



### Specification

- Special steel, zinc coated
- Factory standard
- Simple design for angle tests in steel and metal construction

### Shipment

- Cardboard box
- From blade length 1500 mm in a transportation box

✂	🏠	Blade length mm	Cross section mm	Ref. No.	List price Euro
		100 x 70	20 x 5	0375 404	4.70
		150 x 100	20 x 5	0375 408	4.90
		200 x 130	20 x 5	0375 410	5.30
		250 x 160	25 x 5	0375 412	6.40
		300 x 180	25 x 5	0375 414	7.00
		400 x 230	30 x 5	0375 416	9.60
		500 x 280	30 x 5	0375 418	10.60
		600 x 330	30 x 5	0375 420	13.00
		750 x 375	30 x 5	0375 424	15.50
		1000 x 500	30 x 5	0375 428	20.00
	▪	1500 x 750	40 x 5	0375 430*	80.00
	▪	2000 x 1000	40 x 5	0375 432*	120.00

\*polished

Jean Louis MENEGON - Votre représentant et Conseiller- Tél. : 06 76 08 96 83

E-mail: [jlouismenegon@aol.com](mailto:jlouismenegon@aol.com) - web: [www.menegon-metrologie.com](http://www.menegon-metrologie.com)



0376 Squares with hard and slim blade, accuracy grade 1



Specification

- Special steel
- DIN 875
- Accuracy grade 1
- For angle testing in production and factory

Shipment

- Cardboard box

DIN 875

⌘	📏	Blade length mm	Hard blade mm	Slim blade mm	Ref. No.	List price Euro
		75 x 50	14 x 10	14 x 2	0376 102	11.40
		100 x 70	16 x 10	16 x 3	0376 103	12.10
		150 x 100	20 x 12	22 x 3	0376 104	15.20
		200 x 130	24 x 14	24 x 3	0376 105	25.00

0376 Squares with hard and slim blade, accuracy grade 2

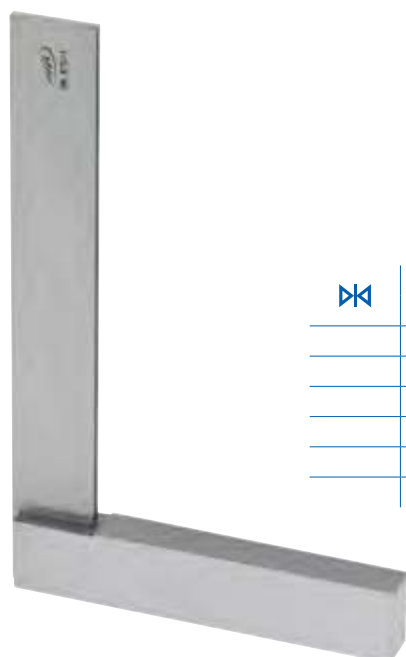

Specification

- Special steel
- DIN 875
- Accuracy grade 2
- For angle tests in the workshop and metal construction

Shipment

- Cardboard box

DIN 875

⌘	📏	Blade length mm	Hard blade mm	Slim blade mm	Ref. No.	List price Euro
		75 x 50	14 x 10	14 x 2	0376 112	10.60
		100 x 70	16 x 10	18 x 2	0376 113	11.30
		150 x 100	20 x 12	22 x 3	0376 114	13.70
		200 x 130	24 x 14	24 x 3	0376 115	19.20
		250 x 160	28 x 16	28 x 3	0376 116	23.70
		300 x 175	32 x 18	30 x 3	0376 117	28.20

5



**0390 Squares with hard and slim blade, hardened, accuracy grade 0**



**Specification**

**Shipment**

**DIN 875**

- DIN 875
- Accuracy grade 0
- For exact angle testing (for example: tool making)

- Cardboard box



⊠	⊠	Blade length mm	Hard blade mm	Slim blade mm	Ref. No.	List price Euro
<b>Special steel</b>						
		50 x 40	14 x 10	16 x 2	0390 102	33.40
		75 x 50	14 x 10	18 x 2	0390 103	33.40
		100 x 70	16 x 10	18 x 2	0390 104	38.70
		150 x 100	20 x 12	22 x 3	0390 105	49.40
		200 x 130	24 x 14	26 x 3	0390 106	66.00
		300 x 200	30 x 18	32 x 3	0390 108	112.00
<b>Stainless steel</b>						
		50 x 40	14 x 10	16 x 2	0390 202	44.30
		75 x 50	14 x 10	18 x 2	0390 203	50.00
		100 x 70	16 x 10	18 x 2	0390 204	64.00
		150 x 100	20 x 12	22 x 3	0390 205	82.00
		200 x 130	24 x 14	26 x 3	0390 206	103.00
		300 x 200	30 x 18	32 x 3	0390 208	158.00

**0391 Knife edge squares with hard and slim blade, hardened, accuracy grade 00**



**Specification**

**Shipment**

**DIN 875**

- With knife edge
- DIN 875
- Accuracy grade 00
- For exact flatness testing (for example: in production)

- Cardboard box



⊠	⊠	Blade length mm	Hard blade mm	Slim blade mm	Ref. No.	List price Euro
<b>Special steel, non-glare knife edge</b>						
		50 x 40	14 x 10	16 x 2	0391 102	52.00
		75 x 50	14 x 10	18 x 2	0391 103	52.00
		100 x 70	16 x 10	18 x 2	0391 104	67.00
		150 x 100	20 x 12	22 x 3	0391 105	85.00
		200 x 130	24 x 14	26 x 3	0391 106	115.00
		300 x 200	30 x 18	32 x 3	0391 108	167.00
<b>Stainless steel</b>						
		50 x 40	14 x 10	16 x 2	0391 202	62.00
		75 x 50	14 x 10	18 x 2	0391 203	69.00
		100 x 70	16 x 10	18 x 2	0391 204	79.00
		150 x 100	20 x 12	22 x 3	0391 205	101.00
		200 x 130	24 x 14	26 x 3	0391 206	129.00
		300 x 200	30 x 18	32 x 3	0391 208	210.00

Jean Louis MENEGON - Votre représentant et Conseiller- Tél. : 06 76 08 96 83

E-mail: [jlouismenegon@aol.com](mailto:jlouismenegon@aol.com) - web: [www.menegon-metrologie.com](http://www.menegon-metrologie.com)





0388 Knife edge squares, hardened, accuracy grade 00



Specification

- DIN 875
- Accuracy grade 00
- For exact angle and flatness testing (for example: tool making)

Shipment

- Cardboard box

DIN 875

		Blade length mm	Cross section mm	Ref. No.	List price Euro
<b>Special steel, non-glare knife edge</b>					
		50 x 40	14 x 4	0388 102	18.70
		75 x 50	15 x 4	0388 103	22.10
		100 x 70	20 x 5	0388 104	26.50
		150 x 100	25 x 6	0388 105	35.60
		200 x 130	30 x 7	0388 106	50.00
		300 x 200	40 x 8	0388 108	87.00
<b>Stainless steel</b>					
		50 x 40	14 x 4	0388 202	22.10
		75 x 50	15 x 4	0388 203	26.10
		100 x 70	20 x 5	0388 204	31.40
		150 x 100	25 x 6	0388 205	40.50
		200 x 130	30 x 7	0388 206	60.00
		300 x 200	40 x 8	0388 208	131.00
		500 x 330	40 x 10	0388 210	625.00

0394 Pattern maker angle, adjustable



Specification

- Reading parts are satin chrome finished
- Sliding knife edge 7 x 7 x 60 mm
- Handle 40 x 23 x 9 mm
- For tests at short grooves through the sliding straight edge

Shipment

- Wooden case

		Ref. No.	List price Euro
		0394 110	79.00



### 0394 Pattern maker angle, adjustable, hardened



#### Specification

- Satin chrome finished reading parts
- Sliding knife edge rule: 7 x 7 x 100 mm,
- Angle adjustable up to  $\pm 5^\circ$
- Handle 35 x 13 x 60 mm
- For testing on short edges and grooves through the sliding knife edge

#### Shipment

- Wooden case

		Ref. No.	List price Euro
		0394 101	195.00

### Replacement rule



	Ref. No.	List price Euro
Replacement rule for 0394	0394 104	35.40

Jean Louis MENEGON - Votre représentant et Conseiller- Tél. : 06 76 08 96 83  
 E-mail: [jlouismenegon@aol.com](mailto:jlouismenegon@aol.com) - web: [www.menegon-metrologie.com](http://www.menegon-metrologie.com)



0387 Knife edge squares, hardened, accuracy grade 00



Specification

- Stainless steel
- DIN 875
- Accuracy grade 00
- Angle 90°
- Knife edge on the inside

Shipment

- Cardboard box

DIN 875

			Blade length mm	Hard blade mm	Knife edge blade mm	Ref. No.	List price Euro
			25 x 20	6 x 3.5	5 x 3.5	0387 200	16.60
			40 x 28	8 x 3.5	5 x 3.5	0387 201	16.60

0387 Inspection square set



Set consists of:

- Knife edge squares 0387 200 and 0387 201
- Wooden case

	Ref. No.	List price Euro
Inspection square set	0387 204	38.70

0397 5 piece inspection set



Set consists of:

- Knife edge square, stainless steel 75 x 50 mm
- Knife edge square, stainless steel 40 x 28 mm
- Knife edge square, stainless steel 25 x 20 mm
- Knife edge rule, special steel 100 mm
- Gauge block scribe, 60 x 9 x 9 mm

Shipment

- Wooden case

			Ref. No.	List price Euro
			0397 101	170.00

5





## 0395 Mitre squares 135°



## Specification

- Special steel
- Factory standard

## Shipment

- Cardboard box



		Blade length mm	Cross section mm	Ref. No.	List price Euro
<b>With base</b>					
		120 x 80	20 x 5	0395 142	17.60
		150 x 100	20 x 5	0395 143	19.90
		200 x 130	25 x 5	0395 144	26.10
<b>Flat, without base</b>					
		50 x 50	15 x 5	0395 136	8.00
		75 x 75	18 x 5	0395 137	10.20
		100 x 100	20 x 5	0395 138	12.30
		120 x 80	20 x 5	0395 146	13.00
		150 x 100	20 x 5	0395 147	17.60
		200 x 130	25 x 5	0395 148	23.90

## 0395 Mitre squares 120°



## Specification

- Special steel
- Factory standard

## Shipment

- Cardboard box



		Blade length mm	Cross section mm	Ref. No.	List price Euro
<b>Flat, without base</b>					
		50 x 50	15 x 5	0395 132	8.00
		75 x 75	18 x 5	0395 133	10.20
		100 x 100	20 x 5	0395 134	12.30

Jean Louis MENEGON - Votre représentant et Conseiller- Tél. : 06 76 08 96 83

E-mail: [jlouismenegon@aol.com](mailto:jlouismenegon@aol.com) - web: [www.menegon-metrologie.com](http://www.menegon-metrologie.com)



## 0395 Acute angle squares 60°



### Specification

- Special steel
- Factory standard

### Shipment

- Cardboard box

		Blade length mm	Cross section mm	Ref. No.	List price Euro
<b>With base</b>					
		120 x 80	20 x 5	0395 122	24.40
		150 x 100	20 x 5	0395 123	28.00
		200 x 130	25 x 5	0395 124	37.50
<b>Flat, without base</b>					
		120 x 80	20 x 5	0395 126	17.50
		150 x 100	20 x 5	0395 127	19.50
		200 x 130	25 x 5	0395 128	27.50

## 0395 Acute angle squares 45°



### Specification

- Special steel
- Factory standard

### Shipment

- Cardboard box

		Blade length mm	Cross section mm	Ref. No.	List price Euro
<b>With base</b>					
		120 x 80	20 x 5	0395 102	25.90
		150 x 100	20 x 5	0395 103	28.70
		200 x 130	25 x 5	0395 104	38.70
<b>Flat, without base</b>					
		120 x 80	20 x 5	0395 106	18.20
		150 x 100	20 x 5	0395 107	19.90
		200 x 130	25 x 5	0395 108	28.70



## 0380 Centre squares

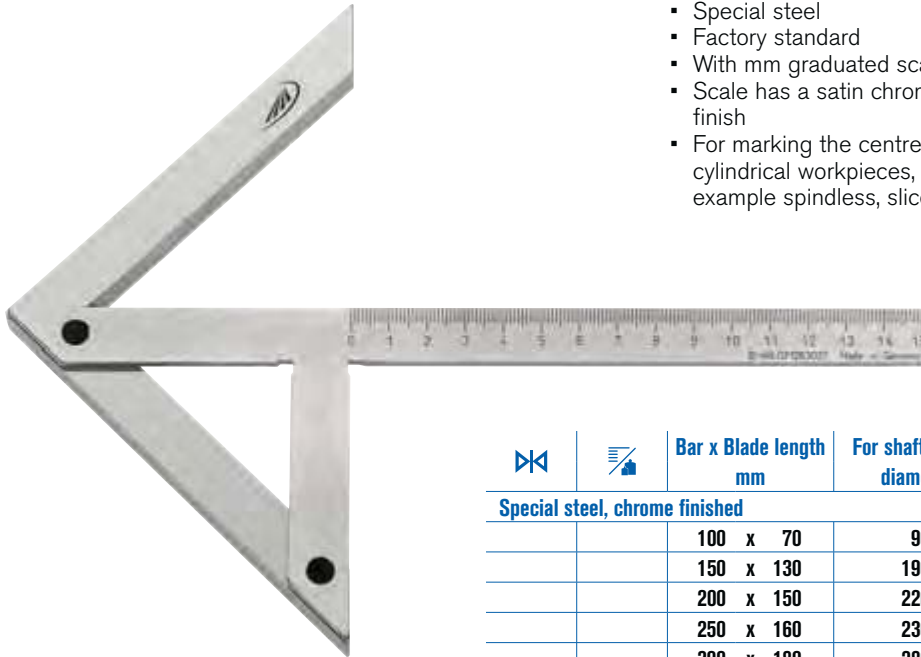

### Specification

- Special steel
- Factory standard
- With mm graduated scale
- Scale has a satin chrome finish
- For marking the centre of cylindrical workpieces, for example spindless, slices

### Shipment

- Cardboard box

		Bar x Blade length mm	For shafts up to diameter	Ref. No.	List price Euro
<b>Special steel, chrome finished</b>					
		100 x 70	90	0380 103	28.70
		150 x 130	190	0380 104	33.90
		200 x 150	220	0380 105	42.10
		250 x 160	230	0380 106	48.70
		300 x 180	280	0380 107	64.00
<b>Special steel</b>					
		400 x 250	380	0380 108	242.00
		500 x 330	530	0380 109	430.00

## 0396 Flange squares

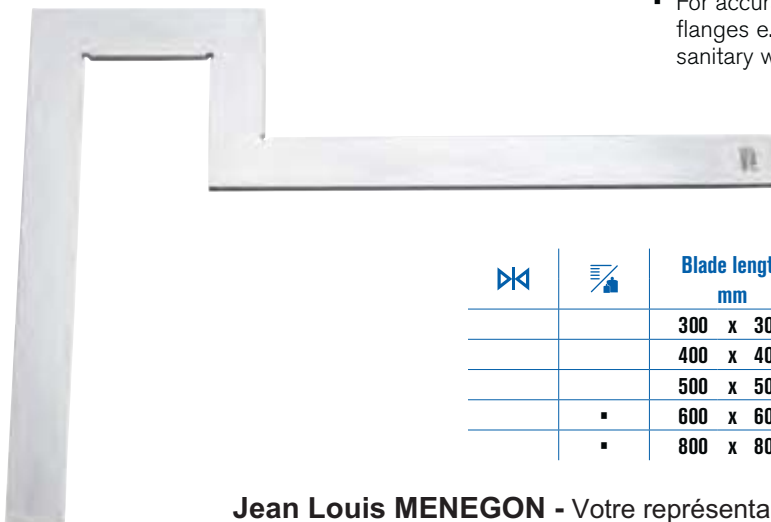

### Specification

- Special steel, zinc coated
- Factory standard
- For accurately aligning flanges e.g. in plumbing and sanitary works in pipeline

### Shipment

- Cardboard box
- From blade length 600 mm individually packed

		Blade length mm	Cross section mm	Ref. No.	List price Euro
		300 x 300	30 x 5	0396 414	14.20
		400 x 400	30 x 5	0396 416	16.90
		500 x 500	30 x 5	0396 418	20.00
	▪	600 x 600	30 x 5	0396 420	25.00
	▪	800 x 800	30 x 5	0396 426	30.00

Jean Louis MENEGON - Votre représentant et Conseiller- Tél. : 06 76 08 96 83

E-mail: [jlouismenegon@aol.com](mailto:jlouismenegon@aol.com) - web: [www.menegon-metrologie.com](http://www.menegon-metrologie.com)



0396 Carpenters squares

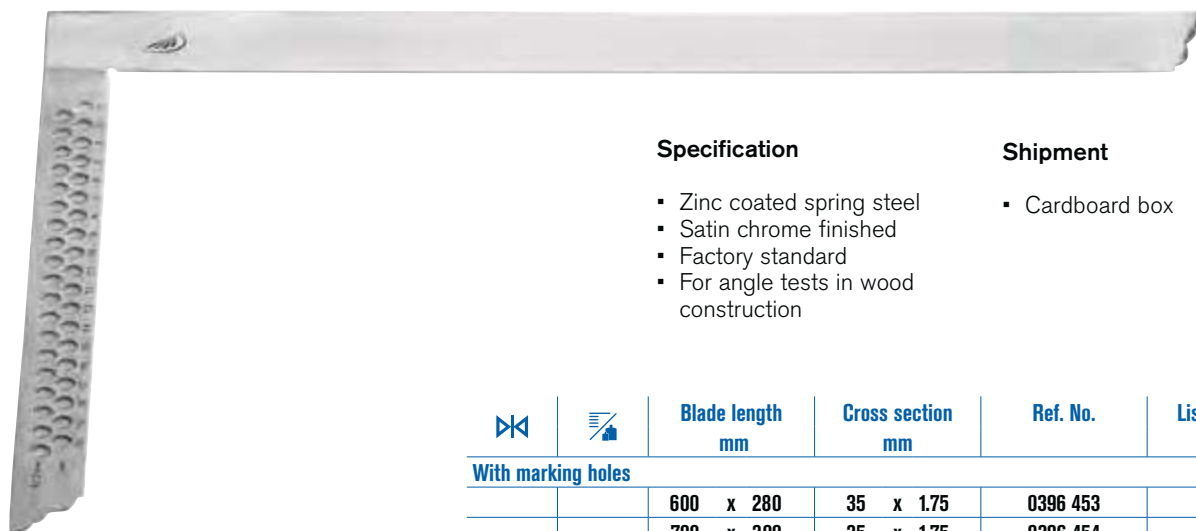

**Specification**

- Zinc coated spring steel
- Satin chrome finished
- Factory standard
- For angle tests in wood construction

**Shipment**

- Cardboard box

		Blade length mm	Cross section mm	Ref. No.	List price Euro
<b>With marking holes</b>					
		600 x 280	35 x 1.75	0396 453	12.20
		700 x 300	35 x 1.75	0396 454	13.80
		800 x 320	35 x 1.75	0396 455	15.30
		1000 x 380	35 x 1.75	0396 456	18.80
<b>Without marking holes</b>					
		600 x 280	35 x 1.75	0396 443	9.70
		700 x 300	35 x 1.75	0396 444	11.50
		800 x 320	35 x 1.75	0396 445	12.40
		1000 x 380	35 x 1.75	0396 446	16.00

Jean Louis MENEGON - Votre représentant et Conseiller- Tél. : 06 76 08 96 83

E-mail: [jlouismenegon@aol.com](mailto:jlouismenegon@aol.com) - web: [www.menegon-metrologie.com](http://www.menegon-metrologie.com)

0396 Alpha squares with marking holes



5



**Specification**

- Stainless steel
- Long blade with mm graduation, short blade used as adjustable protractor
- For marking and production of wood joints 0°-90°

**Shipment**

- Cardboard box

		Blade length mm	Cross section mm	Ref. No.	List price Euro
		430 x 795	35	0396 290	89.00



### 0396 Joiner squares with mitre

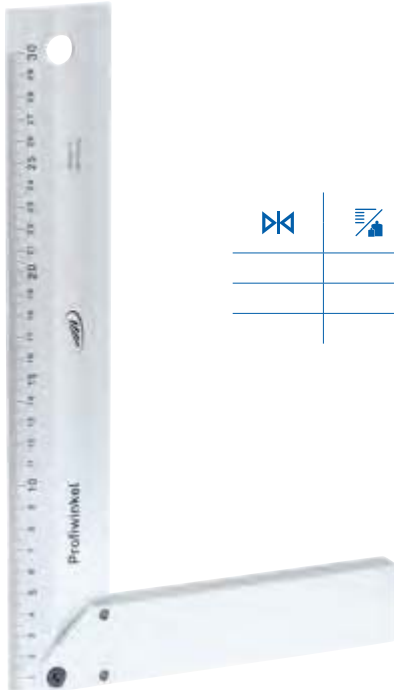

#### Specification

- Aluminium
- mm graduation

#### Shipment

- Cardboard box

		Blade length mm	Slim blade mm	Hard blade mm	Ref. No.	List price Euro
		250 x 148	50 x 5	40 x 14	0396 982	11.00
		300 x 164	50 x 5	40 x 14	0396 983	13.00
		400 x 195	50 x 5	40 x 14	0396 984	15.50

### 0396 Adjustable squares



#### Specification

- Special steel, zinc coated
- Satin chrome finished
- Screw hinge
- For transferring, marking and setting of individual angles

#### Shipment

- Cardboard box

		Blade length mm	Cross section mm	Ref. No.	List price Euro
		200	20 x 5	0396 432	9.00
		250	20 x 5	0396 433	11.20
		300	20 x 5	0396 434	13.70
		400	20 x 5	0396 435	17.50
		500	20 x 5	0396 436	19.50



Jean Louis MENEGON - Votre représentant et Conseiller- Tél. : 06 76 08 96 83

E-mail: [jlouismenegon@aol.com](mailto:jlouismenegon@aol.com) - web: [www.menegon-metrologie.com](http://www.menegon-metrologie.com)



## 0003 Wooden cases for squares



		Blade length mm	Dimensions mm	Ref. No.	List price Euro
<b>For squares with base</b>					
		50 x 40	55 x 45 x 22	0003 280	3.90
		75 x 50	80 x 55 x 22	0003 281	4.30
		100 x 70	105 x 75 x 22	0003 282	4.50
		150 x 100	160 x 105 x 27	0003 284	6.30
		200 x 130	210 x 135 x 34	0003 286	8.30
		250 x 165	260 x 170 x 38	0003 288	17.80
		300 x 200	312 x 205 x 42	0003 290	17.80
		400 x 265	412 x 270 x 48	0003 292	34.00
		500 x 330	512 x 335 x 54	0003 294	38.30
<b>For flat type squares</b>					
		50 x 40	55 x 45 x 22	0003 280	3.90
		75 x 50	80 x 55 x 22	0003 281	4.30
		100 x 70	105 x 75 x 22	0003 282	4.50
		150 x 100	160 x 105 x 22	0003 283	5.70
		200 x 130	210 x 135 x 27	0003 285	7.10
		250 x 165	260 x 170 x 27	0003 287	7.90
		300 x 200	312 x 205 x 27	0003 289	10.70
		400 x 265	412 x 270 x 27	0003 291	30.80
		500 x 330	512 x 335 x 27	0003 293	34.30



Jean Louis MENEGON - Votre représentant et Conseiller- Tél. : 06 76 08 96 83

E-mail: [jlouismenegon@aol.com](mailto:jlouismenegon@aol.com) - web: [www.menegon-metrologie.com](http://www.menegon-metrologie.com)

## 0410 Protractors



### Specification

- With rivetted hinge
- Special steel, satin chrome finished
- Factory standard
- 0 - 180°

### Shipment

- Cardboard box

✂	📏	Graduated arc dia. mm	Pointer arm mm	Ref. No.	List price Euro
		80	120	0410 301	23.00
		120	150	0410 302	29.00
		150	200	0410 303	33.00
		200	300	0410 304	49.00

## 0411 Protractors



### Specification

- Locking screw
- High precision, laser graduated degree scale
- Factory standard
- 0 - 180°

### Shipment

- Cardboard box

✂	📏	Graduated arc dia. mm	Pointer arm mm	Ref. No.	List price Euro
<b>Special steel</b>					
		80	120	0411 101	20.90
		120	150	0411 102	26.10
		150	200	0411 103	32.70
		200	300	0411 104	43.30
		300	500	0411 105	65.00
		300	600	0411 106	76.00
		300	800	0411 107	100.00
		400	600	0411 108	129.00
		400	800	0411 109	137.00
		400	1000	0411 110	142.00
<b>Special steel, satin chrome finished graduated arc</b>					
		80	120	0411 301	23.20
		120	150	0411 302	29.80
		150	200	0411 303	33.20
		200	300	0411 304	47.60
		300	500	0411 305	95.00
		300	600	0411 306	120.00
		300	800	0411 307	130.00
		400	600	0411 308	136.00
		400	800	0411 309	143.00
		400	1000	0411 310	176.00



## 0412 Protractors



### Specification

- Locking screw
- Stainless steel
- Factory standard
- 0 - 180°
- High precision, laser graduated degree scale

### Shipment

- Cardboard box

		Graduated arc dia. mm	Pointer arm mm	Ref. No.	List price Euro
		80	120	0412 201	32.70
		120	150	0412 202	35.40
		150	200	0412 203	36.40
		200	300	0412 204	51.00

## 0413 Protractors



0413 301

### Specification

- Locking screw
- Special steel
- Factory standard
- 0 - 180°
- High precision, laser graduated degree scale
- Graduated in opposite directions
- Satin chrome finished

### Shipment

- Cardboard box



0413 302

**Jean Louis MENEGON** - Votre représentant et Conseiller- Tél. : **06 76 08 96 83**  
 E-mail: [jlouismenegon@aol.com](mailto:jlouismenegon@aol.com) - web: [www.menegon-metrologie.com](http://www.menegon-metrologie.com)

		Dimensions mm	Pointer arm mm	Ref. No.	List price Euro
<b>Semicircular head</b>					
		Ø 85	150	0413 301	22.00
<b>Rectangular head</b>					
		85 x 50	150	0413 302	15.40





## 0415 Bevel protractors



### Specification

- Locking screw
- Special steel, pointer arm is satin chrome finished
- Factory standard
- Adjustable stop bar 10° - 170°
- High precision, laser graduated degree scale

### Shipment

- Cardboard box



⌘	⚙	Graduated arc dia. mm	Pointer arm mm	Ref. No.	List price Euro
		100	150	0415 301	60.00
		150	300	0415 302	93.00
		200	400	0415 303	126.00
		250	500	0415 304	173.00
		300	600	0415 305	196.00

## 0416 Bevel protractors with double stop rail



### Specification

- Locking screw
- Special steel, pointer arm is satin chrome finished
- Factory standard
- Adjustable stop bar 10° - 170°
- High precision, laser graduated degree scale
- Two-way adjustable stop bar

### Shipment

- Cardboard box



⌘	⚙	Graduated arc dia. mm	Pointer arm mm	Ref. No.	List price Euro
		100	150	0416 301	120.00
		150	300	0416 302	157.00
		200	400	0416 303	203.00
		250	500	0416 304	336.00
		300	600	0416 305	390.00

Jean Louis MENEGON - Votre représentant et Conseiller- Tél. : 06 76 08 96 83

E-mail: [jlouismenegon@aol.com](mailto:jlouismenegon@aol.com) - web: [www.menegon-metrologie.com](http://www.menegon-metrologie.com)



0422 Universal bevel protractors with magnifying lense



Specification

- Locking screw
- Stainless steel
- Factory standard
- Fine adjustment screw
- Parallax-free reading
- Reading parts are satin chrome finished
- Vernier scale reading 5 minutes
- Hardened beam

Shipment

- Wooden case

		Segment	Blade mm	Ref. No.	List price Euro
		4 x 90°	150	0422 501	125.00
		4 x 90°	200	0422 502	135.00
		4 x 90°	300	0422 503	140.00
		4 x 90°	500	0422 504	145.00

0425 DIGI-MET® Universal bevel protractors



Specification

- Clamping unit
- Stainless steel
- Factory standard

Electronic functions

- ON/OFF switch
- Zero setting at any position
- Reversible measuring range:
  - 1 x 360°
  - 2 x 180°
  - 4 x 90°
- Reversible indication
  - degree and minutes
  - decimal degree
- Data output: Opto RS 232

Shipment

- Wooden case



		Blade mm	Reading	Ref. No.	List price Euro
		150	0.01° or 1'	0425 701	985.00
		200	0.01° or 1'	0425 702	990.00
		300	0.01° or 1'	0425 703	995.00

Accessories

	Ref. No.	List price Euro
Battery, 3V-Lithium, CR 2032	0220 704	3.60
Cable for Opto to RS 232	0996 701	71.00
Cable for Opto to USB	0996 705	136.00

Jean Louis MENEGON - Votre représentant et Conseiller- Tél. : 06 76 08 96 83

E-mail: [jlouismenegon@aol.com](mailto:jlouismenegon@aol.com) - web: [www.menegon-metrologie.com](http://www.menegon-metrologie.com)



## Replacement blades for 0422 / 0425



		Blade mm	Ref. No.	List price Euro
		150	0425 211	26.50
		200	0425 212	29.80
		300	0425 213	33.40
		500	0425 214	47.10

## 0420 Universal bevel protractors



### Specification

- Locking screw
- Stainless steel
- Factory standard
- Vernier scale reading 5 minutes'

### Shipment

- Cardboard box

		Segment	Blade mm	Ref. No.	List price Euro
		4 x 90°	150	0420 201	52.00
		4 x 90°	200	0420 202	56.00
		4 x 90°	300	0420 203	60.00

Jean Louis MENEGON - Votre représentant et Conseiller- Tél. : 06 76 08 96 83

E-mail: [jlouismenegon@aol.com](mailto:jlouismenegon@aol.com) - web: [www.menegon-metrologie.com](http://www.menegon-metrologie.com)



0420 121



0420 124



0420 206



0420 122

Accessories	Ref. No.	List price Euro
Magnifying lense	0420 121	15.00
Angle stop	0420 122	58.00
Prismatic base	0420 124	67.00
Replacement blade 150 mm	0420 206	17.00
Replacement blade 200 mm	0420 207	17.80
Replacement blade 300 mm	0420 208	18.00



0417 Protractor "Pernumeter"



Specification

- Made from plastic
- Vernier reading
- mm and 3 1/2" graduation
- Locking screw

Shipment

- Case

		Segment	Reading	Dia. of index circle mm	Length of bases mm	Ref. No.	List price Euro
		2 x 90° / 2 x 0-150%	1/4°	85	100 x 100	0417 608	115.00



[www.menegon-metrologie.com](http://www.menegon-metrologie.com)

## **SERVICE IS A MATTER OF COURSE FOR US**

Working hand-in-hand is essential for us, not only because it is almost a pre-condition for portable measuring devices, but because customer focus has always been our top priority. This begins with demand-oriented production, ranging over the wide and extensive programme, right through to our own calibration laboratory. Whether repairs, advice, high availability or online presence - we want our customers to be completely happy with all that we offer.

This works so well because we focus on what we do best. And if more is required of us, we try to make it possible. Because exceptions like this show what is the rule at HELIOS-PREISSER: first-class quality in our products as well as in our service.



**Jean Louis MENEGON** - Votre représentant et Conseiller- Tél. : 06 76 08 96 83  
E-mail: [jlouismenegon@aol.com](mailto:jlouismenegon@aol.com) - web: [www.menegon-metrologie.com](http://www.menegon-metrologie.com)

## 6. CHAPTER GAUGES, RULES, INSPECTION EQUIPMENT

214	Graduated rules
218	Rules
221	Knife edge rules
222	Mounting straight edges
223	Inspection plates made from cast iron
224	Lapping and inspection plate
225	Measuring and inspection plates made from granite
226	Angle normal
227	Sinus rules, prisms
231	Sets of parallel blocks
232	Levels
234	Profile gauges, ISO indicators
237	Twist drill grinding and inspection gauges
238	Grinding / Welding gauges
239	Radius / Chamfer gauge
240	Tapered hole gauges
241	Hole gauges
242	Radius gauges
243	Feeler gauges
244	Comparative surface roughness standards
245	Feeler gauge tapes and precision reference sheets
248	Gauge blocks and accessories
258	Pin gauges
260	Plug gauges
262	Snap gauges
264	Setting rings
265	Thread plug gauges
266	Thread ring gauges



Jean Louis MENEGON - Votre représentant et Conseiller- Tél. : 06 76 08 96 83

E-mail: [jlouismenegon@aol.com](mailto:jlouismenegon@aol.com) - web: [www.menegon-metrologie.com](http://www.menegon-metrologie.com)

## 0460 Flexible steel rules

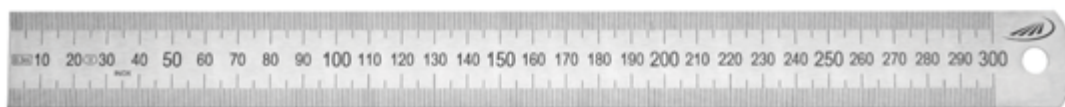

0460 204



0460 222



0460 242

## Specification

- Stainless spring band steel
- EC grade II
- Rules with special graduations or other scales are available upon request

		Length mm	Cross section mm	Ref. No.	List price Euro
<b>Scales: mm top and bottom</b>					
		150	13 x 0.5	0460 201	1.00
		200	13 x 0.5	0460 202	1.00
		300	15 x 0.5	0460 204	1.40
		500	20 x 0.5	0460 205	3.90
		1000	20 x 0.5	0460 206	8.50
		300	30 x 1.0	0460 207	3.00
		500	30 x 1.0	0460 208	7.10
		1000	30 x 1.0	0460 209	14.80
		1500	30 x 1.0	0460 210	23.90
		2000	30 x 1.0	0460 211	28.70
		3000	30 x 1.0	0460 212	66.00
	▪	3000	30 x 2.0	0460 213	103.00
<b>Scales: 1/2 mm top, mm bottom</b>					
		150	13 x 0.5	0460 221	1.00
		200	13 x 0.5	0460 222	1.00
		250	15 x 0.5	0460 223	1.40
		300	15 x 0.5	0460 224	1.40
		500	20 x 0.5	0460 225	3.90
		1000	20 x 0.5	0460 226	8.50
		300	30 x 1.0	0460 227	3.00
		500	30 x 1.0	0460 228	7.10
		1000	30 x 1.0	0460 229	14.80
		1500	30 x 1.0	0460 230	23.90
		2000	30 x 1.0	0460 231	28.70
		3000	30 x 1.0	0460 232	66.00
	▪	3000	30 x 2.0	0460 233	103.00
<b>Scales: 1/16" . 1/32" . 1/64" top; 1/2 mm. 1/1 mm bottom</b>					
		150	13 x 0.5	0460 241	1.00
		200	13 x 0.5	0460 242	1.00
		250	15 x 0.5	0460 243	1.40
		300	15 x 0.5	0460 244	1.40
		500	20 x 0.5	0460 245	3.90
		1000	20 x 0.5	0460 246	8.50
		300	30 x 1.0	0460 247	3.00
		500	30 x 1.0	0460 248	7.10
		1000	30 x 1.0	0460 249	14.80
		1500	30 x 1.0	0460 250	23.90
		2000	30 x 1.0	0460 251	28.70
		3000	30 x 1.0	0460 252	66.00
	▪	3000	30 x 2.0	0460 253	103.00



# HELIOS • PREISSER

## 0460 Flexible steel rules, satin chrome



0460 502



0460 522

### Specification

- Stainless spring band steel
- Scales satin chrome finished
- EC grade II

		Length mm	Cross section mm	Ref. No.	List price Euro
<b>Scales: mm top and bottom</b>					
		150	13 x 0.5	0460 501	2.50
		200	13 x 0.5	0460 502	3.90
		300	15 x 0.5	0460 504	4.50
		500	20 x 0.5	0460 505	9.90
		1000	20 x 0.5	0460 506	20.10
		300	30 x 1.0	0460 507	5.20
		500	30 x 1.0	0460 508	10.90
		1000	30 x 1.0	0460 509	22.70
	▪	1500	35 x 1.3	0460 510	66.00
	▪	2000	35 x 1.3	0460 511	104.00
	▪	3000	35 x 1.3	0460 512	218.00
<b>Scales: 1/2 mm top and mm bottom</b>					
		150	13 x 0.5	0460 521	2.50
		200	13 x 0.5	0460 522	3.90
		300	15 x 0.5	0460 524	4.50
		500	20 x 0.5	0460 525	9.90
		1000	20 x 0.5	0460 526	20.10
		300	30 x 1.0	0460 527	5.20
		500	30 x 1.0	0460 528	10.90
		1000	30 x 1.0	0460 529	22.70

## 0453 Aluminium straight edges, anodized



### Specification

- Bevelled edge
- Non-glare mm graduation
- Factory standard

		Length mm	Cross section mm	Ref. No.	List price Euro
		300	50 x 5	0453 422	8.20
		600	50 x 5	0453 430	12.20
		1000	50 x 5	0453 434	18.00

Jean Louis MENEGON - Votre représentant et Conseiller- Tél. : 06 76 08 96 83

E-mail: [jlouismenegon@aol.com](mailto:jlouismenegon@aol.com) - web: [www.menegon-metrologie.com](http://www.menegon-metrologie.com)





## 0458 Steel scale tapes for circumference and diameter



from 0458 104



0458 102, 0458 103

## Specification

- Factory standard
- Vernier 0.1 mm
- Main scale graduation 1 mm

## Shipment

- Cardboard box

		For circumference mm	For diameter mm	Ref. No.	List price Euro
<b>Spring band steel</b>					
		60 - 950	20 - 300	0458 102	35.40
		940 - 2200	300 - 700	0458 103	42.30
		2190 - 3460	700 - 1100	0458 104	55.00
		3450 - 4720	1100 - 1500	0458 105	65.00
		4710 - 5980	1500 - 1900	0458 106	79.00
		5960 - 7230	1900 - 2300	0458 107	90.00
		7220 - 8500	2300 - 2700	0458 108	223.00
		8480 - 9760	2700 - 3100	0458 109	240.00
		9730 - 11010	3100 - 3500	0458 110	278.00
		11000 - 12260	3500 - 3900	0458 111	433.00
		12250 - 13500	3900 - 4300	0458 112	446.00
		13500 - 14760	4300 - 4700	0458 113	450.00
		14760 - 16020	4700 - 5100	0458 114	456.00
		16020 - 17270	5100 - 5500	0458 115	467.00
		17270 - 18520	5500 - 5900	0458 116	478.00
		18350 - 19780	5900 - 6300	0458 117	613.00
<b>Stainless spring band steel</b>					
		60 - 950	20 - 300	0458 202	63.00
		940 - 2200	300 - 700	0458 203	80.00
		2190 - 3460	700 - 1100	0458 204	97.00
		3450 - 4720	1100 - 1500	0458 205	128.00
		4710 - 5980	1500 - 1900	0458 206	155.00
		5960 - 7230	1900 - 2300	0458 207	181.00

## 0458 Interior circumference tapes



		For circumference mm	For diameter mm	Ref. No.	List price Euro
		720 - 1550	230 - 490	0458 252	265.00
		940 - 2200	300 - 700	0458 253	277.00
		2190 - 3620	700 - 1100	0458 254	296.00
		3450 - 4720	1100 - 1500	0458 255	340.00
		4710 - 5980	1500 - 1900	0458 256	370.00
		5970 - 7230	1900 - 2300	0458 257	439.00
		7220 - 8500	2300 - 2700	0458 258	510.00
<b>Expanding collet for interior circumference tapes</b>					
			For all sizes	0458 291	398.00

## Specification

- To measure the internal circumference and the mean diameter of a round, oval or a continuous polygon bore
- Main scale graduation 1 mm
- Vernier 0.1 mm
- Laser graduation
- Stainless spring band steel
- The tape is attached through an expanding collet
- Cardboard box

## Shipment

Jean Louis MENEGON - Votre représentant et Conseiller- Tél. : 06 76 08 96 83

E-mail: [jlouismenegon@aol.com](mailto:jlouismenegon@aol.com) - web: [www.menegon-metrologie.com](http://www.menegon-metrologie.com)



**0451 Graduated straight rules** acc. to DIN 866, type A



**DIN 866-A**

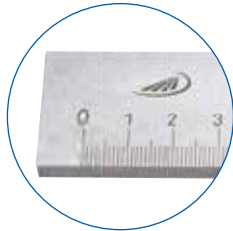

**Specification**

- 10 mm protective ends
- mm graduated scale

**Shipment**

- Cardboard box
- From 2000 mm in transportation box

		Length mm	Cross section mm	Ref. No.	List price Euro
<b>Special steel</b>					
		500	30 x 6	0451 101	23.90
		1000	40 x 8	0451 102	55.00
	▪	1500	40 x 8	0451 103	98.00
	▪	2000	50 x 10	0451 104	136.00
	▪	3000	50 x 10	0451 105	281.00
	▪	4000	60 x 12	0451 106	510.00
<b>Stainless steel</b>					
		500	30 x 6	0451 201	42.30
		1000	40 x 8	0451 202	97.00
	▪	1500	40 x 8	0451 203	144.00
	▪	2000	50 x 10	0451 204	253.00
	▪	3000	50 x 10	0451 205	510.00
	▪	4000	60 x 12	0451 206	922.00

**0452 Graduated straight rules** acc. to DIN 866, type B



**DIN 866-B**

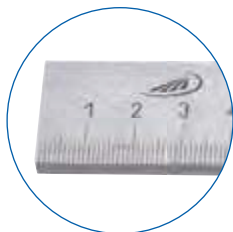

**Specification**

- Graduated scale begins directly on the end of rule, the other end has a 10 mm protective end

**Shipment**

- Cardboard box
- From 2000 mm in transportation box

		Length mm	Cross section mm	Ref. No.	List price Euro
<b>Special steel</b>					
		500	25 x 5	0452 101	16.00
		1000	30 x 6	0452 103	32.00
	▪	1500	30 x 6	0452 104	47.00
	▪	2000	40 x 8	0452 105	76.00
	▪	2500	40 x 8	0452 106	139.00
	▪	3000	40 x 8	0452 107	153.00
	▪	4000	50 x 10	0452 108	293.00
	▪	5000	60 x 12	0452 109	526.00
<b>Stainless steel</b>					
		500	25 x 5	0452 201	25.00
		1000	30 x 6	0452 203	55.00
	▪	1500	30 x 6	0452 204	93.00
	▪	2000	40 x 8	0452 205	148.00
	▪	2500	40 x 8	0452 206	283.00
	▪	3000	40 x 8	0452 207	294.00
	▪	4000	50 x 10	0452 208	528.00
	▪	5000	60 x 12	0452 209	1,007.00

6

**0455 Straight edges with bevelled edge, mm graduation****Specification**

- Special steel
- Satin chrome finished
- Factory standard
- Graduated scale begins directly on the end of rule, the other end has a 10 mm protective end

		Length mm	Cross section mm	Ref. No.	List price Euro
		400	40 x 5	0455 424	16.00
		500	40 x 5	0455 428	19.90
	▪	1000	40 x 5	0455 434	37.80
	▪	1500	40 x 5	0455 438	67.00
	▪	2000	40 x 5	0455 440	99.00
	▪	3000	50 x 8	0455 444	209.00

**Shipment**

- Cardboard box
- From 2000 mm in transportation box

**0454 Straight edges, with bevelled edge****Specification**

- Special steel
- Satin chrome finished
- Factory standard

		Length mm	Cross section mm	Ref. No.	List price Euro
		400	40 x 5	0454 424	8.70
		500	40 x 5	0454 428	10.80
	▪	1000	40 x 5	0454 434	21.50
	▪	1500	40 x 5	0454 438	39.00
	▪	2000	40 x 5	0454 440	59.00
	▪	3000	50 x 8	0454 444	156.00

**Shipment**

- Cardboard box
- From 2000 mm in transportation box





0464 – 0466 Steel rules made of special steel



DIN 874

rectangular cross section



I shaped cross section, 2 hand slots

Specification

- Special steel
- DIN 874 Sheet 1

Shipment

- Cardboard box
- From 2000 mm in transportation box

		Length mm	Cross section mm	Ref. No.	List price Euro
<b>Accuracy grade 0</b>					
<b>Special steel, rectangular cross section</b>					
		500	50 x 10	0464 101	61.00
		750	50 x 10	0464 102	87.00
		1000	60 x 12	0464 103	136.00
	▪	1500	70 x 15	0464 104	229.00
<b>Special steel, I shaped cross section, 2 hand slots</b>					
	▪	2000	80 x 15	0464 105	411.00
	▪	2500	100 x 16	0464 106	699.00
	▪	3000	120 x 18	0464 107	1,072.00
	▪	4000	140 x 20	0464 108	1,843.00
	▪	5000	140 x 20	0464 109	2,291.00
<b>Accuracy grade 1</b>					
<b>Special steel, rectangular cross section</b>					
		500	40 x 8	0465 101	29.80
		750	50 x 10	0465 102	49.40
		1000	50 x 10	0465 103	66.00
	▪	1500	60 x 12	0465 104	122.00
<b>Special steel, I shaped cross section, 2 hand slots</b>					
	▪	2000	70 x 15	0465 105	247.00
	▪	2500	80 x 15	0465 106	464.00
	▪	3000	100 x 16	0465 107	796.00
	▪	4000	120 x 18	0465 108	1,287.00
	▪	5000	140 x 20	0465 109	2,230.00
<b>Accuracy grade 2</b>					
<b>Special steel, rectangular cross section</b>					
		500	30 x 6	0466 101	20.50
		750	40 x 8	0466 102	36.00
		1000	40 x 8	0466 103	41.00
	▪	1500	50 x 10	0466 104	79.00
	▪	2000	60 x 12	0466 105	107.00
	▪	2500	70 x 15	0466 106	237.00
	▪	3000	80 x 15	0466 107	370.00
<b>Special steel, I shaped cross section, 2 hand slots</b>					
	▪	4000	100 x 16	0466 108	879.00
	▪	5000	120 x 18	0466 109	1,323.00



## 0464 – 0466 Steel rules made of stainless steel



rectangular cross section

DIN  
874

I shaped cross section, 2 hand slots

## Specification

- DIN 874 Sheet 1
- Stainless steel

		Length mm	Cross section mm	Ref. No.	List price Euro
<b>Accuracy grade 0</b>					
<b>Stainless steel, rectangular cross section</b>					
		500	50 x 10	0464 201	96.00
		750	50 x 10	0464 202	131.00
		1000	60 x 12	0464 203	247.00
	▪	1500	70 x 15	0464 204	411.00
<b>Stainless steel, I shaped cross section, 2 hand slots</b>					
	▪	2000	80 x 15	0464 205	760.00
	▪	2500	100 x 16	0464 206	1,323.00
	▪	3000	120 x 18	0464 207	2,341.00
	▪	4000	140 x 20	0464 208	4,175.00
	▪	5000	140 x 20	0464 209	5,279.00
<b>Accuracy grade 1</b>					
<b>Stainless steel, rectangular cross section</b>					
		500	40 x 8	0465 201	55.00
		750	50 x 10	0465 202	84.00
		1000	50 x 10	0465 203	151.00
	▪	1500	60 x 12	0465 204	237.00
<b>Stainless steel, I shaped cross section, 2 hand slots</b>					
	▪	2000	70 x 15	0465 205	558.00
	▪	2500	80 x 15	0465 206	850.00
	▪	3000	100 x 16	0465 207	1,637.00
	▪	4000	120 x 18	0465 208	2,411.00
	▪	5000	140 x 20	0465 209	4,421.00
<b>Accuracy grade 2</b>					
<b>Stainless steel, rectangular cross section</b>					
		500	30 x 6	0466 201	35.40
		750	40 x 8	0466 202	62.00
		1000	40 x 8	0466 203	90.00
	▪	1500	50 x 10	0466 204	189.00
	▪	2000	60 x 12	0466 205	318.00
	▪	2500	70 x 15	0466 206	528.00
	▪	3000	80 x 15	0466 207	755.00
<b>Stainless steel, I shaped cross section, 2 hand slots</b>					
	▪	4000	100 x 16	0466 208	1,405.00
	▪	5000	120 x 18	0466 209	2,106.00

Jean Louis MENEGON - Votre représentant et Conseiller- Tél. : 06 76 08 96 83

E-mail: [jlouismenegon@aol.com](mailto:jlouismenegon@aol.com) - web: [www.menegon-metrologie.com](http://www.menegon-metrologie.com)



## 0512 Knife edge rules

DIN  
874

## Specification

- DIN 874 Sheet 2, accuracy grade 00
- Thermally insulated
- Pointed tip at one end
- Special steel: glare free and burnished knife edge
- Stainless steel: non glare knife edge

## Shipment

- Imitation leather case

		Length mm	Cross section mm	Ref. No.	List price Euro
<b>Special steel, hardened and grinded</b>					
		75	25 x 5	0512 101	9.70
		100	25 x 5	0512 102	10.90
		125	25 x 5	0512 103	12.30
		150	25 x 5	0512 104	14.00
		200	29 x 7	0512 105	18.20
		300	29 x 7	0512 106	34.30
		400	33 x 10	0512 107	61.00
		500	33 x 10	0512 108	96.00
<b>Stainless steel, hardened and grinded</b>					
		75	25 x 5	0512 201	12.60
		100	25 x 5	0512 202	14.80
		125	25 x 5	0512 203	15.40
		150	25 x 5	0512 204	17.20
		200	29 x 7	0512 205	19.90
		300	29 x 7	0512 206	43.30
		400	33 x 10	0512 207	79.00
		500	33 x 10	0512 208	107.00
		600	45 x 10	0512 209	207.00
		750	60 x 12	0512 210	420.00
		1000	60 x 12	0512 211	550.00

## 0512 Wooden cases for knife edge rules



		Length mm	Ref. No.	List price Euro
		75	0512 601	5.00
		100	0512 602	5.00
		125	0512 603	5.00
		150	0512 604	6.00
		200	0512 605	7.00
		300	0512 606	8.00
		400	0512 607	10.00
		500	0512 608	15.00
		600	0512 609	15.00
		750	0512 610	30.00
		1000	0512 611	35.00

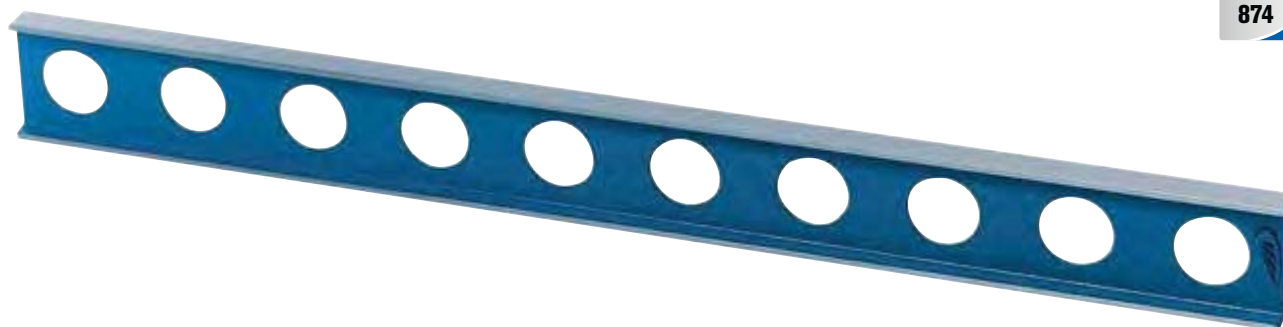

## 0467 Mounting straight edges

DIN  
874

## Specification

- DIN 874 Sheet 1
- Special steel

		Length mm	Cross section mm	Ref. No.	List price Euro
<b>Accuracy grade 0</b>					
		1000	160 x 50	0467 011	598.00
	▪	1500	160 x 50	0467 012	855.00
	▪	2000	160 x 50	0467 013	1,113.00
	▪	2500	160 x 50	0467 014	1,433.00
	▪	3000	180 x 60	0467 015	2,398.00
	▪	4000	180 x 60	0467 016	3,334.00
	▪	5000	200 x 80	0467 017	5,787.00
<b>Accuracy grade 1</b>					
		1000	100 x 30	0467 111	440.00
	▪	1500	100 x 30	0467 112	593.00
	▪	2000	120 x 40	0467 113	791.00
	▪	2500	120 x 40	0467 114	1,083.00
	▪	3000	140 x 40	0467 115	1,458.00
	▪	4000	140 x 40	0467 116	1,919.00
	▪	5000	140 x 40	0467 117	3,041.00

Jean Louis MENEGON - Votre représentant et Conseiller- Tél. : 06 76 08 96 83  
E-mail: [jlouismenegon@aol.com](mailto:jlouismenegon@aol.com) - web: [www.menegon-metrologie.com](http://www.menegon-metrologie.com)





0478 Inspection plates



DIN  
876-2



Specification

- Special cast iron
- Flatness in accordance to DIN 876-2
- Rigid ripped construction

		Dimensions mm	Ref. No.	List price Euro
<b>Accuracy grade 0, scraped</b>				
		200 x 200	0478 012	159.00
		300 x 300	0478 015	278.00
	▪	400 x 300	0478 016	350.00
	▪	400 x 400	0478 017	453.00
	▪	500 x 400	0478 018	556.00
	▪	500 x 500	0478 019	689.00
	▪	600 x 500	0478 021	864.00
	▪	800 x 500	0478 024	1,235.00
	▪	1000 x 600	0478 027	1,935.00
<b>Accuracy grade 1, finely grinded</b>				
		200 x 200	0478 112	125.00
		300 x 300	0478 115	206.00
	▪	400 x 300	0478 116	278.00
	▪	400 x 400	0478 117	350.00
	▪	500 x 400	0478 118	391.00
	▪	500 x 500	0478 119	504.00
	▪	600 x 500	0478 121	556.00
	▪	800 x 500	0478 124	926.00
	▪	1000 x 600	0478 127	1,646.00



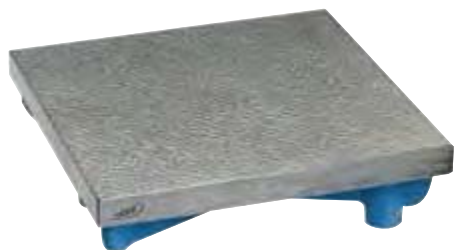

## 0478 Inspection plates

DIN  
876-2

			Dimensions mm	Ref. No.	List price Euro
<b>Accuracy grade 3, grinded</b>					
			200 x 200	0478 312	93.00
			300 x 300	0478 315	149.00
		▪	400 x 300	0478 316	180.00
		▪	400 x 400	0478 317	216.00
		▪	500 x 400	0478 318	278.00
		▪	500 x 500	0478 319	412.00
		▪	600 x 500	0478 321	453.00
		▪	800 x 500	0478 324	648.00
		▪	1000 x 600	0478 327	1,029.00

## 0478 Base stand for inspection plates



			Dimensions of inspection plates mm	Ref. No.	List price Euro
			400 x 400	0478 907	242.00
			500 x 400	0478 908	242.00
			500 x 500	0478 909	260.00
		▪	600 x 500	0478 911	272.00
		▪	800 x 500	0478 914	306.00
		▪	1000 x 600	0478 917	398.00

Jean Louis MENEGON - Votre représentant et Conseiller- Tél. : 06 76 08 96 83  
E-mail: [jlouismenegon@aol.com](mailto:jlouismenegon@aol.com) - web: [www.menegon-metrologie.com](http://www.menegon-metrologie.com)

## 0482 Lapping and inspection plate

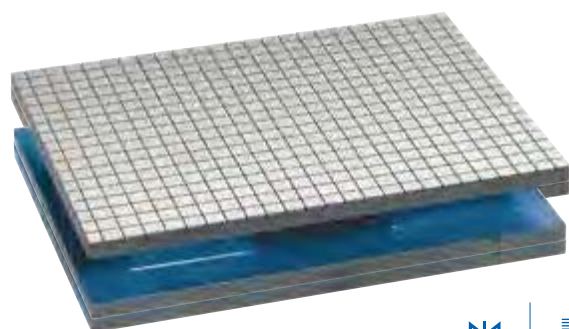

## Specification

- High grade cast iron
- Finely grinded
- One side for lapping reticular grooves,
- One side as inspection plate flat straight trough

## Shipment

- Wooden case

			Dimensions mm	Ref. No.	List price Euro
		▪	360 x 260 x 65	0482 101	450.00



## 0481 Measuring and inspection plates



**DIN  
876-1**



### Specification

- Granite
- Flatness in accordance to DIN 876-1
- Acid resistant
- Steel ball inserts

### Shipment

- Without base stand (option)

		Dimensions mm	Ref. No.	List price Euro
<b>Accuracy grade 00</b>				
	▪	400 x 400 x 50	0481 023	291.00
	▪	500 x 400 x 90	0481 024	421.00
	▪	600 x 500 x 100	0481 025	632.00
	▪	800 x 600 x 120	0481 028	1,050.00
	▪	1000 x 600 x 140	0481 030	1,199.00
	▪	1200 x 800 x 160	0481 034	1,979.00
<b>Accuracy grade 0</b>				
	▪	400 x 400 x 50	0481 043	247.00
	▪	500 x 400 x 90	0481 044	361.00
	▪	600 x 500 x 100	0481 045	536.00
	▪	800 x 600 x 120	0481 048	900.00
	▪	1000 x 600 x 140	0481 050	1,141.00
	▪	1200 x 800 x 160	0481 054	1,799.00
<b>Accuracy grade 1</b>				
	▪	400 x 400 x 50	0481 103	212.00
	▪	500 x 400 x 90	0481 104	307.00
	▪	600 x 500 x 100	0481 105	468.00
	▪	800 x 600 x 120	0481 108	780.00
	▪	1000 x 600 x 140	0481 110	1,038.00
	▪	1200 x 800 x 160	0481 114	1,651.00



## 0481 Base stand for surface and inspection plates



		Dimensions for surface plates mm	Ref. No.	List price Euro
		400 x 400	0481 160	326.00
		500 x 400	0481 161	338.00
	▪	600 x 500	0481 162	356.00
	▪	800 x 600	0481 165	380.00
	▪	1000 x 600	0481 167	398.00
	▪	1200 x 800	0481 170	452.00

## 0481 Cabinet for measuring and inspection plates



## Specification

- Frame is made of angled steel and is completely panelled with steel
- Adjustable 3 point bearing fitting
- 2 adjustable screws for stability
- Lockable doors
- Drawers on roller bearings
- Shelves are removable
- Feet are adjustable to compensate for unevenness of the floor

		Specification	For plate sizes mm	Ref. No.	List price Euro
	▪	1 door, 1 shelf	600 x 500	0481 184	1,057.00
	▪	1 door, 1 shelf	800 x 600	0481 186	1,164.00
	▪	2 doors, 1 drawer, 1 shelf	1000 x 600	0481 188	1,208.00
	▪	2 doors, 1 drawer, 1 shelf	1200 x 800	0481 190	1,350.00

## 0544 Angle normal 90°, triangular



## Specification

- Made of black granite
- From 600 x 400 mm with weight reducing holes

		Height mm	Width mm	Angle accuracy mm	Ref. No.	List price Euro
		200 x 150	40	0.002	0544 101	320.00
		300 x 200	50	0.002	0544 102	493.00
		400 x 250	60	0.003	0544 103	682.00
		500 x 300	60	0.003	0544 104	862.00
	▪	600 x 400	70	0.004	0544 105	1,467.00
	▪	800 x 500	90	0.004	0544 106	2,210.00
	▪	1000 x 600	100	0.004	0544 107	4,217.00

Jean Louis MENEGON - Votre représentant et Conseiller- Tél. : 06 76 08 96 83

E-mail: [jlouismenegon@aol.com](mailto:jlouismenegon@aol.com) - web: [www.menegon-metrologie.com](http://www.menegon-metrologie.com)



0513 Sinus rules



0513 001

DIN 2273



0513 011

Specification

- Special steel, hardened
- DIN 2273

Shipment

- With sinus table
- Cardboard box

		Roller spacing mm	Length tolerance µm	Ref. No.	List price Euro
<b>Without stop type B</b>					
		100	2	0513 001	139.00
		200	4	0513 002	159.00
<b>With stop type A</b>					
		100	2	0513 011	149.00
		200	4	0513 012	175.00

0504 V-blocks (pair)



Specification

- Special cast iron, hardened
- 90° grooves
- Machined in pairs

Shipment

- Packed in pairs
- Cardboard box

		Dimensions mm	For shafts dia. mm	Ref. No.	List price Euro
<b>Grade 0, parallelism tolerance &lt; 0.008 mm, V-grooves and base finely grinded</b>					
		100 x 40 x 30	6 - 40	0504 012	86.00
		150 x 50 x 40	8 - 50	0504 013	134.00
		200 x 70 x 50	8 - 70	0504 014	206.00
<b>Grade 1, parallelism tolerance &lt; 0.016 mm, V-grooves and base grinded</b>					
		100 x 40 x 30	6 - 40	0504 112	61.00
		150 x 50 x 40	8 - 50	0504 113	81.00
		200 x 70 x 50	8 - 70	0504 114	134.00
<b>Grade 3, parallelism tolerance &lt; 0.064 mm, V-grooves and base milled</b>					
		100 x 40 x 30	6 - 40	0504 312	42.10
		150 x 50 x 40	8 - 50	0504 313	62.00
		200 x 70 x 50	8 - 70	0504 314	102.00



## 0520 V-blocks (pair)



## Specification

- Special steel, hardened
- Flatness, parallelism and right-angled tolerance is 0.004 mm
- 90° grooves, machined in pairs
- End face and base are angular

		Dimensions mm	For shafts dia. mm	Ref. No.	List price Euro
		75 x 35 x 30	5 - 40	0520 101	123.00
		100 x 47 x 40	5 - 55	0520 102	162.00
		150 x 55 x 45	5 - 60	0520 103	215.00
		200 x 65 x 55	5 - 75	0520 104	299.00
		250 x 85 x 70	5 - 100	0520 105	409.00

## Shipment

- Packed in pairs
- Cardboard box

## 0508 Pair of X type V-blocks (parallel)



## Specification

- Factory standard
- Special cast iron
- 4 x 90° grooves, different sizes

		Dimensions mm	For shafts dia. mm	Ref. No.	List price Euro
<b>Grade 0, parallelism tolerance &lt; 0.008 mm, V-grooves and base finely grinded</b>					
		60 x 120 x 100	8 - 90	0508 011	268.00
		75 x 150 x 130	10 - 120	0508 012	323.00
	▪	90 x 200 x 170	12 - 180	0508 013	498.00
<b>Grade 1, parallelism tolerance &lt; 0.016 mm, V-grooves and base grinded</b>					
		60 x 120 x 100	8 - 90	0508 111	225.00
		75 x 150 x 130	10 - 120	0508 112	280.00
	▪	90 x 200 x 170	12 - 180	0508 113	425.00

## Shipment

- Packed in pairs
- Cardboard box

Jean Louis MENEGON - Votre représentant et Conseiller- Tél. : 06 76 08 96 83

E-mail: [jlouismenegon@aol.com](mailto:jlouismenegon@aol.com) - web: [www.menegon-metrologie.com](http://www.menegon-metrologie.com)





# HELIOS • PREISSER

Jean Louis MENEGON - Votre représentant et Conseiller- Tél. : 06 76 08 96 83

E-mail: [jlouismenegon@aol.com](mailto:jlouismenegon@aol.com) - web: [www.menegon-metrologie.com](http://www.menegon-metrologie.com)

## 0522 Double V-blocks (pairs) with clamp



### Specification

- Special steel, hardened
- Flatness, parallelism and right-angled tolerance is 0.004 mm
- 2 x 90° grooves
- Machined in pairs
- End face and base are angular

### Shipment

- Packed in pairs
- Cardboard box

		Dimensions mm	For shafts dia. mm	Ref. No.	List price Euro
		50 x 40 x 40	5 - 30	0522 101	189.00
		75 x 55 x 55	5 - 50	0522 102	230.00
		100 x 75 x 75	7 - 70	0522 103	332.00

## Clamp for double V-blocks (pairs)



### Shipment

- Packed in pairs
- Cardboard box

		Length mm	Ref. No.	List price Euro
		50	0522 111	19.00
		75	0522 112	25.00
		100	0522 113	32.00

## 0524 Double V-blocks (pairs) with clamp lateral tilting



### Specification

- Special steel, hardened
- Flatness, parallelism and right-angled tolerance is 0.004 mm
- 2 x 90° grooves
- Machined in pairs
- End face and base are angular

### Shipment

- Packed in pairs
- Cardboard box

		Dimensions mm	For shafts dia. mm	Ref. No.	List price Euro
		60 x 58 x 40	5 - 30	0524 101	172.00
		75 x 70 x 54	5 - 50	0524 102	257.00
		100 x 96 x 75	7 - 70	0524 103	386.00



Jean Louis MENEGON - Votre représentant et Conseiller- Tél. : 06 76 08 96 83

E-mail: [jlouismenegon@aol.com](mailto:jlouismenegon@aol.com) - web: [www.menegon-metrologie.com](http://www.menegon-metrologie.com)

### 0525 Adjustable V-blocks 0-60°



#### Specification

- Special steel, hardened
- Locking device
- Nonius reading

#### Shipment

- Cardboard box

		Dimensions mm	For shafts dia. mm	Ref. No.	List price Euro
		75 x 25 x 33	28	0525 101	111.00
		102 x 30 x 46	40	0525 102	118.00
		102 x 46 x 46	40	0525 103	126.00

### 0527 Magnetic measuring and clamping prism



#### Specification

- Flatness and parallelism is 0.004 mm; right-angled tolerance is 0.01 mm
- Magnet can be switched ON/OFF
- Magnetic force 600 N

#### Shipment

- Cardboard box

		Dimensions mm	For shafts dia. mm	Ref. No.	List price Euro
<b>Special steel</b>					
		80 x 67 x 96	6 - 66	0527 101	314.00
		100 x 70 x 96	6 - 70	0527 102	435.00
<b>Special steel, hardened</b>					
		80 x 67 x 96	6 - 66	0527 107	372.00
		100 x 70 x 96	6 - 70	0527 108	519.00

### 0527 Magnetic measuring and clamping prism (pairs)

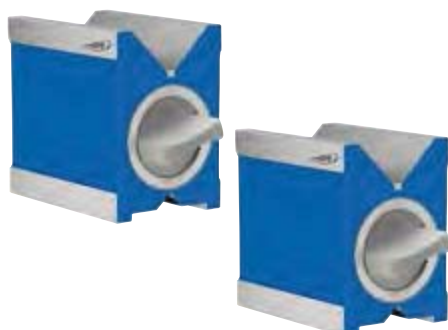

#### Specification

- Grinded in pairs

#### Shipment

- Packed in pairs
- Cardboard box

		Dimensions mm	For shafts dia. mm	Ref. No.	List price Euro
<b>Special steel</b>					
		80 x 67 x 96	6 - 66	0527 104	617.00
		100 x 70 x 96	6 - 70	0527 105	862.00
<b>Special steel, hardened</b>					
		80 x 67 x 96	6 - 66	0527 110	792.00
		100 x 70 x 96	6 - 70	0527 111	1,026.00



## 0536 Set of parallel blocks



0536 202



0536 211

### Specification

- Special steel, hardened

### Shipment

- Wooden case

		Measuring range mm	Height and parallelism tolerance mm	Height mm	Width mm	Ref. No	List price Euro
<b>Set consists of 9 pairs, length 100 mm</b>							
		10 - 42	0.01 / ±0.005	10 / 14 / 18 / 22 / 26 / 30 / 34 / 38 / 42	4	0536 220	95.00
<b>Set consists of 9 pairs, length 150 mm</b>							
		10 - 42	0.01 / ±0.005	10 / 14 / 18 / 22 / 26 30 / 34 / 38 / 42	4	0536 230	130.00
<b>Set consists of 12 pairs, length 120 mm</b>							
		14 - 40	0.01 / ±0.005	14 / 16 / 18 / 20 22 / 24 / 26 / 28 30 / 32 / 35 / 40	10	0536 201	361.00
<b>Set consists of 14 pairs, length 150 mm</b>							
		14 - 50	0.01 / ±0.005	14 / 16 / 18 / 20 22 / 24 / 26 / 28 30 / 32 / 35 / 40 45 / 50	10	0536 202	404.00
<b>Set consists of 20 pairs, length 100 mm</b>							
		2 - 24	0.01 / ±0.005	5 / 10 / 15 / 20 6 / 11 / 16 / 21 7 / 12 / 17 / 22 8 / 13 / 18 / 23 9 / 14 / 19 / 24	2 3 4 5 6	0536 211	504.00
<b>Set consists of 24 pairs, length 125 mm</b>							
		8 - 42	0.01 / ±0.005	11 / 16 / 21 / 26 / 31 / 36 13 / 18 / 23 / 28 / 33 / 38 15 / 20 / 25 / 30 / 35 / 40 17 / 22 / 27 / 32 / 37 / 42	8 10 12 14	0536 212	596.00
<b>Set consists of 24 pairs, length 150 mm</b>							
		8 - 42	0.01 / ±0.005	11 / 16 / 21 / 26 / 31 / 36 13 / 18 / 23 / 28 / 33 / 38 15 / 20 / 25 / 30 / 35 / 40 17 / 22 / 27 / 32 / 37 / 42	8 10 12 14	0536 213	601.00





## 0550 Machine levels

DIN  
877

## Specification

- DIN 877
- V-groove in the base
- Longitudinal level grinded and graduated
- Transverse level
- Thermally insulated

## Shipment

- Case

		Length mm	Ref. No.	List price Euro
<b>Reading 0.02 mm/m</b>				
		160	0550 021	230.00
		200	0550 022	250.00
		250	0550 023	265.00
		300	0550 024	315.00
<b>Reading 0.1 mm/m</b>				
		160	0550 101	165.00
		200	0550 102	170.00
		250	0550 103	180.00
		300	0550 104	205.00
<b>Reading 0.3 mm/m</b>				
		160	0550 131	125.00
		200	0550 132	150.00
		250	0550 133	160.00
		300	0550 134	185.00

## 0551 Crankpin levels

DIN  
877

## Specification

- DIN 877
- With a longitudinal and a transverse level
- Longitudinal and transverse levels grinded and graduated

## Shipment

- Case

		Length mm	Ref. No.	List price Euro
<b>Reading 0.04 mm/m</b>				
		90	0551 002	260.00
		120	0551 003	310.00
<b>Reading 0.1 mm/m</b>				
		90	0551 012	165.00
		120	0551 013	185.00
<b>Reading 0.2 mm/m</b>				
		60	0551 021	155.00

Jean Louis MENEGON - Votre représentant et Conseiller- Tél. : 06 76 08 96 83

E-mail: [jlouismenegon@aol.com](mailto:jlouismenegon@aol.com) - web: [www.menegon-metrologie.com](http://www.menegon-metrologie.com)



0556 Frame levels



DIN 877

Specification

- DIN 877
- V-grooves on 3 sides
- Longitudinal level grinded and graduated
- Transverse level
- Thermally insulated

Shipment

- Case

		Dimensions mm	Ref. No.	List price Euro
<b>Reading 0.02 mm/m</b>				
		150 x 150	0556 022	425.00
		200 x 200	0556 023	480.00
		300 x 300	0556 024	690.00
<b>Reading 0.1 mm/m</b>				
		100 x 100	0556 101	265.00
		150 x 150	0556 102	310.00
		200 x 200	0556 103	380.00
		300 x 300	0556 104	615.00
<b>Reading 0.3 mm/m</b>				
		100 x 100	0556 131	215.00
		150 x 150	0556 132	265.00
		200 x 200	0556 133	415.00
		300 x 300	0556 134	495.00

0560 Protractor level



Specification

- Made of special steel
- With degree scale
- Flat base
- 1° to 0-90°
- Ideal for levelling, determining centre points and adjusting angles

Shipment

- Wooden case

		Dimensions mm	Ref. No.	List price Euro
<b>Reading 0.4 mm/m</b>				
		200 x 200	0560 001	283.00

0563 Magnetic angle gauge



Specification

- Centre punch
- Dial face 360°
- Magnetic 90° splayed base

Shipment

- Cardboard box

		Ref. No.	List price Euro
		0563 001	385.00



Jean Louis MENEGON - Votre représentant et Conseiller- Tél. : 06 76 08 96 83  
E-mail: [jlouismenegon@aol.com](mailto:jlouismenegon@aol.com) - web: [www.menegon-metrologie.com](http://www.menegon-metrologie.com)

### 0580 Combined lathe and thread cutting gauge



#### Specification

- Special steel
- Cuts for trapezoidal (Acme), Whitworth and metric threads
- For angles from 40-80°

		Dimensions mm	Thickness mm	Ref. No.	List price Euro
		90 x 40	2	0580 101	6.80

### 0580 Combined lathe and thread cutting gauge



#### Specification

- Special steel
- Cuts for trapezoidal (Acme), Whitworth and metric threads
- With clearance angle
- For angles from 40-80°
- For angles from 0-30°

		Dimensions mm	Thickness mm	Ref. No.	List price Euro
		90 x 40	2	0580 111	9.90

### 0580 Combined lathe and thread cutting gauge



#### Specification

- Special steel
- For square threads and trapezoidal threads, Whitworth and metric threads

		Dimensions mm	Thickness mm	Ref. No.	List price Euro
		90 x 40	2	0580 121	6.90

### 0580 Universal thread cutting gauge



#### Specification

- Special steel
- For V-threads and square threads

		Dimensions mm	Thickness mm	Ref. No.	List price Euro
		90 x 40	2	0580 151	2.90



0595 ACME Thread Gauge



Specification

- Special steel
- Cuts for trapezoidal threads

		Dimensions mm	Thickness mm	Ref. No.	List price Euro
		60 x 20	2	0595 130	2.90

0595 Angled thread cutter gauge



Specification

- Special steel
- Cuts for Whitworth or metric threads

		Dimensions mm	Thickness mm	Application	Ref. No.	List price Euro
		74 x 24	2	für Whitworth thread 55°	0595 140	2.50
		74 x 24	2	for metric thread 60°	0595 142	2.50



Jean Louis MENEGON - Votre représentant et Conseiller- Tél. : 06 76 08 96 83

E-mail: [jlouismenegon@aol.com](mailto:jlouismenegon@aol.com) - web: [www.menegon-metrologie.com](http://www.menegon-metrologie.com)

## 0581 DIN thread conversion and fit slide rules



0581 101

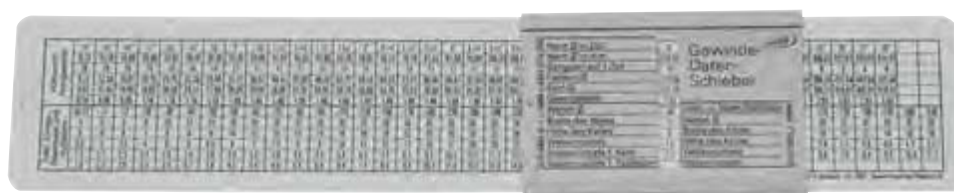

0581 123

### Specification

- For reading the most important theoretical dimensions of thread tolerance

		Ref. No.	List price Euro
Aluminium anodized	Fine thread slide rule	0581 101	19.90
	DIN thread slide rule	0581 103	13.50
	DIN fit slide rule	0581 105	18.50
Plastic	DIN thread slide rule	0581 123	9.70
	DIN fit slide rule	0581 125	8.50

## 0582 ISO thread converter - Filetor



### Specification

- For direct reading of all standard information for determining of threads
- Plastic housing

		Dimensions mm	Ref. No.	List price Euro
		60 x 30 x 110	0582 110	46.00

## 0582 ISO tolerance indicator - Tolerator



### Specification

- For direct reading of all ISO-tolerance values
- Plastic housing

		Dimensions mm	Ref. No.	List price Euro
		60 x 30 x 110	0582 120	46.00



# HELIOS • PREISSER

Jean Louis MENEGON - Votre représentant et Conseiller- Tél. : 06 76 08 96 83  
 E-mail: [jlouismenegon@aol.com](mailto:jlouismenegon@aol.com) - web: [www.menegon-metrologie.com](http://www.menegon-metrologie.com)

## 0582 mm/inch converter



### Specification

- Direct reading of inch to millimeter conversion
- Plastic housing

		Dimensions mm	Ref. No.	List price Euro
		60 x 30 x 110	0582 130	46.00

## 0589 Profile gauge



### Specification

- Spring pins
- Pin dia. 1.0 mm

		Measuring range mm	Dimensions mm	Ref. No.	List price Euro
		150 x 40	154 x 85	0589 101	15.60
		300 x 60	350 x 150	0589 103	47.60

## 0590 Twist drill grinding gauge



### Specification

- Special steel
- For twist drills
- Acute angle of 118°

		Measuring range max dia. mm	Ref. No.	List price Euro
		50	0590 101	1.60

## 0590 Twist drill grinding and inspection gauge



### Specification

- Special steel
- Measure the length of the cutting edge and the cutting angle of 118°
- Locking screw

		Measuring range mm	Vernier mm	Ref. No.	List price Euro
		50	0.1	0590 111	60.00



### 0590 Universal grinding gauge



#### Specification

- Special steel
- Scales in mm graduation
- Angles 120°, 118°, 90°, 60° and 55°

		Dimensions mm	Thickness mm	Ref. No.	List price Euro
		95 x 63	2	0590 151	3.20

### 0595 Welding gauge blank



#### Specification

- Special steel
- Pure
- For easy testing of fillet weld thicknesses of rectangular parts

		Measuring range mm	Ref. No.	List price Euro
		3 - 12	0595 110	12.20

### 0595 Welding gauge



#### Specification

- Aluminium
- Pure
- For fast reading of the weld dimensions

		Measuring range flat seams mm	Measuring range corner seams mm	Ref. No.	List price Euro
		0 - 5	2 - 15	0595 115	3.50

### 0595 DBP weld seam gauge



#### Specification

- Stainless steel
- Reading accuracy 0.1 mm
- Easy to read the result due to the reference line in the reading window
- Quick and easy inspection of welding seam heights

		Dimensions mm	Thickness mm	Ref. No.	List price Euro
		108 x 81.5	3.2	0595 251	84.00

Jean Louis MENEGON - Votre représentant et Conseiller- Tél. : 06 76 08 96 83

E-mail: [jlouismenegon@aol.com](mailto:jlouismenegon@aol.com) - web: [www.menegon-metrologie.com](http://www.menegon-metrologie.com)



0595 Welding gauge



Specification

- Special steel
- Locking screw
- Angle 60°, 70°, 80° and 90°
- To measure the height of flat welds and fillet weld thicknesses

		Dimensions mm	Thickness mm	Ref. No.	List price Euro
		20	0.1	0595 101	19.50

0597 Radius gauge



Specification

- Stainless steel
- Reading parts are satin chrome finished
- To determine radii size workpieces

Shipment

- Wooden case

		Measuring range mm	Reading mm	Ref. No.	List price Euro
		10	0.1	0597 305	162.00

0597 Chamfer gauge



Specification

- Stainless steel
- Reading 0.1 mm
- Reading parts are satin chrome finished
- For simultaneously testing of the chamfer angle and the dimensional accuracy
- Dimensions: 48x30x8.5 mm

Shipment

- Wooden case
- 3 interchangeable blades: 30°, 45°, 60°

		Dimensions mm	Thickness mm	Ref. No.	List price Euro
		10	0.1	0597 301	162.00

6





## 0598 Tapered hole gauges



0598 101

## Specification

- Special steel, hardened
- Reading parts matted

		Measuring range mm	Reading mm	Ref. No.	List price Euro
<b>Special steel</b>					
		0.5 - 11.0	0.1	0598 101	45.00
		0.5 - 7.0	0.1	0598 103	45.00
		2.0 - 7.0	0.1	0598 105	45.00
<b>Plastic</b>					
		0.5 - 11.0	0.1	0598 601	45.00

## 0599 Nozzle / small hole gauges



## Specification

- Special steel
- Reading 0.1 mm
- Cone 1:10
- Nickel finished housing

		Measuring range mm	Ref. No.	List price Euro
		0 - 3	0599 101	45.00
		0 - 5	0599 102	55.00

## 0599 Nozzle gauges



## Specification

- Steel pins
- Plastic handle
- Manufacturing tolerance  $\pm$  0.01 mm

		Measuring range mm	Pins	Ref. No.	List price Euro
		0.45 - 1.50	20	0599 151	6.50
		1.50 - 3.00	16	0599 152	6.50



# HELIOS • PREISSER

Jean Louis MENEGON - Votre représentant et Conseiller- Tél. : 06 76 08 96 83  
E-mail: [jlouismenegon@aol.com](mailto:jlouismenegon@aol.com) - web: [www.menegon-metrologie.com](http://www.menegon-metrologie.com)

## 0600 Tapered hole gauges



0600 101



0600 111

### Specification

- Reading 0.1 mm

		Measuring range mm	Ref. No.	List price Euro
<b>Special steel, flat</b>				
		1 - 15	0600 101	23.90
		15 - 30	0600 102	29.80
		30 - 45	0600 103	32.00
<b>Hardened stainless steel, round, knurled handle</b>				
		1 - 6	0600 111	51.00
		4 - 15	0600 112	67.00
		15 - 30	0600 113	141.00
		30 - 45	0600 114	218.00
		45 - 60	0600 115	351.00

## 0601 Drill and steel wire hole gauges (millimeter)



### Specification

- Special steel, nitrided
- Additional specifications are available upon request

		Measuring range mm	Increments mm	Ref. No.	List price Euro
		0.1 - 10.0	0.1	0601 103	84.00
		3.0 - 10.0	0.1	0601 120	64.00

## 0604 Radius gauges



### Specification

- Concave and convex
- Locking nut
- Milled finish

		Measuring range mm	No. of sheets mm	Ref. No.	List price Euro
<b>Special steel</b>					
		1.0 - 7.0	17	0604 002	6.30
		7.5 - 15.0	16	0604 004	6.90
		15.5 - 25.0	15	0604 006	6.90
<b>Stainless steel</b>					
		1.0 - 7.0	17	0604 202	8.30
		7.5 - 15.0	16	0604 204	10.30
		15.5 - 25.0	15	0604 206	10.30



Jean Louis MENEGON - Votre représentant et Conseiller- Tél. : 06 76 08 96 83

E-mail: [jlouismenegon@aol.com](mailto:jlouismenegon@aol.com) - web: [www.menegon-metrologie.com](http://www.menegon-metrologie.com)

## 0604 Precision individual radius gauges



### Specification

- Special steel
- Factory standard
- Fine grinded
- For internal and external radii
- Custom sizes are available upon request

		Radius mm	Ref. No.	List price Euro
		0.5	0604 013	49.00
		0.6	0604 014	49.00
		0.7	0604 015	49.00
		0.8	0604 016	49.00
		0.9	0604 017	49.00
		1.0	0604 018	49.00
		1.5	0604 019	49.00
		2.0	0604 020	49.00
		2.5	0604 021	49.00
		3.0	0604 022	49.00
		3.5	0604 023	49.00
		4.0	0604 024	49.00
		4.5	0604 025	31.80
		5.0	0604 026	31.80
		5.5	0604 027	31.80
		6.0	0604 028	31.80
		6.5	0604 029	31.80
		7.0	0604 030	31.80
		7.5	0604 031	31.80
		8.0	0604 032	31.80
		8.5	0604 033	31.80
		9.0	0604 034	31.80
		9.5	0604 035	31.80
		10.0	0604 036	31.80
		10.5	0604 037	33.40
		11.0	0604 038	33.40
		11.5	0604 039	33.40
		12.0	0604 040	33.40
		12.5	0604 041	33.40
		13.0	0604 042	33.40
		13.5	0604 043	33.40
		14.0	0604 044	33.40
		14.5	0604 045	33.40
		15.0	0604 046	33.40
		15.5	0604 047	35.20
		16.0	0604 048	35.20
		16.5	0604 049	35.20

		Radius mm	Ref. No.	List price Euro
		17.0	0604 050	35.20
		17.5	0604 051	35.20
		18.0	0604 052	35.20
		18.5	0604 053	35.20
		19.0	0604 054	35.20
		19.5	0604 055	35.20
		20.0	0604 056	35.20
		21.0	0604 057	36.70
		22.0	0604 058	36.70
		23.0	0604 059	36.70
		24.0	0604 060	36.70
		25.0	0604 061	36.70
		26.0	0604 062	36.70
		27.0	0604 063	36.70
		28.0	0604 064	36.70
		29.0	0604 065	36.70
		30.0	0604 066	36.70
		31.0	0604 067	40.00
		32.0	0604 068	40.00
		33.0	0604 069	40.00
		34.0	0604 070	40.00
		35.0	0604 071	40.00
		36.0	0604 072	40.00
		37.0	0604 073	40.00
		38.0	0604 074	40.00
		39.0	0604 075	40.00
		40.0	0604 076	40.00
		41.0	0604 077	48.50
		42.0	0604 078	48.50
		43.0	0604 079	48.50
		44.0	0604 080	48.50
		45.0	0604 081	48.50
		46.0	0604 082	48.50
		47.0	0604 083	48.50
		48.0	0604 084	48.50
		49.0	0604 085	48.50
		50.0	0604 086	48.50
		55.0	0604 087	52.00
		60.0	0604 088	55.00
		65.0	0604 089	58.00
		70.0	0604 090	66.00
		75.0	0604 091	66.00
		80.0	0604 092	66.00
		85.0	0604 093	66.00
		90.0	0604 094	66.00
		95.0	0604 095	66.00
		100.0	0604 096	66.00





0605 Screw pitch gauges



Jean Louis MENEGON - Votre représentant et Conseiller- Tél. : 06 76 08 96 83  
E-mail: [jlouismenegon@aol.com](mailto:jlouismenegon@aol.com) - web: [www.menegon-metrologie.com](http://www.menegon-metrologie.com)

			Measuring range mm	No. of blades mm	Ref. No.	List price Euro
		Metric threads according to ISO	0.25 - 6.00	24	0605 101	2.30
		Whitworth threads according to DIN	4 - 62	28	0605 103	2.10
		Whitworth pipe threads	8 - 28	6	0605 104	2.10
		Combined metric and Whitworth	0.25 - 6.00 / 4 - 62	52	0605 106	3.40
		Metric Whitworth and pipe threads	0.25 - 6.00 / 4 - 62 / 8 - 28	58	0605 107	4.70
		Combined metric threads according to SI System	0.4 - 7.0	20	0605 102	2.10
		Combined metric SI and Whitworth threads	0.4 - 7.0 / 4 - 62	48	0605 105	3.20
		US - threads	4 - 42	30	0605 108	2.80
		US - threads SAE	10 - 40	14	0605 109	3.00
		UNC - threads	4 - 64	22	0605 110	2.80
		UNF - threads	12 - 80	16	0605 111	2.80
		BSF - threads	4 - 26	20	0605 112	3.20

0606 / 0607 Feeler gauges



0606 130

Specification

- Conical blades
- Width 10 mm
- Blade length 100 mm
- Locking nut



0607 201



0607 401

		Measuring range mm	No. of blades mm	Ref. No.	List price Euro
<b>Spring band steel</b>					
		0.03 - 0.10	8	0606 121	1.40
		0.05 - 0.50	8	0606 123	1.40
		0.05 - 1.00	13	0606 127	1.40
		0.05 - 1.00	20	0606 130	2.30
		0.05 - 2.00	21	0606 133	5.20
		0.10 - 2.00	20	0606 131	5.70
		0.10 - 0.50	21	0606 132	2.80
		0.03 - 1.00	32	0606 136	4.70
<b>Spring band stainless steel</b>					
		0.05 - 0.50	8	0607 201	3.60
		0.05 - 1.00	13	0607 202	5.70
		0.05 - 1.00	20	0607 203	8.10
<b>Brass (anti-magnetic)</b>					
		0.05 - 0.50	8	0607 401	6.10
		0.05 - 1.00	13	0607 402	7.50
		0.05 - 1.00	20	0607 403	10.70



## 0606 Feeler gauges, long version



### Specification

- Blades cylindrical
- Width 13 mm
- Combination on a ring

		Measuring range mm	Length mm	No. of blades	Ref. No.	List price Euro
		0.05 - 0.5	150	8	0606 150	3.20
		0.05 - 0.5	200	8	0606 152	3.80
		0.05 - 0.5	300	8	0606 154	5.50
		0.05 - 1.0	200	13	0606 160	8.20
		0.05 - 1.0	300	13	0606 162	9.40
		0.05 - 1.0	200	20	0606 170	9.90
		0.05 - 1.0	300	20	0606 172	12.50
		0.1 - 2.0	200	20	0606 176	16.60
		0.1 - 2.0	300	20	0606 178	24.20

## 0584 Comparative surface roughness standards



### Specification

- 6 manufacturing processes
- 30 comparative standards

### Shipment

- Plastic case

		Ref. No.	List price Euro
		0584 101	293.00

Jean Louis MENEGON - Votre représentant et Conseiller- Tél. : 06 76 08 96 83

E-mail: [jlouismenegon@aol.com](mailto:jlouismenegon@aol.com) - web: [www.menegon-metrologie.com](http://www.menegon-metrologie.com)





# HELIOS • PREISSER

Jean Louis MENEGON - Votre représentant et Conseiller- Tél. : 06 76 08 96 83

E-mail: [jlouismenegon@aol.com](mailto:jlouismenegon@aol.com) - web: [www.menegon-metrologie.com](http://www.menegon-metrologie.com)

## 0611 Feeler gauge tapes



### Specification

- Hardened carbon steel
- Width 13 mm
- Length 5 m
- Tape from 0.08 mm upwards marked with dimension

### Shipment

- Plastic dispenser case

✂	📏	Thickness mm	Ref. No.	List price Euro
		0.005	0611 300	73.00
		0.01	0611 501	28.90
		0.02	0611 502	24.00
		0.03	0611 503	8.30
		0.04	0611 504	8.30
		0.05	0611 505	6.30
		0.06	0611 506	6.50
		0.07	0611 507	6.50
		0.08	0611 508	6.50
		0.09	0611 509	6.50
		0.10	0611 510	5.60
		0.12	0611 512	5.60
		0.15	0611 515	5.60
		0.18	0611 518	7.30
		0.20	0611 520	5.60
		0.25	0611 525	5.60

✂	📏	Thickness mm	Ref. No.	List price Euro
		0.30	0611 530	5.60
		0.35	0611 535	5.60
		0.40	0611 540	6.50
		0.45	0611 545	6.50
		0.50	0611 550	6.50
		0.55	0611 552	8.30
		0.60	0611 554	8.30
		0.65	0611 556	8.30
		0.70	0611 558	8.30
		0.75	0611 560	8.30
		0.80	0611 562	8.30
		0.85	0611 564	8.50
		0.90	0611 566	8.90
		0.95	0611 568	8.90
		1.00	0611 570	8.90

## 0611 Holder for feeler gauge tapes



### Specification

- Dimension 125 x 17 mm
- Without magnet

✂	📏	Ref. No.	List price Euro
		0611 195	2.50

## 0611 Wall holder for feeler gauge tape set



### Specification

- 15 piece feeler gauge tape set, refillable with selected feeler gauges
- Wall holder made of steel, gloss coated
- With size labels

### Shipment

- Holder and mounting fittings

✂	📏	Dimensions mm	Graduation mm	Ref. No.	List price Euro
		330 x 100 x 110	0.01 - 0.25	0611 180	140.00
		330 x 210 x 220	0.30 - 1.00	0611 190	185.00



## 0613 Precision feeler gauge tapes

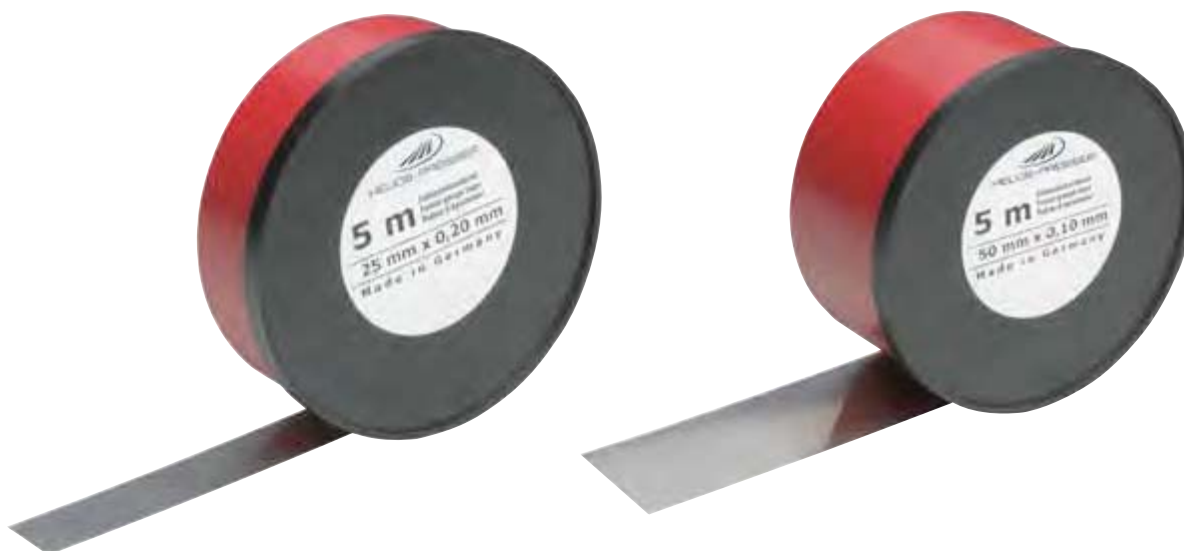

Thickness mm	Carbon steel, width 25 mm length 5 m		Carbon steel, width 50 mm length 5 m		Stainless steel, width 100 mm length 5 m		Stainless steel, width 150 mm length 5 m		Brass, width 150 mm length 5 m	
	Ref. No.	List price Euro	Ref. No.	List price Euro	Ref. No.	List price Euro	Ref. No.	List price Euro	Ref. No.	List price Euro
0.01	0613 107	63.00	0613 207	90.00						
0.02	0613 109	33.90	0613 209	48.70	0613 309	87.00				
0.025							0613 412	99.00	0613 512	98.00
0.03	0613 114	23.90	0613 214	34.30						
0.04	0613 116	23.90	0613 216	34.30						
0.05	0613 118	23.90	0613 218	34.30	0613 318	52.00	0613 418	80.00	0613 518	79.00
0.06	0613 120	16.30	0613 220	23.40						
0.07	0613 122	16.30	0613 222	23.40						
0.075							0613 424	80.00	0613 524	79.00
0.08	0613 126	16.30	0613 226	23.40						
0.09	0613 128	16.30	0613 228	23.40						
0.10	0613 130	16.80	0613 230	24.30	0613 330	49.40	0613 430	76.00	0613 530	75.00
0.12			0613 232	24.30						
0.15	0613 134	16.80	0613 234	24.30	0613 334	49.40	0613 434	76.00	0613 534	75.00
0.18			0613 236	24.30						
0.20	0613 138	16.80	0613 238	24.30	0613 338	63.00	0613 438	95.00	0613 538	93.00
0.25			0613 240	24.30			0613 440	95.00	0613 540	93.00
0.30	0613 142	16.80	0613 242	24.30	0613 342	63.00	0613 442	95.00	0613 542	93.00
0.35			0613 244	26.50						
0.40	0613 146	18.70	0613 246	26.50	0613 346	71.00	0613 446	105.00	0613 546	104.00
0.45			0613 248	26.50						
0.50	0613 150	18.70	0613 250	26.50	0613 350	81.00	0613 450	123.00	0613 550	122.00
0.60	0613 152	29.80	0613 252	43.10	0613 352	97.00				
0.70	0613 154	29.80	0613 254	43.10	0613 354	97.00				
0.80	0613 156	29.80	0613 256	43.10	0613 356	116.00				
0.90	0613 158	29.80	0613 258	43.10	0613 358	116.00				
1.00	0613 160	29.80	0613 260	43.10	0613 360	133.00				

Jean Louis MENEGON - Votre représentant et Conseiller- Tél. : 06 76 08 96 83

E-mail: [jlouismenegon@aol.com](mailto:jlouismenegon@aol.com) - web: [www.menegon-metrologie.com](http://www.menegon-metrologie.com)



0613 Precision reference sheets

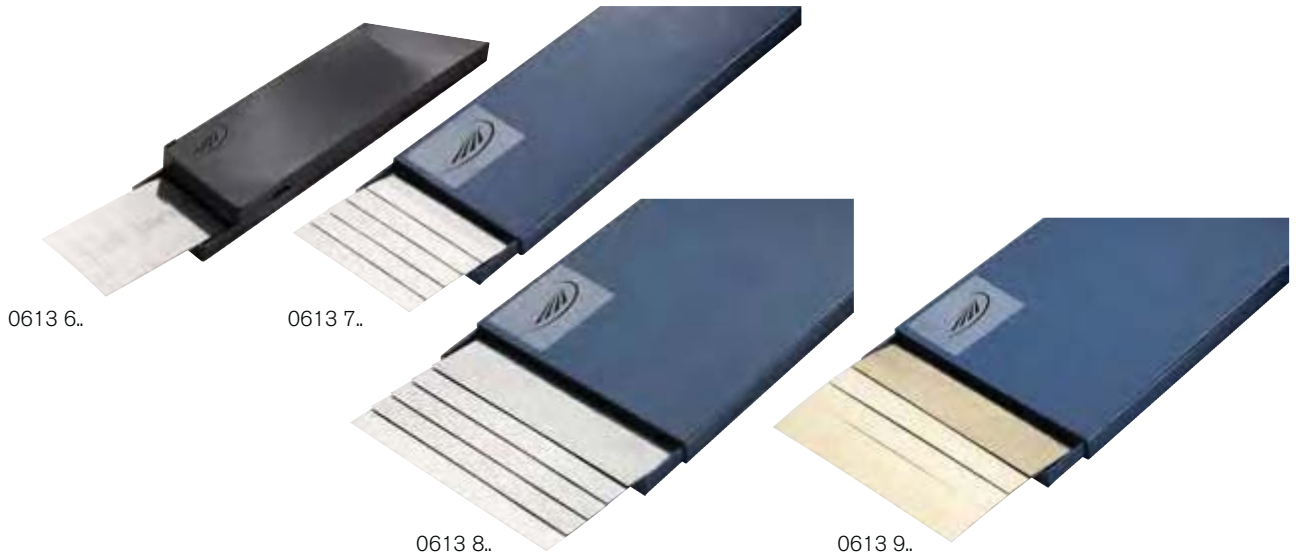

Thickness mm	Carbon steel, 50 x 300 mm 10 pieces		Stainless steel, 100 x 500 mm 5 pieces		Stainless steel, 150 x 500 mm 5 pieces		Brass, 150 x 500 mm 5 pieces	
	Ref. No.	List price Euro	Ref. No.	List price Euro	Ref. No.	List price Euro	Ref. No.	List price Euro
0.01	0613 607	63.00						
0.02	0613 609	33.90	0613 709	46.70				
0.025					0613 812	52.00	0613 912	52.00
0.03	0613 614	23.90						
0.04	0613 616	23.90						
0.05	0613 618	23.90	0613 718	28.30	0613 818	42.10	0613 918	41.60
0.06	0613 620	16.30						
0.07	0613 622	16.30						
0.075					0613 824	42.10	0613 924	41.60
0.08	0613 626	16.30						
0.09	0613 628	16.30						
0.10	0613 630	16.80	0613 730	26.50	0613 830	39.80	0613 930	39.50
0.12	0613 632	16.80						
0.15	0613 634	16.80	0613 734	26.50	0613 834	39.80	0613 934	39.50
0.18	0613 636	16.80						
0.20	0613 638	16.80	0613 738	33.40	0613 838	49.80	0613 938	49.40
0.25	0613 640	16.80			0613 840	49.80	0613 940	49.40
0.30	0613 642	16.80	0613 742	33.40	0613 842	49.80	0613 942	49.40
0.35	0613 644	18.70						
0.40	0613 646	18.70	0613 746	37.70	0613 846	58.00	0613 946	58.00
0.45	0613 648	18.70						
0.50	0613 650	18.70	0613 750	43.10	0613 850	67.00	0613 950	66.00
0.60	0613 652	29.80	0613 752	52.00				
0.70	0613 654	29.80	0613 754	52.00				
0.80	0613 656	29.80	0613 756	63.00				
0.90	0613 658	29.80	0613 758	63.00				
1.00	0613 660	29.80	0613 760	69.00	0613 860	109.00		

Jean Louis MENEGON - Votre représentant et Conseiller- Tél. : 06 76 08 96 83  
 E-mail: [jlouismenegon@aol.com](mailto:jlouismenegon@aol.com) - web: [www.menegon-metrologie.com](http://www.menegon-metrologie.com)





## 0623 - 0625 Individual steel gauge blocks



## Specification

- EN ISO 3650
- Special steel, hardened

Jean Louis MENEGON - Votre représentant et Conseiller- Tél. : 06 76 08 96 83

E-mail: [jlouismenegon@aol.com](mailto:jlouismenegon@aol.com) - web: [www.menegon-metrologie.com](http://www.menegon-metrologie.com)

Nominal size mm	Tolerance class 0		Tolerance class 1		Tolerance class 2	
	Ref. No.	List price Euro	Ref. No.	List price Euro	Ref. No.	List price Euro
0.500	0623 100	39.00	0624 100	26.00	0625 100	21.00
1.000	0623 102	33.00	0624 102	22.00	0625 102	18.00
1.001	0623 104	33.00	0624 104	22.00	0625 104	18.00
1.002	0623 106	33.00	0624 106	22.00	0625 106	18.00
1.003	0623 108	33.00	0624 108	22.00	0625 108	18.00
1.004	0623 110	33.00	0624 110	22.00	0625 110	18.00
1.005	0623 112	33.00	0624 112	22.00	0625 112	18.00
1.006	0623 114	33.00	0624 114	22.00	0625 114	18.00
1.007	0623 116	33.00	0624 116	22.00	0625 116	18.00
1.008	0623 118	33.00	0624 118	22.00	0625 118	18.00
1.009	0623 120	33.00	0624 120	22.00	0625 120	18.00
1.010	0623 122	33.00	0624 122	22.00	0625 122	18.00
1.020	0623 130	33.00	0624 130	22.00	0625 130	18.00
1.030	0623 135	33.00	0624 135	22.00	0625 135	18.00
1.040	0623 140	33.00	0624 140	22.00	0625 140	18.00
1.050	0623 145	33.00	0624 145	22.00	0625 145	18.00
1.060	0623 150	33.00	0624 150	22.00	0625 150	18.00
1.070	0623 155	33.00	0624 155	22.00	0625 155	18.00
1.080	0623 160	33.00	0624 160	22.00	0625 160	18.00
1.090	0623 165	33.00	0624 165	22.00	0625 165	18.00
1.100	0623 170	33.00	0624 170	22.00	0625 170	18.00
1.110	0623 175	33.00	0624 175	22.00	0625 175	18.00
1.120	0623 180	33.00	0624 180	22.00	0625 180	18.00
1.130	0623 185	33.00	0624 185	22.00	0625 185	18.00
1.140	0623 190	33.00	0624 190	22.00	0625 190	18.00
1.150	0623 195	33.00	0624 195	22.00	0625 195	18.00
1.160	0623 200	33.00	0624 200	22.00	0625 200	18.00
1.170	0623 205	33.00	0624 205	22.00	0625 205	18.00
1.180	0623 210	33.00	0624 210	22.00	0625 210	18.00
1.190	0623 215	33.00	0624 215	22.00	0625 215	18.00
1.200	0623 220	33.00	0624 220	22.00	0625 220	18.00
1.210	0623 225	33.00	0624 225	22.00	0625 225	18.00
1.220	0623 230	33.00	0624 230	22.00	0625 230	18.00
1.230	0623 235	33.00	0624 235	22.00	0625 235	18.00
1.240	0623 240	33.00	0624 240	22.00	0625 240	18.00
1.250	0623 245	33.00	0624 245	22.00	0625 245	18.00
1.260	0623 250	33.00	0624 250	22.00	0625 250	18.00
1.270	0623 255	33.00	0624 255	22.00	0625 255	18.00



# HELIOS • PREISSER

Jean Louis MENEGON - Votre représentant et Conseiller- Tél. : 06 76 08 96 83

E-mail: [jlouismenegon@aol.com](mailto:jlouismenegon@aol.com) - web: [www.menegon-metrologie.com](http://www.menegon-metrologie.com)

## 0623 - 0625 Individual steel gauge blocks

Nominal size mm	Tolerance class 0		Tolerance class 1		Tolerance class 2	
	Ref. No.	List price Euro	Ref. No.	List price Euro	Ref. No.	List price Euro
1.280	0623 260	33.00	0624 260	22.00	0625 260	18.00
1.290	0623 265	33.00	0624 265	22.00	0625 265	18.00
1.300	0623 270	33.00	0624 270	22.00	0625 270	18.00
1.310	0623 275	33.00	0624 275	22.00	0625 275	18.00
1.320	0623 280	33.00	0624 280	22.00	0625 280	18.00
1.330	0623 285	33.00	0624 285	22.00	0625 285	18.00
1.340	0623 290	33.00	0624 290	22.00	0625 290	18.00
1.350	0623 295	33.00	0624 295	22.00	0625 295	18.00
1.360	0623 300	33.00	0624 300	22.00	0625 300	18.00
1.370	0623 305	33.00	0624 305	22.00	0625 305	18.00
1.380	0623 310	33.00	0624 310	22.00	0625 310	18.00
1.390	0623 315	33.00	0624 315	22.00	0625 315	18.00
1.400	0623 320	33.00	0624 320	22.00	0625 320	18.00
1.410	0623 325	33.00	0624 325	22.00	0625 325	18.00
1.420	0623 330	33.00	0624 330	22.00	0625 330	18.00
1.430	0623 335	33.00	0624 335	22.00	0625 335	18.00
1.440	0623 340	33.00	0624 340	22.00	0625 340	18.00
1.450	0623 345	33.00	0624 345	22.00	0625 345	18.00
1.460	0623 350	33.00	0624 350	22.00	0625 350	18.00
1.470	0623 355	33.00	0624 355	22.00	0625 355	18.00
1.480	0623 360	33.00	0624 360	22.00	0625 360	18.00
1.490	0623 365	33.00	0624 365	22.00	0625 365	18.00
1.500	0623 370	33.00	0624 370	22.00	0625 370	18.00
1.600	0623 375	33.00	0624 375	22.00	0625 375	18.00
1.700	0623 380	33.00	0624 380	22.00	0625 380	18.00
1.800	0623 385	33.00	0624 385	22.00	0625 385	18.00
1.900	0623 390	33.00	0624 390	22.00	0625 390	18.00
2.000	0623 395	33.00	0624 395	22.00	0625 395	18.00
2.500	0623 400	35.00	0624 400	23.00	0625 400	18.00
3.000	0623 405	35.00	0624 405	23.00	0625 405	18.00
3.500	0623 410	35.00	0624 410	23.00	0625 410	18.00
4.000	0623 415	35.00	0624 415	23.00	0625 415	18.00
4.500	0623 420	35.00	0624 420	23.00	0625 420	18.00
5.000	0623 425	35.00	0624 425	23.00	0625 425	18.00
5.500	0623 430	35.00	0624 430	23.00	0625 430	18.00
6.000	0623 435	35.00	0624 435	23.00	0625 435	18.00
6.500	0623 440	35.00	0624 440	23.00	0625 440	18.00
7.000	0623 445	35.00	0624 445	23.00	0625 445	18.00
7.500	0623 450	35.00	0624 450	23.00	0625 450	18.00
8.000	0623 455	35.00	0624 455	23.00	0625 455	18.00
8.500	0623 460	35.00	0624 460	23.00	0625 460	18.00
9.000	0623 465	35.00	0624 465	23.00	0625 465	18.00
9.500	0623 470	35.00	0624 470	23.00	0625 470	18.00
10.000	0623 475	42.00	0624 475	28.00	0625 475	22.00
11.000	0623 500	42.00	0624 500	28.00	0625 500	22.00
12.000	0623 510	42.00	0624 510	28.00	0625 510	22.00
13.000	0623 520	42.00	0624 520	28.00	0625 520	22.00
14.000	0623 530	42.00	0624 530	28.00	0625 530	22.00
15.000	0623 540	42.00	0624 540	28.00	0625 540	22.00
16.000	0623 550	42.00	0624 550	28.00	0625 550	22.00
17.000	0623 560	42.00	0624 560	28.00	0625 560	22.00
18.000	0623 570	42.00	0624 570	28.00	0625 570	22.00



## 0623 - 0625 Individual steel gauge blocks



Nominal size mm	Tolerance class 0		Tolerance class 1		Tolerance class 2	
	Ref. No.	List price Euro	Ref. No.	List price Euro	Ref. No.	List price Euro
19.000	0623 580	42.00	0624 580	28.00	0625 580	22.00
20.000	0623 590	42.00	0624 590	28.00	0625 590	22.00
21.000	0623 600	42.00	0624 600	28.00	0625 600	22.00
22.000	0623 610	42.00	0624 610	28.00	0625 610	22.00
23.000	0623 620	42.00	0624 620	28.00	0625 620	22.00
24.000	0623 630	42.00	0624 630	28.00	0625 630	22.00
25.000	0623 640	42.00	0624 640	28.00	0625 640	22.00
30.000	0623 650	50.00	0624 650	33.00	0625 650	26.00
35.000	0623 660	50.00	0624 660	33.00	0625 660	26.00
40.000	0623 670	50.00	0624 670	33.00	0625 670	26.00
50.000	0623 680	50.00	0624 680	33.00	0625 680	26.00
60.000	0623 690	50.00	0624 690	33.00	0625 690	26.00
70.000	0623 700	50.00	0624 700	33.00	0625 700	26.00
80.000	0623 710	62.00	0624 710	41.00	0625 710	33.00
90.000	0623 720	62.00	0624 720	41.00	0625 720	33.00
100.000	0623 730	74.00	0624 730	49.00	0625 730	39.00
125.000	0623 740	262.00	0624 740	159.00	0625 740	127.00
150.000	0623 750	262.00	0624 750	159.00	0625 750	127.00
175.000	0623 760	262.00	0624 760	159.00	0625 760	127.00
200.000	0623 770	312.00	0624 770	189.00	0625 770	136.00
300.000	0623 780	446.00	0624 780	270.00	0625 780	215.00
400.000	0623 790	578.00	0624 790	350.00	0625 790	252.00
500.000	0623 800	800.00	0624 800	485.00	0625 800	330.00
600.000	0623 810	1,249.00	0624 810	675.00	0625 810	410.00
700.000	0623 820	1,295.00	0624 820	700.00	0625 820	490.00
800.000	0623 830	1,600.00	0624 830	865.00	0625 830	606.00
900.000	0623 840	1,896.00	0624 840	1,025.00	0625 840	718.00
1000.000	0623 850	2,350.00	0624 850	1,270.00	0625 850	889.00

Jean Louis MENEGON - Votre représentant et Conseiller- Tél. : 06 76 08 96 83

E-mail: [jlouismenegon@aol.com](mailto:jlouismenegon@aol.com) - web: [www.menegon-metrologie.com](http://www.menegon-metrologie.com)





## 0633 Parallel steel gauge block sets

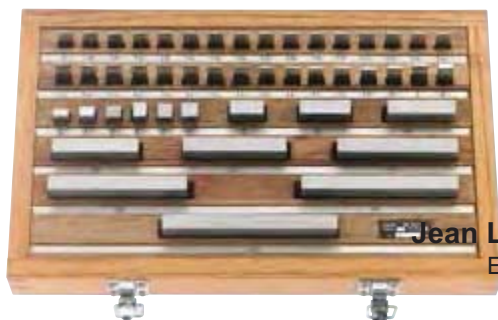

### Specification

- Special steel, hardened
- EN ISO 3650

### Shipment

- Wooden case

**Jean Louis MENEGON** - Votre représentant et Conseiller- Tél. : **06 76 08 96 83**  
 E-mail: [jlouismenegon@aol.com](mailto:jlouismenegon@aol.com) - web: [www.menegon-metrologie.com](http://www.menegon-metrologie.com)

		Pieces per set	Nominal dimensions mm	Increments	Ref. No.	List price Euro
<b>Tolerance class 0</b>						
		103	1.005		0633 014	821.00
			1.01 - 1.49	0.010		
			0.5 - 24.5	0.500		
			25.0 - 100.0	25.000		
		87	1.001 - 1.009	0.001	0633 016	750.00
			1.01 - 1.49	0.010		
			0.5 - 9.5	0.500		
			10.0 - 100.0	10.000		
		47	1.005		0633 018	488.00
			1.01 - 1.09	0.010		
			1.11 - 1.19	0.010		
			1.1 - 1.9	0.100		
			1.0 - 9.0	1.000		
		32	1.005		0633 020	356.00
			1.01 - 1.09	0.010		
			1.1 - 1.9	0.100		
			1.0 - 9.0	1.000		
			10.0 - 30.0	10.000		
<b>Tolerance class 1</b>						
		103	1.005		0633 114	631.00
			1.01 - 1.49	0.010		
			0.5 - 24.5	0.500		
			25.0 - 100.0	25.000		
		87	1.001 - 1.009	0.001	0633 116	481.00
			1.01 - 1.49	0.010		
			0.5 - 9.5	0.500		
			10.0 - 100.0	10.000		
		47	1.005		0633 118	297.00
			1.01 - 1.09	0.010		
			1.11 - 1.19	0.010		
			1.1 - 1.9	0.100		
			1.0 - 9.0	1.000		
		32	1.005		0633 120	217.00
			1.01 - 1.09	0.010		
			1.1 - 1.9	0.100		
			1.0 - 9.0	1.000		
			10.0 - 30.0	10.000		
			50.0			



## 0633 Parallel steel gauge block sets



		Pieces per set	Nominal dimensions mm	Increments	Ref. No.	List price Euro
<b>Tolerance class 2</b>						
		103	1.005		0633 214	399.00
			1.01 - 1.49	0.010		
			0.5 - 24.5	0.500		
			25.0 - 100.0	25.000		
		87	1.001 - 1.009	0.001	0633 216	315.00
			1.01 - 1.49	0.010		
			0.5 - 9.5	0.500		
			10.0 - 100.0	10.000		
		47	1.005		0633 218	216.00
			1.01 - 1.09	0.010		
			1.11 - 1.19	0.010		
			1.1 - 1.9	0.100		
			1.0 - 9.0	1.000		
		32	10.0 - 100.0	10.000	0633 220	142.00
			1.005			
			1.01 - 1.09	0.010		
			1.1 - 1.9	0.100		
			1.0 - 9.0	1.000		
			10.0 - 30.0	10.000		
			50.0			

## 0633 Gauge block accessories sets



0633131

### Shipment

- Wooden case

No. of parts	Gauge block holder (mm)					Radiused measuring jaw pairs (mm)					Scriber	Centre point	Plane parallel jaws (pair)	Knife edge jaws (pair)	Holder base	Ref. No.	List price Euro	
	0-50	0-100	100-200	0-300	200-400	300-500	4	10	16	20								30
4				●		●						●					0633 130	1,064.00
10	●	●	●			●	●					●	●		●		0633 131	1,235.00
14	●	●	●			●	●	●	●			●	●		●		0633 132	1,598.00
23	●	●	●	●	●	●	●	●	●	●	●	●	●	●	●		0633 133	3,156.00

Jean Louis MENEGON - Votre représentant et Conseiller- Tél. : 06 76 08 96 83

E-mail: [jlouismenegon@aol.com](mailto:jlouismenegon@aol.com) - web: [www.menegon-metrologie.com](http://www.menegon-metrologie.com)





0633 Gauge block holders with rapid adjustment



⊗	📏	For meas. range mm	Ref. No.	List price Euro
		0 - 50	0633 136	148.00
		0 - 100	0633 137	168.00
		0 - 200	0633 138	200.00
		100 - 200	0633 139	182.00
		100 - 300	0633 140	217.00
		200 - 400	0633 141	251.00
		300 - 500	0633 142	285.00
		400 - 600	0633 143	309.00
		500 - 800	0633 144	360.00
		800 - 1000	0633 145	503.00

0633 Radiused measuring jaws with cylindrical shoulders / pair



⊗	📏	Nominal dimension mm	Measuring depth mm	Ref. No.	List price Euro
		4	8	0633 150	170.00
		10	15	0633 151	170.00
		16	20	0633 152	185.00
		20	40	0633 153	226.00
		30	65	0633 154	319.00
		40	95	0633 155	414.00

0633 Inspection points, pair



Specification

- Special steel, hardened

⊗	📏	Dimensions L x W x H mm	Ref. No.	List price Euro
		55 x 9 x 9	0633 170	179.00

0633 Scribers



Specification

- Special steel, hardened or carbide

⊗	📏	Dimensions L x W x H mm	Ref. No.	List price Euro
<b>Special steel</b>				
		55 x 9 x 8	0633 171	74.00
<b>Carbide</b>				
		55 x 9 x 8	0633 172	301.00

0633 Centre point



Specification

- Special steel, hardened

⊗	📏	Dimensions L x W x H mm	Ref. No.	List price Euro
		55 x 9 x 12	0633 173	98.00

Jean Louis MENEGON - Votre représentant et Conseiller- Tél. : 06 76 08 96 83

E-mail: [jlouismenegon@aol.com](mailto:jlouismenegon@aol.com) - web: [www.menegon-metrologie.com](http://www.menegon-metrologie.com)



## 0633 Plane / parallel jaws, pair



## Specification

- Special steel, hardened

		Dimensions L x B x H mm	Ref. No.	List price Euro
<b>For external measurements</b>				
		100 x 9 x 20	0633 174	168.00
		125 x 9 x 20	0633 175	197.00
<b>For internal and external measurements</b>				
		100 x 9 x 20	0633 176	310.00
		125 x 9 x 20	0633 177	366.00

## 0633 Knife edge jaws, pair



## Specification

- Special steel, hardened

		Total length mm	Max. measured dia. mm	Ref. No.	List price Euro
		55	26	0633 178	179.00
		65	50	0633 179	227.00
		90	100	0633 180	272.00
		140	200	0633 181	404.00

## 0633 Stand for gauge block holder

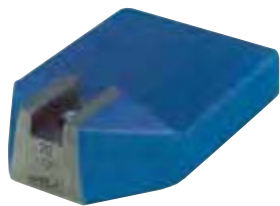

## Specification

- Special steel, hardened

		Dimensions L x W x H	Ref. No.	List price Euro
		103 x 70 x 27	0633 182	132.00

## 0633 Gauge block maintenance set



## Set consists of:

- Linen cloth
- Chamois leather
- 1 jar of anti corrosion oil
- Oil stone
- Fine paint brush
- Broad paint brush
- User manual

## Shipment

- Wooden case

		Ref. No.	List price Euro
		0633 001	290.00

Jean Louis MENEGON - Votre représentant et Conseiller- Tél. : 06 76 08 96 83

E-mail: [jlouismenegon@aol.com](mailto:jlouismenegon@aol.com) - web: [www.menegon-metrologie.com](http://www.menegon-metrologie.com)



0633 Steel gauge block inspection sets for micrometers



0633 810

Specification

- EN ISO 3650
- Special steel, hardened
- Tolerance class 1

Shipment

- Wooden case

		Nominal dimensions mm	Ref. No.	List price Euro
<b>5 pieces with optical flat</b>				
		5.1 - 10.3 - 15.0 - 20.2 - 25.0	0633 805	313.00
<b>8 pieces with optical flat</b>				
		5.1 - 10.3 - 15.0 - 20.2 - 25.0 - 50.0 - 75.0 - 100.0	0633 808	419.00
<b>10 pieces, excludes the optical flat</b>				
		2.5 - 5.1 - 7.7 - 10.3 - 12.9 - 15.0 - 17.6 - 20.2 - 22.8 - 25.0	0633 810	254.00

0633 Steel gauge block inspection set for calipers



Specification

- EN ISO 3650
- Special steel, hardened
- Tolerance class 1
- Supplied with:  
setting rings 4 mm and  
25 mm

Shipment

- Wooden case

		Nominal dimensions mm	For calipers with a measuring range up to mm	Ref. No.	List price Euro
<b>3 pieces</b>					
		30.0 - 41.3 - 131.4	200	0633 833	520.00
<b>4 pieces</b>					
		30.0 - 41.3 - 131.4 - 243.5	300	0633 834	694.00
<b>6 pieces</b>					
		30.0 - 41.3 - 131.4 - 243.5 - 281.2 - 481.1	500	0633 836	1,239.00

Jean Louis MENEGON - Votre représentant et Conseiller- Tél. : 06 76 08 96 83

E-mail: [jlouismenegon@aol.com](mailto:jlouismenegon@aol.com) - web: [www.menegon-metrologie.com](http://www.menegon-metrologie.com)





## 0634 Carbide gauge block sets

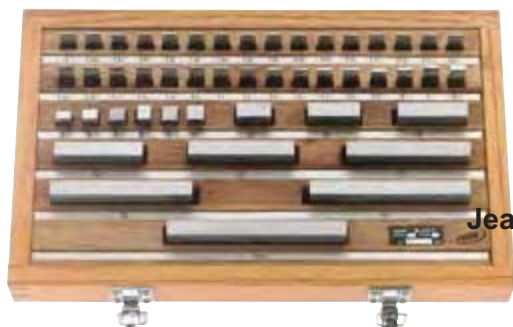

## Specification

- Carbide
- EN ISO 3650

## Shipment

- Wooden case

Jean Louis MENEGON - Votre représentant et Conseiller- Tél. : 06 76 08 96 83

E-mail: [jlouismenegon@aol.com](mailto:jlouismenegon@aol.com) - web: [www.menegon-metrologie.com](http://www.menegon-metrologie.com)

		Pieces per set	Nominal dimensions mm	Increments	Ref. No.	List price Euro
<b>Tolerance class 0</b>						
		103	1.005		0634 014	4,224.00
			1.01 - 1.49	0.010		
			0.5 - 24.5	0.500		
			25.0 - 100.0	25.000		
		87	1.001 - 1.009	0.001	0634 016	3,480.00
			1.01 - 1.49	0.010		
			0.5 - 9.5	0.500		
			10.0 - 100.0	10.000		
		47	1.005		0634 017	2,274.00
			1.01 - 1.09	0.010		
			1.11 - 1.19	0.010		
			1.1 - 1.9	0.100		
			1.0 - 9.0	1.000		
		32	1.005		0634 020	1,194.00
			1.01 - 1.09	0.010		
			1.1 - 1.9	0.100		
			1.0 - 9.0	1.000		
			10.0 - 30.0	10.000		
<b>Tolerance class 1</b>						
		103	1.005		0634 114	3,718.00
			1.01 - 1.49	0.010		
			0.5 - 24.5	0.500		
			25.0 - 100.0	25.000		
		87	1.001 - 1.009	0.001	0634 116	3,039.00
			1.01 - 1.49	0.010		
			0.5 - 9.5	0.500		
			10.0 - 100.0	10.000		
		47	1.005		0634 117	2,038.00
			1.01 - 1.09	0.010		
			1.11 - 1.19	0.010		
			1.1 - 1.9	0.100		
			1.0 - 9.0	1.000		
		32	1.005		0634 120	1,037.00
			1.01 - 1.09	0.010		
			1.1 - 1.9	0.100		
			1.0 - 9.0	1.000		
			10.0 - 30.0	10.000		
			50.0			



## 0634 Ceramic gauge block sets



### Specification

- Ceramic
- EN ISO 3650

### Shipment

- Wooden case

**Jean Louis MENEGON** - Votre représentant et Conseiller- Tél. : 06 76 08 96 83  
 E-mail: [jlouismenegon@aol.com](mailto:jlouismenegon@aol.com) - web: [www.menegon-metrologie.com](http://www.menegon-metrologie.com)

		Pieces per set	Nominal dimensions mm	Increments	Ref. No.	List price Euro
<b>Tolerance class 0</b>						
		103	1.005		0634 514	5,898.00
			1.01 - 1.49	0.010		
			0.5 - 24.5	0.500		
			25.0 - 100.0	25.000		
		87	1.001 - 1.009	0.001	0634 516	4,697.00
			1.01 - 1.49	0.010		
			0.5 - 9.5	0.500		
			10.0 - 100.0	10.000		
		47	1.005		0634 517	2,801.00
			1.01 - 1.09	0.010		
			1.11 - 1.19	0.010		
			1.1 - 1.9	0.100		
			1.0 - 9.0	1.000		
		32	1.005		0634 520	1,701.00
			1.01 - 1.09	0.010		
			1.1 - 1.9	0.100		
			1.0 - 9.0	1.000		
			10.0 - 30.0	10.000		
			50.0			
<b>Tolerance class 1</b>						
		103	1.005		0634 614	4,937.00
			1.01 - 1.49	0.010		
			0.5 - 24.5	0.500		
			25.0 - 100.0	25.000		
		87	1.001 - 1.009	0.001	0634 616	3,924.00
			1.01 - 1.49	0.010		
			0.5 - 9.5	0.500		
			10.0 - 100.0	10.000		
		47	1.005		0634 617	2,341.00
			1.01 - 1.09	0.010		
			1.11 - 1.19	0.010		
			1.1 - 1.9	0.100		
			1.0 - 9.0	1.000		
		32	1.005		0634 620	1,419.00
			1.01 - 1.09	0.010		
			1.1 - 1.9	0.100		
			1.0 - 9.0	1.000		
			10.0 - 30.0	10.000		
			50.0			



## 0636 Set of pin gauges



### Specification

- Made out of high quality gauge steel

### Shipment

- Wooden case

**DIN  
2269**

		Pieces per	Length mm	Increments mm	Nominal dimension mm	Tolerance class	Ref. No.	List price Euro
<b>Special steel, hardened and aged</b>								
		51	40	0.01	0.5 - 1.0	1	0636 301	750.00
		21	70	0.05	1.0 - 2.0	1	0636 321	227.00
		21	70	0.05	2.0 - 3.0	1	0636 322	227.00
		21	70	0.05	3.0 - 4.0	1	0636 323	281.00
		21	70	0.05	4.0 - 5.0	1	0636 324	281.00
		21	70	0.05	5.0 - 6.0	1	0636 325	281.00
		21	70	0.05	6.0 - 7.0	1	0636 326	343.00
		21	70	0.05	7.0 - 8.0	1	0636 327	343.00
		21	70	0.05	8.0 - 9.0	1	0636 328	343.00
		21	70	0.05	9.0 - 10.0	1	0636 329	343.00
<b>Special steel, hardened and aged</b>								
		101	70	0.01	1.0 - 2.0	1	0636 341	955.00
		100	70	0.01	2.01 - 3.0	1	0636 342	955.00
		100	70	0.01	3.01 - 4.0	1	0636 343	1,210.00
		100	70	0.01	4.01 - 5.0	1	0636 344	1,210.00
		100	70	0.01	5.01 - 6.0	1	0636 345	1,210.00
		100	70	0.01	6.01 - 7.0	1	0636 346	1,489.00
		100	70	0.01	7.01 - 8.0	1	0636 347	1,489.00
		100	70	0.01	8.01 - 9.0	1	0636 348	1,489.00
		100	70	0.01	9.01 - 10.0	1	0636 349	1,489.00
		91	70	0.10	1.0 - 10.0	1	0636 351	1,220.00
		81	70	0.05	1.0 - 5.00	1	0636 352	1,109.00
<b>Special steel, hardened and aged</b>								
		101	70	0.01	1.0 - 2.0	2	0636 372	668.00
		100	70	0.01	2.01 - 3.0	2	0636 373	668.00
		100	70	0.01	3.01 - 4.0	2	0636 374	880.00
		100	70	0.01	4.01 - 5.0	2	0636 375	880.00
		100	70	0.01	5.01 - 6.0	2	0636 376	880.00
		100	70	0.01	6.01 - 7.0	2	0636 377	1,065.00
		100	70	0.01	7.01 - 8.0	2	0636 378	1,208.00
		100	70	0.01	8.01 - 9.0	2	0636 379	1,208.00
		100	70	0.01	9.01 - 10.0	2	0636 380	1,208.00

Jean Louis MENEGON - Votre représentant et Conseiller- Tél. : 06 76 08 96 83

E-mail: [jlouismenegon@aol.com](mailto:jlouismenegon@aol.com) - web: [www.menegon-metrologie.com](http://www.menegon-metrologie.com)





0636 Pin gauge holder



Specification

- Die cast
- Locking screw

		For meas. range mm	Length of holder mm	Ref. No.	List price Euro
		1 - 2	60	0636 392	12.20
		2 - 4	68	0636 393	14.00
		4 - 6	76	0636 394	26.50
		6 - 8	84	0636 395	34.00
		8 - 10	92	0636 396	39.20



## 0637 Plug gauges



## Specification

- Manufacturing tolerances: according to DIN 7150-2 and DIN 7164
- Fit H7
- All cylindrical
- Special dimensions with other tolerances are available upon request

		Nominal dimension dia. mm	Dimensions acc. DIN	Ref. No.	List price Euro
		<b>Gauge steel, hardened</b>			
		2	2245-1	0637 103	28.70
		2.2	2245-1	0637 104	28.70
		2.5	2245-1	0637 105	28.70
		2.8	2245-1	0637 106	20.90
		3	2245-1	0637 107	20.90
		3.5	2245-1	0637 108	18.70
		4	2245-1	0637 109	18.70
		4.5	2245-1	0637 110	18.70
		5	2245-1	0637 111	17.60
		6	2245-1	0637 112	17.60
		7	2245-1	0637 113	18.70
		8	2245-1	0637 114	18.70
		9	2245-1	0637 115	19.90
		10	2245-1	0637 116	20.90
		11	2245-1	0637 117	20.90
		12	2245-1	0637 118	22.10
		13	2245-1	0637 119	23.20
		14	2245-1	0637 120	23.20
		15	2245-1	0637 121	23.90
		16	2245-1	0637 122	23.90
		17	2245-1	0637 123	24.90
		18	2245-1	0637 124	25.90
		19	2245-1	0637 125	25.90
		20	2245-1	0637 126	25.90
		21	2245-1	0637 127	27.20
		22	2245-1	0637 128	27.80
		23	2245-1	0637 129	28.70
		24	2245-1	0637 130	28.70
		25	2245-1	0637 131	29.80
		26	2245-1	0637 132	31.00
		27	2245-1	0637 133	31.00
		28	2245-1	0637 134	32.00
		30	2245-1	0637 135	32.00
		32	2245-1	0637 136	35.40
		33	2245-1	0637 137	36.00
		34	2245-1	0637 138	37.10
		35	2245-1	0637 139	37.10
		36	2245-1	0637 140	37.90
		37	2245-1	0637 141	38.70
		38	2245-1	0637 142	39.80
		40	2245-1	0637 144	41.00
		42	2245-2	0637 146	42.30
		43	2245-2	0637 147	52.00
		44	2245-2	0637 148	45.40
		45	2245-2	0637 149	46.40

Jean Louis MENEGON - Votre représentant et Conseiller- Tél. : 06 76 08 96 83

E-mail: [jlouismenegon@aol.com](mailto:jlouismenegon@aol.com) - web: [www.menegon-metrologie.com](http://www.menegon-metrologie.com)





## 0637 Plug gauges



### Specification

- Manufacturing tolerances: according to DIN 7150-2 and DIN 7164
- Fit H7
- All cylindrical
- Special dimensions with other tolerances are available upon request

		Nominal dimension dia. mm	Dimensions acc. DIN	Ref. No.	List price Euro
<b>Gauge steel, hardened</b>					
		46	2245-2	0637 150	47.10
		47	2245-2	0637 151	49.40
		48	2245-2	0637 152	50.00
		50	2245-2	0637 154	52.00
		52	2245-2	0637 155	55.00
		55	2245-2	0637 156	58.00
		58	2245-2	0637 157	62.00
		60	2245-2	0637 158	64.00
		62	2245-2	0637 159	67.00
		65	2245-2	0637 160	67.00
		68	2245-2	0637 161	74.00
		70	2245-2	0637 162	75.00
		72	2245-2	0637 163	77.00
		75	2245-2	0637 164	81.00
		78	2245-2	0637 165	85.00
		80	2245-2	0637 166	86.00
		82	2245-2	0637 167	88.00
		85	2245-2	0637 168	91.00
		88	2245-2	0637 169	96.00
		90	2245-2	0637 170	97.00
		92	2245-2	0637 171	100.00
		95	2245-2	0637 172	102.00
		98	2245-2	0637 173	105.00
		100	2245-2	0637 174	107.00

## 0637 Plug gauge set



DIN  
2245

6

### Specification

- DIN 2245
- Hardened gauge steel
- GO and NOGO
- Fit H7

### Shipment

- Wooden case

		Nominal dimensions mm	Ref. No.	List price Euro
7 pieces (3 - 12 mm)		3 - 4 - 5 - 6 - 8 - 10 - 12	0637 190	137.00

Jean Louis MENEGON - Votre représentant et Conseiller- Tél. : 06 76 08 96 83

E-mail: [jlouismenegon@aol.com](mailto:jlouismenegon@aol.com) - web: [www.menegon-metrologie.com](http://www.menegon-metrologie.com)



### 0643 Snap gauge, double jaw



#### Specification

- Dimensions 3 to 100 mm
- Gauge steel
- Hardened measuring faces
- Dimensions acc. DIN 2230
- Manufacturing tolerances: according to DIN 7163

#### Shipment

- Available on request
- Important: Please mention dimension and fit

### 0649 Adjustable snap gauges



#### Specification

- Die cast
- 1 fixed measuring face and 2 adjustable square measuring faces

#### Shipment

- Cardboard box

		Nominal dimension dia. mm	Ref. No.	List price Euro
		0 - 6	0649 201	66.00
		6 - 13	0649 202	66.00
		13 - 19	0649 203	66.00
		19 - 26	0649 204	68.00
		26 - 32	0649 205	68.00
		32 - 38	0649 206	72.00
		38 - 44	0649 207	72.00
		44 - 51	0649 208	75.00
		51 - 57	0649 209	75.00
		57 - 64	0649 210	79.00

		Nominal dimension dia. mm	Ref. No.	List price Euro
		64 - 70	0649 211	79.00
		70 - 78	0649 212	86.00
		78 - 87	0649 213	86.00
		87 - 97	0649 215	95.00
		97 - 106	0649 216	109.00
		106 - 116	0649 217	109.00
		116 - 125	0649 219	130.00
		125 - 135	0649 220	169.00
		135 - 144	0649 222	194.00
		144 - 156	0649 223	194.00

Jean Louis MENEGON - Votre représentant et Conseiller- Tél. : 06 76 08 96 83  
 E-mail: [jlouismenegon@aol.com](mailto:jlouismenegon@aol.com) - web: [www.menegon-metrologie.com](http://www.menegon-metrologie.com)



## 0650 Adjustable snap gauges



0650 103

### Specification

- Adjustable
- Light alloy cast frame
- Carbide tipped measuring faces
- Without indicator
- Up to 100 mm with centering support and lift-off device. Snap gauges above 100 mm, excludes centring support and lift-off device.

### Shipment

- Cardboard box
- Dial indicator not included



0650 114

⏏	📄	Measuring range dia. mm	Measuring jaws mm	Ref. No.	List price Euro
		0 - 25	15 x 15	0650 101	844.00
		25 - 50	15 x 15	0650 102	922.00
		50 - 75	15 x 15	0650 103	1,013.00
		75 - 100	15 x 15	0650 104	1,110.00
		100 - 150	40 x 18	0650 105	1,599.00
		150 - 200	40 x 18	0650 106	1,809.00
		200 - 250	40 x 18	0650 107	2,075.00
		250 - 300	40 x 18	0650 108	2,161.00
		300 - 350	40 x 18	0650 109	2,293.00
		350 - 400	40 x 18	0650 110	2,481.00
		400 - 450	40 x 18	0650 111	2,663.00
		450 - 500	40 x 18	0650 112	2,846.00
		500 - 550	40 x 18	0650 113	3,030.00
		550 - 600	40 x 18	0650 114	3,274.00
		600 - 650	40 x 18	0650 115	4,183.00
		650 - 700	40 x 18	0650 116	4,363.00
		700 - 750	40 x 18	0650 117	4,553.00
		750 - 800	40 x 18	0650 118	4,739.00
		800 - 850	40 x 18	0650 119	4,924.00

Jean Louis MENEGON - Votre représentant et Conseiller- Tél. : 06 76 08 96 83

E-mail: [jlouismenegon@aol.com](mailto:jlouismenegon@aol.com) - web: [www.menegon-metrologie.com](http://www.menegon-metrologie.com)





Jean Louis MENEGON - Votre représentant et Conseiller- Tél. : 06 76 08 96 83

E-mail: [jlouismenegon@aol.com](mailto:jlouismenegon@aol.com) - web: [www.menegon-metrologie.com](http://www.menegon-metrologie.com)

## 0656 Ring gauges



## Specification

DIN  
2250-1

- Hardened gauge steel,
- DIN 2250-1 (C)
- For setting internal measuring instruments

⊠	⚙	Nominal dimension dia. mm	Ref. No.	List price Euro	⊠	⚙	Nominal dimension dia. mm	Ref. No.	List price Euro
		3	0656 309	53.00			52	0656 353	88.00
		3.5	0656 310	46.40			55	0656 354	96.00
		4	0656 311	46.40			58	0656 355	100.00
		4.5	0656 312	46.40			60	0656 356	104.00
		5	0656 313	45.40			62	0656 357	107.00
		6	0656 314	44.30			65	0656 358	114.00
		7	0656 315	44.30			68	0656 359	122.00
		8	0656 316	44.30			70	0656 360	126.00
		9	0656 317	44.30			72	0656 361	131.00
		10	0656 318	44.30			75	0656 362	135.00
		11	0656 319	45.40			78	0656 363	142.00
		12	0656 320	46.40			80	0656 364	147.00
		12.5	0656 303	46.40			82	0656 365	155.00
		13	0656 321	47.10			85	0656 366	166.00
		14	0656 322	47.10			88	0656 367	176.00
		15	0656 323	48.30			90	0656 368	182.00
		16	0656 324	48.30			92	0656 369	190.00
		17	0656 325	49.40			95	0656 370	202.00
		17.5	0656 304	69.00			98	0656 371	212.00
		18	0656 326	49.40			100	0656 372	218.00
		19	0656 327	50.00			105	0656 373	229.00
		20	0656 328	52.00			110	0656 374	241.00
		21	0656 329	52.00			115	0656 375	251.00
		22	0656 330	52.00			120	0656 376	263.00
		23	0656 331	55.00			125	0656 377	274.00
		24	0656 332	56.00			130	0656 378	284.00
		25	0656 333	57.00			135	0656 379	295.00
		26	0656 334	58.00			140	0656 380	306.00
		27	0656 335	58.00			145	0656 381	317.00
		28	0656 336	59.00			150	0656 382	328.00
		30	0656 337	55.00			155	0656 383	358.00
		32	0656 338	62.00			160	0656 384	387.00
		33	0656 339	62.00			165	0656 385	416.00
		34	0656 340	63.00			170	0656 386	447.00
		35	0656 341	63.00			175	0656 387	476.00
		36	0656 342	64.00			180	0656 388	505.00
		37	0656 343	65.00			185	0656 389	536.00
		38	0656 344	66.00			190	0656 390	564.00
		40	0656 345	67.00			195	0656 391	595.00
		42	0656 346	71.00			200	0656 392	624.00
		44	0656 347	75.00			210	0656 393	657.00
		45	0656 348	77.00			220	0656 394	686.00
		46	0656 349	79.00			225	0656 305	825.00
		47	0656 350	81.00			230	0656 395	719.00
		48	0656 351	83.00			240	0656 396	751.00
		50	0656 352	86.00			250	0656 397	783.00
							260	0656 398	815.00
							270	0656 399	846.00
							275	0656 306	908.00



0658 Thread plug gauges



DIN 2280

Specification

- DIN 2280
- For standard metric ISO threads DIN 13
- Gauge steel, hardened
- Fit 6H (\* 5H)

Jean Louis MENEGON - Votre représentant et Conseiller- Tél. : 06 76 08 96 83

E-mail: [jlouismenegon@aol.com](mailto:jlouismenegon@aol.com) - web: [www.menegon-metrologie.com](http://www.menegon-metrologie.com)

		Thread size M	Ref. No.	List price Euro			Thread size M	Ref. No.	List price Euro
		1.0 x 0.25*	0658 001	137.00			14.0 x 2.00	0658 020	71.00
		1.2 x 0.25*	0658 002	132.00			16.0 x 2.00	0658 021	77.00
		1.4 x 0.30*	0658 003	115.00			18.0 x 2.50	0658 022	82.00
		1.6 x 0.35	0658 004	100.00			20.0 x 2.50	0658 023	87.00
		1.8 x 0.35	0658 005	88.00			22.0 x 2.50	0658 024	93.00
		2.0 x 0.40	0658 006	88.00			24.0 x 3.00	0658 025	104.00
		2.2 x 0.45	0658 007	81.00			27.0 x 3.00	0658 026	114.00
		2.5 x 0.45	0658 008	76.00			30.0 x 3.50	0658 027	127.00
		3.0 x 0.50	0658 009	63.00			33.0 x 3.50	0658 028	138.00
		3.5 x 0.60	0658 010	62.00			36.0 x 4.00	0658 029	150.00
		4.0 x 0.70	0658 011	59.00			39.0 x 4.00	0658 030	166.00
		5.0 x 0.80	0658 012	58.00			42.0 x 4.50	0658 031	244.00
		6.0 x 1.00	0658 013	56.00			45.0 x 4.50	0658 032	264.00
		7.0 x 1.00	0658 014	57.00			48.0 x 5.00	0658 033	285.00
		8.0 x 1.25	0658 015	58.00			52.0 x 5.00	0658 034	305.00
		9.0 x 1.25	0658 016	59.00			56.0 x 5.50	0658 035	338.00
		10.0 x 1.50	0658 017	62.00			60.0 x 5.50	0658 036	358.00
		11.0 x 1.50	0658 018	97.00			64.0 x 6.00	0658 037	392.00
		12.0 x 1.75	0658 019	66.00			68.0 x 6.00	0658 038	417.00

0658 Set of thread plug gauges



DIN 2280

6

Specification

- DIN 2280
- Hardened gauge steel
- For standard metric ISO threads DIN 13
- GO and NOGO
- Fit 6H

Shipment

- Wooden case

		Nominal dimensions mm	Ref. No.	List price Euro
7 pieces (M3 - M12 mm)				
		M3 - M4 - M5 - M6 - M8 - M10 - M12	0658 090	233.00



Jean Louis MENEGON - Votre représentant et Conseiller- Tél. : 06 76 08 96 83

E-mail: [jlouismenegon@aol.com](mailto:jlouismenegon@aol.com) - web: [www.menegon-metrologie.com](http://www.menegon-metrologie.com)

## 0658 Thread ring gauges

DIN  
2285-1DIN  
2299-1

## Specification

- **GO thread ring gauge**
- For standard metric ISO threads DIN 13
- Hardened gauge steel
- DIN 2285-1
- Fit 6g (\* 6h)

## Specification

- **NOGO thread ring gauge**
- For standard metric ISO threads DIN 13
- Hardened gauge steel
- DIN 2299-1
- Fit 6g (\* 6h)

		Thread size M	Ref. No.	List price Euro
		1.0 x 0.25*	0658 501	138.00
		1.2 x 0.25*	0658 502	131.00
		1.4 x 0.30*	0658 503	121.00
		1.6 x 0.35*	0658 504	88.00
		1.8 x 0.35*	0658 505	80.00
		2.0 x 0.40*	0658 506	80.00
		2.2 x 0.45	0658 507	69.00
		2.5 x 0.45	0658 508	60.00
		3.0 x 0.50	0658 509	49.40
		3.5 x 0.60	0658 510	46.40
		4.0 x 0.70	0658 511	45.40
		5.0 x 0.80	0658 512	45.40
		6.0 x 1.00	0658 513	45.40
		7.0 x 1.00	0658 514	45.40
		8.0 x 1.25	0658 515	46.40
		9.0 x 1.25	0658 516	49.40
		10.0 x 1.50	0658 517	55.00
		11.0 x 1.50	0658 518	62.00
		12.0 x 1.75	0658 519	64.00
		14.0 x 2.00	0658 520	69.00
		16.0 x 2.00	0658 521	77.00
		18.0 x 2.50	0658 522	88.00
		20.0 x 2.50	0658 523	98.00
		22.0 x 2.50	0658 524	106.00
		24.0 x 3.00	0658 525	114.00
		27.0 x 3.00	0658 526	128.00
		30.0 x 3.50	0658 527	138.00
		33.0 x 3.50	0658 528	152.00
		36.0 x 4.00	0658 529	163.00
		39.0 x 4.00	0658 530	177.00
		42.0 x 4.50	0658 531	193.00
		45.0 x 4.50	0658 532	204.00
		48.0 x 5.00	0658 533	216.00
		52.0 x 5.00	0658 534	234.00
		56.0 x 5.50	0658 535	247.00
		60.0 x 5.50	0658 536	264.00
		64.0 x 6.00	0658 537	283.00
		68.0 x 6.00	0658 538	299.00

		Thread size M	Ref. No.	List price Euro
		1.0 x 0.25*	0658 601	138.00
		1.2 x 0.25*	0658 602	131.00
		1.4 x 0.30*	0658 603	121.00
		1.6 x 0.35*	0658 604	88.00
		1.8 x 0.35*	0658 605	80.00
		2.0 x 0.40*	0658 606	80.00
		2.2 x 0.45	0658 607	69.00
		2.5 x 0.45	0658 608	60.00
		3.0 x 0.50	0658 609	49.40
		3.5 x 0.60	0658 610	46.40
		4.0 x 0.70	0658 611	45.40
		5.0 x 0.80	0658 612	45.40
		6.0 x 1.00	0658 613	45.40
		7.0 x 1.00	0658 614	45.40
		8.0 x 1.25	0658 615	46.40
		9.0 x 1.25	0658 616	49.40
		10.0 x 1.50	0658 617	55.00
		11.0 x 1.50	0658 618	63.00
		12.0 x 1.75	0658 619	64.00
		14.0 x 2.00	0658 620	69.00
		16.0 x 2.00	0658 621	77.00
		18.0 x 2.50	0658 622	88.00
		20.0 x 2.50	0658 623	98.00
		22.0 x 2.50	0658 624	106.00
		24.0 x 3.00	0658 625	114.00
		27.0 x 3.00	0658 626	128.00
		30.0 x 3.50	0658 627	138.00
		33.0 x 3.50	0658 628	152.00
		36.0 x 4.00	0658 629	163.00
		39.0 x 4.00	0658 630	177.00
		42.0 x 4.50	0658 631	193.00
		45.0 x 4.50	0658 632	204.00
		48.0 x 5.00	0658 633	216.00
		52.0 x 5.00	0658 634	234.00
		56.0 x 5.50	0658 635	247.00
		60.0 x 5.50	0658 636	264.00
		64.0 x 6.00	0658 637	283.00
		68.0 x 6.00	0658 638	299.00





0658 Set of GO thread ring gauges



DIN  
2285-1

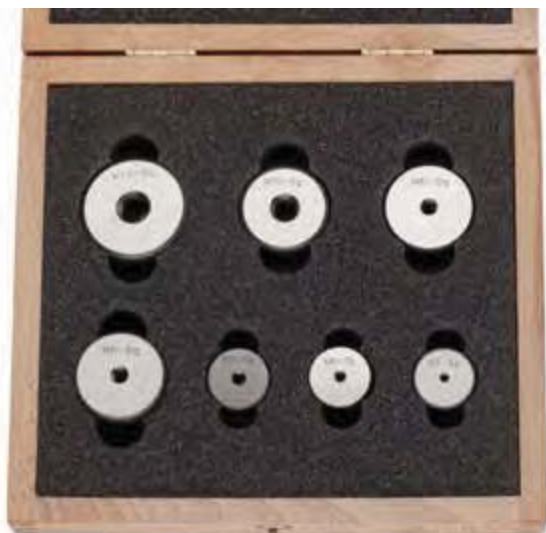

Specification

- M3 - M12, 7 pieces
- Hardened gauge steel
- For standard metric ISO threads DIN 13
- Fit 6g

Shipment

- Wooden case

Icon	Icon	Fit	Ref. No.	List price Euro
		M3 - M12 (M3, M4, M5, M6, M8, M10, M12)	0658 590	233.00
		6g		

0658 Set of NOGO thread ring gauges



DIN  
2299-1



Specification

- M3 - M12, 7 pieces
- Hardened gauge steel
- For standard metric ISO threads DIN 13
- Fit 6g

Shipment

- Wooden case

Icon	Icon	Fit	Ref. No.	List price Euro
		M3 - M12 (M3, M4, M5, M6, M8, M10, M12)	0658 690	233.00
		6g		



[www.menegon-metrologie.com](http://www.menegon-metrologie.com)

## PERFECTION IN THE DETAIL

Quality has its price and with us this is more than recompensed. We achieve this through efficient structures and with exceptional service and ideas, all combined with classic hard-working German precision and quality.

With the appropriate sensitivity to saving and investment, we develop sophisticated portable measuring devices to the highest standards. With these superb products, we offer our partners and clients the best conditions for efficient working.

We are happy that the next generation will be able to continue a tradition in which we are happy to invest: we are training clever people today, who will be there tomorrow to provide you with advice and practical help.



**Jean Louis MENEGON** - Votre représentant et Conseiller- Tél. : 06 76 08 96 83  
E-mail: [jlouismenegon@aol.com](mailto:jlouismenegon@aol.com) - web: [www.menegon-metrologie.com](http://www.menegon-metrologie.com)

## 7. CHAPTER DATA TRANSMISSION

270	Data cables
270	Software
271	Accessories for data acquisition
272	USB-keyboard interface
273	Wireless data transmission
274	Overview data cables





Jean Louis MENEGON - Votre représentant et Conseiller- Tél. : 06 76 08 96 83

E-mail: [jlouismenegon@aol.com](mailto:jlouismenegon@aol.com) - web: [www.menegon-metrologie.com](http://www.menegon-metrologie.com)

## 1997 / 1998 Data cable for variable data output



DATA VARIABLE plug to the device

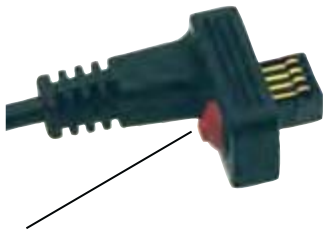

**DATA-button** on the plug-in jack: to transfer the measured results to a PC, laptop or keyboard-interface

Interfaces



- 1 USB (incl. software MarCom Standard)
- 2 Opto RS 232
- 3 Digimatic



1998 720

1997 501



1998 501

Specification

- Available for all DIGI-MET® measuring instruments with a variable data output (DATA VARIABLE)
- Length 2 m
- With a data transfer button on the plug-in jack
- USB-data cable No. 1998 720 incl. software MarCom standard to transfer the measured results to applications, e.g. EXCEL®

	Ref. No.	List price Euro
Cable for USB incl. software MarCom standard	1998 720	66.00
Cable for RS 232	1997 501	46.20
Cable for Digimatic	1998 501	59.00

## 1998 Software MarCom



Specification

Software for easy data acquisition, for all measuring instruments with variable data output (DATA VARIABLE)

**MarCom Standard\* (No. 1998712)**

- Data transfer directly to MS EXCEL® (from version 97), text file or keyboard code
- Connection of one measuring instrument via USB plus one serial COM-interface possible
- Measured results can be transferred to separate Excel columns, -tables or folders
- Clear indication of the selected measuring instruments
- Flexible and comfortable data transmission, optional via „data“-button on the measuring instrument or the data cable or the PC keyboard, timer or foot-switch (optional)

**MarCom Professional (No. 1998710) with additional equipment:**

- Connection to more than 100 measuring instruments with USB data cable possible
- Data transmission with virtual interface box MUX 50 format possible
- Connection of two serial COM-interfaces possible
- Several foot switch via USB connectable, the measuring instruments can be freely assigned
- USB Hubs connectable as measuring instrument interface
- Wireless data transfer via **blueDAT** (see page No. 273)

**System requirements:**

IBM AT compatible PC, MS Windows 7 / 8, USB-interface from version 2.0  
MS EXCEL® from version 97



	Ref. No.	List price Euro
MarCom Standard	1998 712	56.00
MarCom Professional	1998 710	222.00

\* Please note, this software is already included with the USB data cable 1998 720.



## 1998 Accesories for data aquisition with MarCom



Example: possible measuring station setup

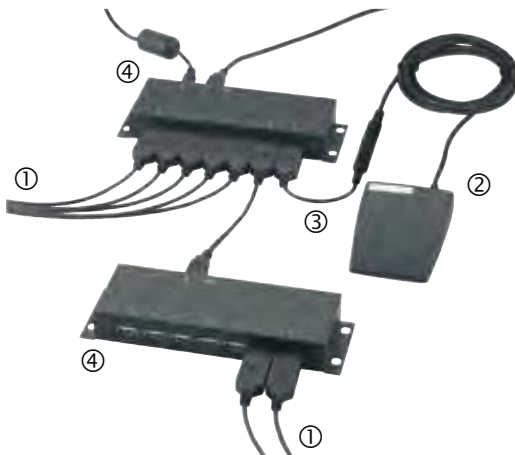

Specification

- ① USB-cable to devices
- ② Foot switch with jack plug
- ③ USB-adapter-cable for foot switch
- ④ USB-hub for connecting several devices



	Ref. No.	List price Euro
Data cable for USB incl. software MarCom Standard	1998 720	66.00
Foot-switch* (length of the cable 2 m)	1998 732	66.00
USB-adapter cable for foot switch	1998 722	56.00
USB-hub sevenfold with plug-in power supply	1998 730	111.00

\* To connect to the MarCom, the USB-adapter cable Ref. No. 1998 722 is required

## 0996 Data cable for data output Opto RS 232



0996 701



0996 705



	Ref. No.	List price Euro
Cable for Opto to RS 232	0996 701	71.00
Cable for Opto to USB	0996 705	136.00

Jean Louis MENEGON - Votre représentant et Conseiller- Tél. : 06 76 08 96 83

E-mail: [jlouismenegon@aol.com](mailto:jlouismenegon@aol.com) - web: [www.menegon-metrologie.com](http://www.menegon-metrologie.com)





Jean Louis MENEGON - Votre représentant et Conseiller- Tél. : 06 76 08 96 83

E-mail: [jlouismenegon@aol.com](mailto:jlouismenegon@aol.com) - web: [www.menegon-metrologie.com](http://www.menegon-metrologie.com)

## 0997 USB-keyboard interface cable

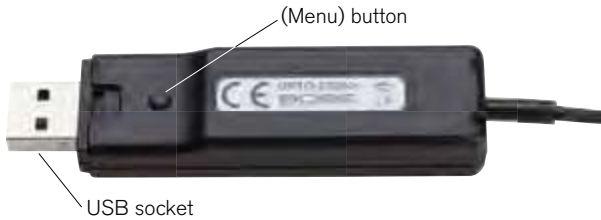

### Specification

- USB-keyboard interface and data cable are in one unit (length of the cable 2 m)
- For connection of one unit
- Power supply via USB interface
- No driver file for the USB interface required
- The USB interface reveal themselves as a keyboard
- Terminators like Enter or Tab can be adjusted in the USB interface
- More settings such as language, separator and timer
- Transmission of data either through the data-switch on measuring instrument or with a timer



### Plug connection to the device



	Ref. No.	List price Euro
① USB-keyboard interface cable Opto RS 232	0997 770	232.00
② *USB-keyboard interface cable RS 232 Proximity	0997 772	232.00
③ *USB-keyboard interface cable RS 232 Power (Power supply through data cable)	0997 774	283.00

\* For using with indicators No. 0691, see page 123

## 0997 USB-keyboard interface "T-Box 302 USB"



### Specification

- USB-keyboard interface for 4 x RS 232C input
- For simultaneous connection of up to 4 devices
- Power supply via USB interface
- No driver file for the USB interface required
- The USB interface reveal themselves as a keyboard
- Terminators like Enter or Tab can be adjusted at the USB interface
- More settings such as language, separator and timer
- Measured results can be conveyed directly e.g. to EXCEL or other text processing or statistics programs
- Data transmission via a foot switch connector, data-switch on the cable or timer



### Shipment

- With USB cable to the PC
- Cardboard box

	Ref. No.	List price Euro
Keyboard interface T-Box 302 USB	0997 778	761.00

Accessories	Ref. No.	List price Euro
Foot-switch with jack plug	1998 732	66.00
Data cable for DATA VARIABLE	1997 501	46.20
Data cable for OPTO RS232	0996 701	71.00



## 1998 blueDAT - wireless measurement data transmission



Note: The items on this page are intended for distribution within the EU



blueDAT USB receiver

The **blueDAT** system consists of a transmitter, a receiver, and the MarCom Standard software. The transmitter can be connected to any of the usual digital handheld measuring devices. The receiver is connected via a USB interface to the end device. The MarCom Standard software organizes the processing of your measurement data and offers an interface to the CAQ/MES software system and MS-Office products.



blueDAT transmitter for DATA Variable

### Advantages of wireless measurement data transmission

- Manufacturer-neutral solution
- Error-free measurement data transmission at the press of a button
- Time savings making measurements
- More freedom of movement, no irritating cable restrictions
- Measurement monitoring via transmitter ID
- Easy data tracking
- Flexible linking of digital handheld measuring devices to measurement sites
- Use of multiple measurement devices at a single measuring site
- Arrangement of multiple measuring sites in sequence
- Transmission range appr. 10 m



blueDAT transmitter for Opto RS 232

### Special advantages of **blueDAT**:

- Very long battery life
- Very cost-effective
- Future-orientated Bluetooth® Smart technology
- Extremely compact USB receiver for installation as mobile measurement stations



blueDAT transmitter for RS 232 Proximity

**Jean Louis MENEGON** - Votre représentant et Conseiller- Tél. : **06 76 08 96 83**  
E-mail: [jlouismenegon@aol.com](mailto:jlouismenegon@aol.com) - web: [www.menegon-metrologie.com](http://www.menegon-metrologie.com)



blueDAT transmitter for RS 232 Power

### Accessories

	Ref. No.	List price Euro
<b>blueDAT USB receiver incl. MarCom Standard</b>	1998 740	93.00
<b>blueDAT for DATA Variable</b>	1998 742	335.00
<b>blueDAT for RS 232 opto</b>	1998 744	335.00
<b>blueDAT for RS 232 Proximity</b>	1998 746	459.00
<b>blueDAT for RS 232 Power</b> (Power supply through data cable)	1998 748	459.00
<b>MarCom Professional</b> (Connection of more than 100 measuring instruments)	1998 710	222.00



Overview DIGI-MET® data transmission / measuring instrument



For measuring instruments	Data cables				blueDAT			
	USB 1998 720	Digimatic 1998 501	RS 232 1997 501	RS 232 Power 0997 774	DATA-Variable 1998 742	RS 232 opto 1998 744	RS 232 Proximity 1998 746	RS 232 Power 1998 748
0222								
0223						▪		
0224						▪		
0225						▪		
0907				▪				
0908				▪				
1320	▪	▪	▪		▪	▪	▪	▪
1322	▪	▪	▪		▪	▪	▪	▪
1326	▪	▪	▪		▪	▪	▪	▪
1331	▪	▪	▪		▪	▪	▪	▪
1334	▪	▪	▪		▪	▪	▪	▪
1335	▪	▪	▪		▪	▪	▪	▪
1338	▪	▪	▪		▪	▪	▪	▪
1340	▪	▪	▪		▪	▪	▪	▪
1341	▪	▪	▪		▪	▪	▪	▪
1343	▪	▪	▪		▪	▪	▪	▪
1344	▪	▪	▪		▪	▪	▪	▪
1348	▪	▪	▪		▪	▪	▪	▪
1353	▪	▪	▪		▪	▪	▪	▪
1360	▪	▪	▪		▪	▪	▪	▪
1362	▪	▪	▪		▪	▪	▪	▪
1364	▪	▪	▪		▪	▪	▪	▪
1366	▪	▪	▪		▪	▪	▪	▪
1368	▪	▪	▪		▪	▪	▪	▪
1376	▪	▪	▪		▪	▪	▪	▪
1378	▪	▪	▪		▪	▪	▪	▪
1379	▪	▪	▪		▪	▪	▪	▪
1722	▪	▪	▪		▪	▪	▪	▪
1723	▪	▪	▪		▪	▪	▪	▪
1724	▪	▪	▪		▪	▪	▪	▪
1726	▪	▪	▪		▪	▪	▪	▪
1728	▪	▪	▪		▪	▪	▪	▪
1730	▪	▪	▪		▪	▪	▪	▪
1732	▪	▪	▪		▪	▪	▪	▪
1734	▪	▪	▪		▪	▪	▪	▪
1865	▪	▪	▪		▪	▪	▪	▪

Jean Louis MENEGON - Votre représentant et Conseiller- Tél. : 06 76 08 96 83  
 E-mail: [jlouismenegon@aol.com](mailto:jlouismenegon@aol.com) - web: [www.menegon-metrologie.com](http://www.menegon-metrologie.com)



# HELIOS • PREISSER



Jean Louis MENEGON - Votre représentant et Conseiller- Tél. : 06 76 08 96 83

E-mail: [jlouismenegon@aol.com](mailto:jlouismenegon@aol.com) - web: [www.menegon-metrologie.com](http://www.menegon-metrologie.com)

# BE INSPIRED, SO YOU DON'T HAVE TO SWEAT IT OUT

Let us do the thinking and you won't even have to break into a sweat. If you need a particular product very quickly, for example, we can give you priority in our production. With the click of a mouse we are there for you online and our hotline is only as far away as your mobile phone. And we are right there when it comes to developments, new products, the needs of our partners and suggestions from our customers.

As a medium-sized company favouring Germany as our location, we know what is expected of us: quality and precision at its best, combined with service which stands out every day.



# 8. CHAPTER CALIBRATION SERVICE, ORDER NUMBER INDEX AND KEYWORD INDEX

278	Calibration service
280	Order number index
298	Keyword index





## Free initial calibration available with many of our products



All HELIOS-PREISSER measuring instruments with a  marked in the column (=Calibration), will undergo initial calibration and are supplied with a certificate at no extra charge! No separate order is required for these articles to be pre-calibrated on delivery. For all other gauges and measuring instruments, and for subsequent calibration, the following calibration services are offered. Testing is carried out in accordance with VDI / VDE / DGQ guidelines 26 ff.

## Calibration service



**Calipers / Depth gauges / Height gauges** analogue or digital (1 graduation)

Maximum measuring range mm	Ref. No.	List price Euro
150	4310 110	11.10
300	4310 115	19.80
500	4310 120	33.50
1000	4310 125	71.00
2000	4310 130	98.00
3000	4310 135	153.00

**Micrometers according to DIN 863-1**

Maximum measuring range mm	Ref. No.	List price Euro
25	4320 210	18.90
100	4320 212	25.40
200	4320 214	27.60
300	4320 220	30.60
500	4320 224	33.80
1000	4320 228	56.00

**Micrometers with interchangeable inserts** including setting standard

Maximum measuring range mm	Ref. No.	List price Euro
100	4320 810	118.00
200	4320 814	168.00
300	4320 818	180.00
400	4320 822	185.00
500	4320 826	185.00
600	4320 830	185.00
700	4320 834	236.00
800	4320 838	236.00
900	4320 842	236.00
1000	4320 846	236.00
1200	4320 850	280.00
1400	4320 854	280.00
1600	4320 858	334.00
1800	4320 862	334.00
2000	4320 866	334.00

**Setting standards for micrometers** Tolerance zone js2

Maximum nominal dimension mm	Ref. No.	List price Euro
100	4329 010	6.70
500	4329 026	15.40
1000	4329 046	30.80

**Flanged base, straight edges and knife-edge straight edges according to DIN 875** all accuracies

Maximum beam length mm	Ref. No.	List price Euro
100	4340 210	14.40
200	4340 214	15.90
500	4340 218	23.40
750	4340 222	40.00
1000	4340 226	47.70
1500	4340 230	71.00

**Protractor**

Ref. No.	List price Euro
4342 410	11.10

**Universal bevel protractor** analogue or digital (1 blade)

Ref. No.	List price Euro
4342 610	25.40

**Rules according to DIN 866 Form A / B**

Maximum length mm	Ref. No.	List price Euro
500	4350 210	29.00
1000	4350 218	47.40
1500	4350 226	71.00
2000	4350 232	92.00
3000	4350 238	129.00

Jean Louis MENEGON - Votre représentant et Conseiller- Tél. : 06 76 08 96 83

E-mail: [jlouismenegon@aol.com](mailto:jlouismenegon@aol.com) - web: [www.menegon-metrologie.com](http://www.menegon-metrologie.com)



## Calibration service

### Flat rules according to DIN 874 Part 1 all accuracies

Maximum length mm	Ref. No.	List price Euro
500	4351 610	24.20
1000	4351 618	57.00
2000	4351 628	84.00
3000	4351 638	107.00

### Knife edge rules according to DIN 874 Part 2 all accuracies

Maximum length mm	Ref. No.	List price Euro
200	4352 412	13.80
500	4352 418	21.80
1000	4352 422	41.40

### Levels

Maximum length mm	Ref. No.	List price Euro
300	4353 410	50.00

### Frame levels

Maximum length mm	Ref. No.	List price Euro
300	4353 510	70.00

### Parallel gauge blocks

Maximum nominal dimension mm	Ref. No.	List price Euro
100	4357 010	10.40
300	4357 020	30.60

### Plug gauges, GO / NOGO master gauges

Maximum diameter mm	Ref. No.	List price Euro
100	4357 610	10.60
200	4357 620	18.00

### Setting rings (master rings)

Maximum diameter mm	Ref. No.	List price Euro
100	4358 410	15.90
200	4358 420	28.00

### Snap gauges, GO and NOGO

Maximum nominal dimension mm	Ref. No.	List price Euro
100	4358 810	18.00

### Thread plug gauges, GO / NOGO thread gauges

Maximum diameter mm	Ref. No.	List price Euro
100	4359 210	22.90

### Thread master rings

Maximum diameter mm	Ref. No.	List price Euro
100	4359 410	29.30

### Indicators, analogue and digital, readings/resolution 0.01 and 0.001

Maximum measuring range mm	Ref. No.	List price Euro
12,5	4360 210	23.40
30	4360 212	33.50
50	4360 214	38.00
100	4360 218	48.80

### Dial test indicator

Ref. No.	List price Euro
4360 810	32.40



## Order number index



Ref. No.	Page	List price €	Ref. No.	Page	List price €	Ref. No.	Page	List price €
0003219	82, 83	7.10	0203501	19	46.40	0235522	39	1,220.00
0003220	82, 83	8.50	0212520	22	123.00	0235524	39	1,552.00
0003221	82, 83	10.70	0212522	22	180.00	0235526	39	2,287.00
0003222	82, 83	14.80	0212524	22	180.00	0236201	40	87.00
0003223	83	16.60	0212526	22	205.00	0236202	40	106.00
0003224	83	24.90	0212528	22	205.00	0236203	40	119.00
0003225	82, 83	32.40	0216521	23	339.00	0236204	41	221.00
0003226	82, 83	38.70	0217501	23	63.00	0236205	40	244.00
0003227	82	35.40	0217502	23	126.00	0236206	41	315.00
0003228	83	43.10	0218501	23	84.00	0236207	41	384.00
0003229	82, 83	44.30	0219503	44	277.00	0236208	40	322.00
0003230	82, 83	45.40	0220204	93	3.10	0236209	41	427.00
0003231	82	46.40	0220704	25, 93, 118, 185, 210	3.60	0236210	41	515.00
0003232	83	46.40	0220705	27	20.70	0236211	40	386.00
0003233	82, 83	56.00	0222734	50	2,473.00	0236212	41	536.00
0003234	82	62.00	0222736	50	2,967.00	0236213	41	659.00
0003235	83	67.00	0222736	50	2,967.00	0236214	40	412.00
0003236	83	57.00	0223734	50	2,638.00	0236215	41	620.00
0003237	82, 83	61.00	0223736	50	3,057.00	0236216	41	793.00
0003238	82	62.00	0224734	51	2,236.00	0236217	41	921.00
0003239	83	69.00	0224736	51	2,710.00	0236218	40	515.00
0003240	82	80.00	0225734	51	2,357.00	0236219	41	761.00
0003241	83	80.00	0225736	51	2,798.00	0236220	41	850.00
0003242	83	76.00	0228701	54	455.00	0236221	41	1,281.00
0003243	82, 83	81.00	0228702	54	633.00	0236222	40	797.00
0003244	82	91.00	0228703	54	890.00	0236224	40	1,087.00
0003245	83	101.00	0228704	54	1,050.00	0236225	41	1,314.00
0003246	82	109.00	0228724	54	2,650.00	0236226	40	1,498.00
0003247	83	125.00	0228726	54	3,150.00	0236227	41	1,828.00
0003248	83	106.00	0230501	37	135.00	0236230	40	2,477.00
0003249	82, 83	106.00	0230502	37	150.00	0236231	41	3,021.00
0003250	82	135.00	0230503	37	165.00	0236501	40	99.00
0003251	83	141.00	0230508	37	471.00	0236502	40	125.00
0003252	82, 83	152.00	0231501	37	160.00	0236503	40	135.00
0003253	82	181.00	0231502	37	175.00	0236504	41	239.00
0003254	83	236.00	0231503	37	190.00	0236505	40	286.00
0003255	82, 83	278.00	0231508	37	515.00	0236506	41	367.00
0003256	82	263.00	0234201	38	101.00	0236507	41	446.00
0003257	83	283.00	0234202	38	123.00	0236508	40	376.00
0003258	82, 83	294.00	0234203	38	132.00	0236509	41	495.00
0003259	82	340.00	0234205	38	309.00	0236510	41	591.00
0003280	205	3.90	0234208	38	387.00	0236511	40	449.00
0003281	205	4.30	0234211	38	452.00	0236512	41	559.00
0003282	205	4.50	0234214	38	515.00	0236513	41	728.00
0003283	205	5.70	0234218	38	625.00	0236514	40	466.00
0003284	205	6.30	0234222	38	999.00	0236515	41	720.00
0003285	205	7.10	0234224	38	1,292.00	0236516	41	918.00
0003286	205	8.30	0234226	38	1,886.00	0236517	41	1,077.00
0003287	205	7.90	0234501	38	119.00	0236518	40	581.00
0003288	205	17.80	0234502	38	138.00	0236519	41	883.00
0003289	205	10.70	0234503	38	151.00	0236520	41	1,114.00
0003290	205	17.80	0234505	38	350.00	0236521	41	1,522.00
0003291	205	30.80	0234508	38	451.00	0236522	40	955.00
0003292	205	34.00	0234511	38	512.00	0236524	40	1,281.00
0003293	205	34.30	0234514	38	580.00	0236525	41	1,563.00
0003294	205	38.30	0234518	38	697.00	0236526	40	1,931.00
0145110	28	158.00	0234522	38	1,138.00	0236527	41	2,315.00
0180310	21	4.00	0234524	38	1,464.00	0237201	42	112.00
0180320	21	6.50	0234526	38	2,143.00	0237202	42	132.00
0180330	21	6.50	0235201	39	127.00	0237203	42	144.00
0182501	20	32.00	0235202	39	147.00	0237204	43	245.00
0184501	14	23.20	0235203	39	155.00	0237205	42	293.00
0184505	14	30.00	0235205	39	357.00	0237206	43	363.00
0184508	14	39.00	0235208	39	435.00	0237207	43	433.00
0185500	14	18.50	0235211	39	499.00	0237208	42	372.00
0185501	14	23.20	0235214	39	572.00	0237209	43	477.00
0185505	14	30.00	0235218	39	666.00	0237210	43	563.00
0185508	14	39.00	0235222	39	1,093.00	0237211	42	435.00
0188501	15	20.10	0235224	39	1,381.00	0237212	43	582.00
0189501	15	20.10	0235226	39	2,039.00	0237213	43	708.00
0190501	19	24.30	0235501	39	136.00	0237214	42	469.00
0194501	16	24.30	0235502	39	163.00	0237215	43	680.00
0195501	16	24.30	0235503	39	174.00	0237216	43	852.00
019650105	17	23.20	0235505	39	397.00	0237217	43	981.00
019650116	17	23.20	0235508	39	488.00	0237218	42	572.00
019650516	17	33.20	0235511	39	555.00	0237219	43	822.00
0198501	18	28.00	0235514	39	639.00	0237220	43	910.00
0199501	18	28.00	0235518	39	755.00	0237221	43	1,340.00

Order number index



Ref. No.	Page	List price €	Ref. No.	Page	List price €	Ref. No.	Page	List price €
0237222	42	887.00	0250565	59	1,251.00	0286204	68	91.00
0237224	42	1,178.00	0250571	59	267.00	0286205	68	98.00
0237225	43	1,405.00	0250572	59	743.00	0286206	68	121.00
0237226	42	1,646.00	0250573	59	884.00	0286207	68	154.00
0237227	43	1,975.00	0250574	59	1,112.00	0286208	68	258.00
0237230	42	2,692.00	0250575	59	1,350.00	0286209	68	404.00
0237231	43	3,235.00	0252201	61	132.00	0286210	68	561.00
0237501	42	122.00	0252202	61	254.00	0286212	68	1,212.00
0237502	42	149.00	0252203	61	278.00	0286213	68	1,562.00
0237503	42	161.00	0252291	61	4.00	0286501	68	86.00
0237504	43	262.00	0252293	61	5.00	0286502	68	87.00
0237505	42	334.00	0253300	61	78.00	0286504	68	100.00
0237506	43	414.00	0253301	61	78.00	0286505	68	106.00
0237507	43	493.00	0253302	61	99.00	0286507	68	170.00
0237508	42	423.00	0253391	61	3.60	0286508	68	358.00
0237509	43	541.00	0258501	62	133.00	0286509	68	483.00
0237510	43	638.00	0258502	62	177.00	0286510	68	615.00
0237511	42	495.00	0258503	62	272.00	0292501	69	81.00
0237512	43	651.00	0258504	62	308.00	0292502	69	92.00
0237513	43	777.00	0258505	62	344.00	0294504	69	434.00
0237514	42	524.00	0260501	63	68.00	0294505	69	693.00
0237515	43	779.00	0260502	63	68.00	0294506	69	1,077.00
0237516	43	974.00	0262503	60	250.00	0294507	69	1,460.00
0237517	43	1,137.00	026552005	45	249.00	0300007	172	1.90
0237518	42	640.00	026652005	45	334.00	0300008	172	2.10
0237519	43	938.00	0268201	65	285.00	0300009	172	1.00
0237520	43	1,172.00	0268211	65	347.00	0300010	172	1.00
0237521	43	1,582.00	0268518	63	150.00	0300011	172	1.90
0237522	42	1,042.00	0268522	63	180.00	0300013	172	9.40
0237524	42	1,371.00	0273731	81	190.00	0300014	172	3.30
0237525	43	1,655.00	0273732	81	195.00	0300102	172	5.20
0237526	42	2,077.00	0273735	81	200.00	0300103	172	5.20
0237527	43	2,460.00	0273738	81	224.00	0300112	172	4.30
0238503	44	350.00	0273741	81	272.00	0300114	172	8.10
0238508	44	500.00	0273745	81	476.00	0300120	172	11.80
0238514	44	669.00	0273746	81	519.00	0300130	172	3.20
0238518	44	783.00	0273751	81	340.00	0301001	173	6.70
0238524	44	2,031.00	0273752	81	345.00	0301002	173	7.70
0238526	44	2,365.00	0273755	81	350.00	0301003	173	8.50
0250101	59	5.50	0273758	81	368.00	0301004	173	11.80
0250102	59	11.00	0273761	81	414.00	0301005	173	14.30
0250103	59	15.00	0273765	81	581.00	0301006	173	38.70
0250201	59	55.00	0273766	81	625.00	0301007	173	55.00
0250202	59	79.00	0276711	72	5.90	0301008	173	72.00
0250501	58	236.00	0279722	74, 77	251.00	0301009	173	101.00
0250502	58	642.00	0279723	74, 77	263.00	0301010	173	148.00
0250503	58	761.00	0280501	66	49.00	0302001	173	9.90
0250504	58	961.00	0281201	66	75.00	0302002	173	10.90
0250505	58	1,167.00	0281202	66	78.00	0302003	173	11.60
0250511	58	254.00	0281204	66	87.00	0302004	173	15.20
0250512	58	674.00	0281205	66	98.00	0302005	173	19.90
0250513	58	801.00	0281501	66	82.00	0302006	173	56.00
0250514	58	1,030.00	0281502	66	85.00	0302007	173	68.00
0250515	58	1,251.00	0281504	66	97.00	0302008	173	88.00
0250521	58	254.00	0281505	66	106.00	0302009	173	122.00
0250522	58	674.00	0282201	67	66.00	0302010	173	169.00
0250523	58	801.00	0282202	67	68.00	0303001	178	6.50
0250524	58	1,030.00	0282203	67	79.00	0303002	178	7.10
0250525	58	1,251.00	0282204	67	76.00	0303003	178	8.10
0250531	58	254.00	0282205	67	83.00	0303004	178	8.70
0250532	58	674.00	0282206	67	93.00	0303005	178	9.90
0250533	58	801.00	0282207	67	128.00	0303006	178	12.10
0250534	58	1,030.00	0282208	67	197.00	0303007	178	15.00
0250535	58	1,251.00	0282209	67	325.00	0303008	178	22.70
0250541	58	254.00	0282210	67	462.00	0303009	178	32.70
0250542	58	674.00	0282212	67	1,128.00	0303010	178	60.00
0250543	58	801.00	0282213	67	1,482.00	0303012	178	525.00
0250544	58	1,030.00	0282501	67	72.00	0303015	178	557.00
0250545	58	1,251.00	0282502	67	76.00	0303020	178	594.00
0250551	59	254.00	0282503	67	86.00	0304001	178	6.50
0250552	59	674.00	0282504	67	83.00	0304002	178	7.10
0250553	59	801.00	0282505	67	91.00	0304003	178	8.10
0250554	59	1,030.00	0282507	67	141.00	0304004	178	8.70
0250555	59	1,251.00	0282508	67	215.00	0304005	178	9.90
0250561	59	254.00	0282509	67	357.00	0304006	178	12.10
0250562	59	674.00	0282510	67	506.00	0304007	178	15.00
0250563	59	801.00	0286201	68	79.00	0304008	178	22.70
0250564	59	1,030.00	0286202	68	81.00	0304009	178	32.70

## Order number index



Ref. No.	Page	List price €	Ref. No.	Page	List price €	Ref. No.	Page	List price €
0304010	178	60.00	0319103	183	70.00	0369105	190	22.10
0304012	178	525.00	0319104	183	89.00	0369106	190	30.60
0304015	178	557.00	0319510	183	37.00	0369107	190	39.30
0304020	178	594.00	0320001	183	42.50	0369108	190	96.00
0306001	173	12.60	0320002	183	82.00	0369109	190	118.00
0306003	173	14.30	0320101	183	66.00	0369110	190	234.00
0306005	173	22.30	0320102	183	104.00	0369111	190	434.00
0308201	177	87.00	0321301	181	21.00	0369112	190	774.00
0308202	177	104.00	0321302	181	23.50	0369202	190	16.10
0308303	177	127.00	0321303	181	24.00	0369203	190	17.60
0308305	177	150.00	0321305	181	45.50	0369204	190	23.40
0310101	174	3.20	0322501	182	24.00	0369205	190	35.40
0310102	174	3.50	0322503	182	37.50	0369206	190	47.10
0310103	174	3.90	0322510	182	4.20	0369207	190	65.00
0310105	174	4.30	0323308	181	15.60	0369208	190	125.00
0310107	174	5.50	0323318	181	19.90	0369209	190	173.00
0310108	174	6.50	0331011	187	105.00	0369210	190	291.00
0311101	174	3.20	0331030	187	123.00	0369211	190	543.00
0311102	174	3.70	0331111	187	137.00	0369212	190	1,019.00
0311103	174	4.30	0331130	187	156.00	0370102	192	9.40
0311105	174	5.20	0334101	187	69.00	0370103	192	10.50
0311107	174	6.30	0334102	187	115.00	0370104	192	10.70
0311108	174	6.70	0334105	187	84.00	0370105	192	17.40
0311120	174	2.10	0334106	187	127.00	0370106	192	23.20
0311121	174	17.60	0338354	187	135.00	0370107	192	28.30
0312101	179	3.20	0338357	187	175.00	0370108	192	77.00
0312103	179	4.50	0343501	180	245.00	0370109	192	113.00
0312105	179	5.50	0343503	180	276.00	0370110	192	158.00
0312107	179	6.70	0344501	180	120.00	0370111	192	353.00
0312108	179	8.10	0344502	180	153.00	0370112	192	598.00
0313101	179	3.20	0344503	180	194.00	0370202	192	13.00
0313103	179	4.50	0344505	180	412.00	0370203	192	15.80
0313105	179	5.50	0345522	184	359.00	0370204	192	21.60
0313107	179	6.70	0345530	184	449.00	0370205	192	28.70
0313108	179	8.10	0345534	184	619.00	0370206	192	43.10
0314002	177	71.00	0345722	185	519.00	0370207	192	52.00
0314003	177	81.00	0345730	185	649.00	0370208	192	155.00
0314004	177	85.00	0345734	185	899.00	0370209	192	191.00
0314005	177	90.00	0345910	184, 185	115.00	0370210	192	323.00
0314102	177	108.00	0345912	184, 185	127.00	0370211	192	500.00
0314103	177	128.00	0347522	184	459.00	0370212	192	809.00
0314104	177	132.00	0347530	184	579.00	0371102	192	7.10
0314105	177	137.00	0347534	184	799.00	0371103	192	7.50
0316110	175	7.10	0347722	185	639.00	0371104	192	9.00
0316111	175	28.00	0347730	185	799.00	0371105	192	12.30
0316151	175	115.00	0347734	185	1,099.00	0371106	192	18.70
0316152	175	145.00	0349722	186	549.00	0371107	192	22.10
0316153	175	175.00	0349730	186	699.00	0371108	192	56.00
0316154	175	225.00	0349734	186	949.00	0371109	192	79.00
0316201	175	130.00	0349910	186	105.00	0371110	192	109.00
0316202	175	180.00	0349912	186	123.00	0371111	192	241.00
0317001	176	60.00	0349914	186	137.00	0371112	192	413.00
0317002	176	85.00	0349916	186	156.00	0371202	192	8.70
0317003	176	110.00	0368102	190	14.80	0371203	192	10.50
0317004	176	150.00	0368103	190	17.20	0371204	192	14.80
0317005	176	346.00	0368104	190	26.10	0371205	192	20.50
0317006	176	562.00	0368105	190	33.40	0371206	192	29.80
0317007	176	750.00	0368106	190	48.30	0371207	192	36.40
0317010	176	7.50	0368107	190	65.00	0371208	192	120.00
0317101	176	72.00	0368108	190	142.00	0371209	192	150.00
0317102	176	97.00	0368109	190	208.00	0371210	192	248.00
0317103	176	125.00	0368110	190	297.00	0371211	192	455.00
0317104	176	163.00	0368111	190	508.00	0371212	192	734.00
0317105	176	376.00	0368112	190	911.00	0372102	193	7.30
0317106	176	592.00	0368202	190	22.10	0372103	193	8.20
0317107	176	780.00	0368203	190	23.90	0372104	193	10.70
0317110	176	22.10	0368204	190	41.00	0372105	193	13.70
0318201	182	142.00	0368205	190	59.00	0372106	193	18.60
0318203	182	151.00	0368206	190	86.00	0372107	193	23.40
0318210	182	12.00	0368207	190	96.00	0372108	193	39.30
0318211	182	39.00	0368208	190	180.00	0372109	193	52.00
0319001	183	34.00	0368209	190	249.00	0372110	193	70.00
0319002	183	42.50	0368210	190	371.00	0372111	193	89.00
0319003	183	61.00	0368211	190	636.00	0372112	193	122.00
0319004	183	82.00	0368212	190	1,350.00	0372113	193	438.00
0319010	183	3.60	0369102	190	9.70	0372114	193	705.00
0319101	183	43.50	0369103	190	10.90	0373102	193	5.20
0319102	183	51.00	0369104	190	13.40	0373103	193	6.00



## Order number index



Ref. No.	Page	List price €	Ref. No.	Page	List price €	Ref. No.	Page	List price €
0373104	193	8.20	0387204	199	38.70	0396445	203	12.40
0373105	193	9.90	0388102	197	18.70	0396446	203	16.00
0373106	193	13.70	0388103	197	22.10	0396453	203	12.20
0373107	193	17.50	0388104	197	26.50	0396454	203	13.80
0373108	193	26.40	0388105	197	35.60	0396455	203	15.30
0373109	193	38.60	0388106	197	50.00	0396456	203	18.80
0373110	193	52.00	0388108	197	87.00	0396982	204	11.00
0373111	193	69.00	0388202	197	22.10	0396983	204	13.00
0373112	193	101.00	0388203	197	26.10	0396984	204	15.50
0373113	193	336.00	0388204	197	31.40	0397101	199	170.00
0373114	193	620.00	0388205	197	40.50	0410301	206	23.00
0374404	194	5.90	0388206	197	60.00	0410302	206	29.00
0374408	194	6.70	0388208	197	131.00	0410303	206	33.00
0374410	194	8.10	0388210	197	625.00	0410304	206	49.00
0374412	194	9.90	0390102	196	33.40	0411101	206	20.90
0374414	194	11.90	0390103	196	33.40	0411102	206	26.10
0374416	194	15.00	0390104	196	38.70	0411103	206	32.70
0374418	194	20.00	0390105	196	49.40	0411104	206	43.30
0374420	194	27.00	0390106	196	66.00	0411105	206	65.00
0374424	194	32.00	0390108	196	112.00	0411106	206	76.00
0374428	194	49.00	0390202	196	44.30	0411107	206	100.00
0374430	194	170.00	0390203	196	50.00	0411108	206	129.00
0374432	194	250.00	0390204	196	64.00	0411109	206	137.00
0375404	194	4.70	0390205	196	82.00	0411110	206	142.00
0375408	194	4.90	0390206	196	103.00	0411301	206	23.20
0375410	194	5.30	0390208	196	158.00	0411302	206	29.80
0375412	194	6.40	0391102	196	52.00	0411303	206	33.20
0375414	194	7.00	0391103	196	52.00	0411304	206	47.60
0375416	194	9.60	0391104	196	67.00	0411305	206	95.00
0375418	194	10.60	0391105	196	85.00	0411306	206	120.00
0375420	194	13.00	0391106	196	115.00	0411307	206	130.00
0375424	194	15.50	0391108	196	167.00	0411308	206	136.00
0375428	194	20.00	0391202	196	62.00	0411309	206	143.00
0375430	194	80.00	0391203	196	69.00	0411310	206	176.00
0375432	194	120.00	0391204	196	79.00	0412201	207	32.70
0376102	195	11.40	0391205	196	101.00	0412202	207	35.40
0376103	195	12.10	0391206	196	129.00	0412203	207	36.40
0376104	195	15.20	0391208	196	210.00	0412204	207	51.00
0376105	195	25.00	0394101	198	195.00	0413301	207	22.00
0376112	195	10.60	0394104	198	35.40	0413302	207	23.00
0376113	195	11.30	0394110	197	79.00	0415301	208	60.00
0376114	195	13.70	0395102	201	25.90	0415302	208	93.00
0376115	195	19.20	0395103	201	28.70	0415303	208	126.00
0376116	195	23.70	0395104	201	38.70	0415304	208	173.00
0376117	195	28.20	0395106	201	18.20	0415305	208	196.00
0380103	202	28.70	0395107	201	19.90	0416301	208	120.00
0380104	202	33.90	0395108	201	28.70	0416302	208	157.00
0380105	202	42.10	0395122	201	24.40	0416303	208	203.00
0380106	202	48.70	0395123	201	28.00	0416304	208	336.00
0380107	202	64.00	0395124	201	37.50	0416305	208	390.00
0380108	202	242.00	0395126	201	17.50	0417608	211	115.00
0380109	202	430.00	0395127	201	19.50	0420121	210	15.00
0385102	191	23.40	0395128	201	27.50	0420122	210	58.00
0385103	191	24.90	0395132	200	8.00	0420124	210	67.00
0385104	191	29.80	0395133	200	10.20	0420201	210	52.00
0385105	191	44.60	0395134	200	12.30	0420202	210	56.00
0385106	191	62.00	0395136	200	8.00	0420203	210	60.00
0385108	191	108.00	0395137	200	10.20	0420206	210	17.00
0385202	191	32.40	0395138	200	12.30	0420207	210	17.80
0385203	191	36.00	0395142	200	17.60	0420208	210	18.00
0385204	191	44.60	0395143	200	19.90	0422501	209	125.00
0385205	191	59.00	0395144	200	26.10	0422502	209	135.00
0385206	191	76.00	0395146	200	13.00	0422503	209	140.00
0385208	191	112.00	0395147	200	17.60	0422504	209	145.00
0386102	191	17.60	0395148	200	23.90	0425211	210	26.50
0386103	191	19.00	0396290	203	89.00	0425212	210	29.80
0386104	191	23.20	0396414	202	14.20	0425213	210	33.40
0386105	191	28.70	0396416	202	16.90	0425214	210	47.10
0386106	191	37.10	0396418	202	20.00	0425701	209	985.00
0386108	191	71.00	0396420	202	25.00	0425702	209	990.00
0386202	191	22.30	0396426	202	30.00	0425703	209	995.00
0386203	191	25.30	0396432	204	9.00	0451101	217	23.90
0386204	191	29.80	0396433	204	11.20	0451102	217	55.00
0386205	191	38.70	0396434	204	13.70	0451103	217	98.00
0386206	191	50.00	0396435	204	17.50	0451104	217	136.00
0386208	191	99.00	0396436	204	19.50	0451105	217	281.00
0387200	199	16.60	0396443	203	9.70	0451106	217	510.00
0387201	199	16.60	0396444	203	11.50	0451201	217	42.30

## Order number index



Ref. No.	Page	List price €	Ref. No.	Page	List price €	Ref. No.	Page	List price €
0451202	217	97.00	0460221	214	1.00	0465207	220	1,637.00
0451203	217	144.00	0460222	214	1.00	0465208	220	2,411.00
0451204	217	253.00	0460223	214	1.40	0465209	220	4,421.00
0451205	217	510.00	0460224	214	1.40	0466101	219	20.50
0451206	217	922.00	0460225	214	3.90	0466102	219	36.00
0452101	217	16.00	0460226	214	8.50	0466103	219	41.00
0452103	217	32.00	0460227	214	3.00	0466104	219	79.00
0452104	217	47.00	0460228	214	7.10	0466105	219	107.00
0452105	217	76.00	0460229	214	14.80	0466106	219	237.00
0452106	217	139.00	0460230	214	23.90	0466107	219	370.00
0452107	217	153.00	0460231	214	28.70	0466108	219	879.00
0452108	217	293.00	0460232	214	66.00	0466109	219	1,323.00
0452109	217	526.00	0460233	214	103.00	0466201	220	35.40
0452201	217	25.00	0460241	214	1.00	0466202	220	62.00
0452203	217	55.00	0460242	214	1.00	0466203	220	90.00
0452204	217	93.00	0460243	214	1.40	0466204	220	189.00
0452205	217	148.00	0460244	214	1.40	0466205	220	318.00
0452206	217	283.00	0460245	214	3.90	0466206	220	528.00
0452207	217	294.00	0460246	214	8.50	0466207	220	755.00
0452208	217	528.00	0460247	214	3.00	0466208	220	1,405.00
0452209	217	1,007.00	0460248	214	7.10	0466209	220	2,106.00
0453422	215	8.20	0460249	214	14.80	0467011	222	598.00
0453430	215	12.20	0460250	214	23.90	0467012	222	855.00
0453434	215	18.00	0460251	214	28.70	0467013	222	1,113.00
0454424	218	8.70	0460252	214	66.00	0467014	222	1,433.00
0454428	218	10.80	0460253	214	103.00	0467015	222	2,398.00
0454434	218	21.50	0460501	215	2.50	0467016	222	3,334.00
0454438	218	39.00	0460502	215	3.90	0467017	222	5,787.00
0454440	218	59.00	0460504	215	4.50	0467111	222	440.00
0454444	218	156.00	0460505	215	9.90	0467112	222	593.00
0455424	218	16.00	0460506	215	20.10	0467113	222	791.00
0455428	218	19.90	0460507	215	5.20	0467114	222	1,083.00
0455434	218	37.80	0460508	215	10.90	0467115	222	1,458.00
0455438	218	67.00	0460509	215	22.70	0467116	222	1,919.00
0455440	218	99.00	0460510	215	66.00	0467117	222	3,041.00
0455444	218	209.00	0460511	215	104.00	0478012	223	159.00
0458102	216	35.40	0460512	215	218.00	0478015	223	278.00
0458103	216	42.30	0460521	215	2.50	0478016	223	350.00
0458104	216	55.00	0460522	215	3.90	0478017	223	453.00
0458105	216	65.00	0460524	215	4.50	0478018	223	556.00
0458106	216	79.00	0460525	215	9.90	0478019	223	689.00
0458107	216	90.00	0460526	215	20.10	0478021	223	864.00
0458108	216	223.00	0460527	215	5.20	0478024	223	1,235.00
0458109	216	240.00	0460528	215	10.90	0478027	223	1,935.00
0458110	216	278.00	0460529	215	22.70	0478112	223	125.00
0458111	216	433.00	0464101	219	61.00	0478115	223	206.00
0458112	216	446.00	0464102	219	87.00	0478116	223	278.00
0458113	216	450.00	0464103	219	136.00	0478117	223	350.00
0458114	216	456.00	0464104	219	229.00	0478118	223	391.00
0458115	216	467.00	0464105	219	411.00	0478119	223	504.00
0458116	216	478.00	0464106	219	699.00	0478121	223	556.00
0458117	216	613.00	0464107	219	1,072.00	0478124	223	926.00
0458202	216	63.00	0464108	219	1,843.00	0478127	223	1,646.00
0458203	216	80.00	0464109	219	2,291.00	0478312	224	93.00
0458204	216	97.00	0464201	220	96.00	0478315	224	149.00
0458205	216	128.00	0464202	220	131.00	0478316	224	180.00
0458206	216	155.00	0464203	220	247.00	0478317	224	216.00
0458207	216	181.00	0464204	220	411.00	0478318	224	278.00
0458252	216	265.00	0464205	220	760.00	0478319	224	412.00
0458253	216	277.00	0464206	220	1,323.00	0478321	224	453.00
0458254	216	296.00	0464207	220	2,341.00	0478324	224	648.00
0458255	216	340.00	0464208	220	4,175.00	0478327	224	1,029.00
0458256	216	370.00	0464209	220	5,279.00	0478907	224	242.00
0458257	216	439.00	0465101	219	29.80	0478908	224	242.00
0458258	216	510.00	0465102	219	49.40	0478909	224	260.00
0458291	216	398.00	0465103	219	66.00	0478911	224	272.00
0460201	214	1.00	0465104	219	122.00	0478914	224	306.00
0460202	214	1.00	0465105	219	247.00	0478917	224	398.00
0460204	214	1.40	0465106	219	464.00	0481023	225	291.00
0460205	214	3.90	0465107	219	796.00	0481024	225	421.00
0460206	214	8.50	0465108	219	1,287.00	0481025	225	632.00
0460207	214	3.00	0465109	219	2,230.00	0481028	225	1,050.00
0460208	214	7.10	0465201	220	55.00	0481030	225	1,199.00
0460209	214	14.80	0465202	220	84.00	0481034	225	1,979.00
0460210	214	23.90	0465203	220	151.00	0481043	225	247.00
0460211	214	28.70	0465204	220	237.00	0481044	225	361.00
0460212	214	66.00	0465205	220	558.00	0481045	225	536.00
0460213	214	103.00	0465206	220	850.00	0481048	225	900.00

Order number index



Ref. No.	Page	List price €	Ref. No.	Page	List price €	Ref. No.	Page	List price €
0481050	225	1,141.00	0522113	229	32.00	0595110	238	12.20
0481054	225	1,799.00	0524101	229	172.00	0595115	238	3.50
0481103	225	212.00	0524102	229	257.00	0595130	235	2.90
0481104	225	307.00	0524103	229	386.00	0595140	235	2.50
0481105	225	468.00	0525101	230	111.00	0595142	235	2.50
0481108	225	780.00	0525102	230	118.00	0595251	238	84.00
0481110	225	1,038.00	0525103	230	126.00	0597301	64, 239	162.00
0481114	225	1,651.00	0527101	230	314.00	0597305	64, 239	162.00
0481160	226	326.00	0527102	230	435.00	0598101	240	45.00
0481161	226	338.00	0527104	230	617.00	0598103	240	45.00
0481162	226	356.00	0527105	230	862.00	0598105	240	45.00
0481165	226	380.00	0527107	230	372.00	0598601	240	45.00
0481167	226	398.00	0527108	230	519.00	0599101	240	45.00
0481170	226	452.00	0527110	230	792.00	0599102	240	55.00
0481184	226	1,057.00	0527111	230	1,026.00	0599151	240	6.50
0481186	226	1,164.00	0536201	231	361.00	0599152	240	6.50
0481188	226	1,208.00	0536202	231	404.00	0600101	241	23.90
0481190	226	1,350.00	0536211	231	504.00	0600102	241	29.80
0482101	224	450.00	0536212	231	596.00	0600103	241	32.00
0504012	227	86.00	0536213	231	601.00	0600111	241	51.00
0504013	227	134.00	0536220	231	95.00	0600112	241	67.00
0504014	227	206.00	0536230	231	130.00	0600113	241	141.00
0504112	227	61.00	0544101	226	320.00	0600114	241	218.00
0504113	227	81.00	0544102	226	493.00	0600115	241	351.00
0504114	227	134.00	0544103	226	682.00	0601103	241	84.00
0504312	227	42.10	0544104	226	862.00	0601120	241	64.00
0504313	227	62.00	0544105	226	1,467.00	0604002	241	6.30
0504314	227	102.00	0544106	226	2,210.00	0604004	241	6.90
0508011	228	268.00	0544107	226	4,217.00	0604006	241	6.90
0508012	228	323.00	0550021	232	230.00	0604013	242	49.00
0508013	228	498.00	0550022	232	250.00	0604014	242	49.00
0508111	228	225.00	0550023	232	265.00	0604015	242	49.00
0508112	228	280.00	0550024	232	315.00	0604016	242	49.00
0508113	228	425.00	0550101	232	165.00	0604017	242	49.00
0512101	221	9.70	0550102	232	170.00	0604018	242	49.00
0512102	221	10.90	0550103	232	180.00	0604019	242	49.00
0512103	221	12.30	0550104	232	205.00	0604020	242	49.00
0512104	221	14.00	0550131	232	125.00	0604021	242	49.00
0512105	221	18.20	0550132	232	150.00	0604022	242	49.00
0512106	221	34.30	0550133	232	160.00	0604023	242	49.00
0512107	221	61.00	0550134	232	185.00	0604024	242	49.00
0512108	221	96.00	0551002	232	260.00	0604025	242	31.80
0512201	221	12.60	0551003	232	310.00	0604026	242	31.80
0512202	221	14.80	0551012	232	165.00	0604027	242	31.80
0512203	221	15.40	0551013	232	185.00	0604028	242	31.80
0512204	221	17.20	0551021	232	155.00	0604029	242	31.80
0512205	221	19.90	0556022	233	425.00	0604030	242	31.80
0512206	221	43.30	0556023	233	480.00	0604031	242	31.80
0512207	221	79.00	0556024	233	690.00	0604032	242	31.80
0512208	221	107.00	0556101	233	265.00	0604033	242	31.80
0512209	221	207.00	0556102	233	310.00	0604034	242	31.80
0512210	221	420.00	0556103	233	380.00	0604035	242	31.80
0512211	221	550.00	0556104	233	615.00	0604036	242	31.80
0512601	221	5.00	0556131	233	215.00	0604037	242	33.40
0512602	221	5.00	0556132	233	265.00	0604038	242	33.40
0512603	221	5.00	0556133	233	415.00	0604039	242	33.40
0512604	221	6.00	0556134	233	495.00	0604040	242	33.40
0512605	221	7.00	0560001	233	283.00	0604041	242	33.40
0512606	221	8.00	0563001	233	385.00	0604042	242	33.40
0512607	221	10.00	0580101	234	6.80	0604043	242	33.40
0512608	221	15.00	0580111	234	9.90	0604044	242	33.40
0512609	221	15.00	0580121	234	6.90	0604045	242	33.40
0512610	221	30.00	0580151	234	2.90	0604046	242	33.40
0512611	221	35.00	0581101	236	19.90	0604047	242	35.20
0513001	227	139.00	0581103	236	13.50	0604048	242	35.20
0513002	227	159.00	0581105	236	18.50	0604049	242	35.20
0513011	227	149.00	0581123	236	9.70	0604050	242	35.20
0513012	227	175.00	0581125	236	8.50	0604051	242	35.20
0520101	228	123.00	0582110	236	46.00	0604052	242	35.20
0520102	228	162.00	0582120	236	46.00	0604053	242	35.20
0520103	228	215.00	0582130	237	46.00	0604054	242	35.20
0520104	228	299.00	0584101	244	293.00	0604055	242	35.20
0520105	228	409.00	0589101	237	15.60	0604056	242	35.20
0522101	229	189.00	0589103	237	47.60	0604057	242	36.70
0522102	229	230.00	0590101	237	1.60	0604058	242	36.70
0522103	229	332.00	0590111	237	60.00	0604059	242	36.70
0522111	229	19.00	0590151	238	3.20	0604060	242	36.70
0522112	229	25.00	0595101	239	19.50	0604061	242	36.70

## Order number index



Ref. No.	Page	List price €	Ref. No.	Page	List price €	Ref. No.	Page	List price €
0604062	242	36.70	0611502	245	24.00	0613338	246	63.00
0604063	242	36.70	0611503	245	8.30	0613342	246	63.00
0604064	242	36.70	0611504	245	8.30	0613346	246	71.00
0604065	242	36.70	0611505	245	6.30	0613350	246	81.00
0604066	242	36.70	0611506	245	6.50	0613352	246	97.00
0604067	242	40.00	0611507	245	6.50	0613354	246	97.00
0604068	242	40.00	0611508	245	6.50	0613356	246	116.00
0604069	242	40.00	0611509	245	6.50	0613358	246	116.00
0604070	242	40.00	0611510	245	5.60	0613360	246	133.00
0604071	242	40.00	0611512	245	5.60	0613412	246	99.00
0604072	242	40.00	0611515	245	5.60	0613418	246	80.00
0604073	242	40.00	0611518	245	7.30	0613424	246	80.00
0604074	242	40.00	0611520	245	5.60	0613430	246	76.00
0604075	242	40.00	0611525	245	5.60	0613434	246	76.00
0604076	242	40.00	0611530	245	5.60	0613438	246	95.00
0604077	242	48.50	0611535	245	5.60	0613440	246	95.00
0604078	242	48.50	0611540	245	6.50	0613442	246	95.00
0604079	242	48.50	0611545	245	6.50	0613446	246	105.00
0604080	242	48.50	0611550	245	6.50	0613450	246	123.00
0604081	242	48.50	0611552	245	8.30	0613512	246	98.00
0604082	242	48.50	0611554	245	8.30	0613518	246	79.00
0604083	242	48.50	0611556	245	8.30	0613524	246	79.00
0604084	242	48.50	0611558	245	8.30	0613530	246	75.00
0604085	242	48.50	0611560	245	8.30	0613534	246	75.00
0604086	242	48.50	0611562	245	8.30	0613538	246	93.00
0604087	242	52.00	0611564	245	8.50	0613540	246	93.00
0604088	242	55.00	0611566	245	8.90	0613542	246	93.00
0604089	242	58.00	0611568	245	8.90	0613546	246	104.00
0604090	242	66.00	0611570	245	8.90	0613550	246	122.00
0604091	242	66.00	0613107	246	63.00	0613607	247	63.00
0604092	242	66.00	0613109	246	33.90	0613609	247	33.90
0604093	242	66.00	0613114	246	23.90	0613614	247	23.90
0604094	242	66.00	0613116	246	23.90	0613616	247	23.90
0604095	242	66.00	0613118	246	23.90	0613618	247	23.90
0604096	242	66.00	0613120	246	16.30	0613620	247	16.30
0604202	241	8.30	0613122	246	16.30	0613622	247	16.30
0604204	241	10.30	0613126	246	16.30	0613626	247	16.30
0604206	241	10.30	0613128	246	16.30	0613628	247	16.30
0605101	243	2.30	0613130	246	16.80	0613630	247	16.80
0605102	243	2.10	0613134	246	16.80	0613632	247	16.80
0605103	243	2.10	0613138	246	16.80	0613634	247	16.80
0605104	243	2.10	0613142	246	16.80	0613636	247	16.80
0605105	243	3.20	0613146	246	18.70	0613638	247	16.80
0605106	243	3.40	0613150	246	18.70	0613640	247	16.80
0605107	243	4.70	0613152	246	29.80	0613642	247	16.80
0605108	243	2.80	0613154	246	29.80	0613644	247	18.70
0605109	243	3.00	0613156	246	29.80	0613646	247	18.70
0605110	243	2.80	0613158	246	29.80	0613648	247	18.70
0605111	243	2.80	0613160	246	29.80	0613650	247	18.70
0605112	243	3.20	0613207	246	90.00	0613652	247	29.80
0606121	243	1.40	0613209	246	48.70	0613654	247	29.80
0606123	243	1.40	0613214	246	34.30	0613656	247	29.80
0606127	243	1.40	0613216	246	34.30	0613658	247	29.80
0606130	243	2.30	0613218	246	34.30	0613660	247	29.80
0606131	243	5.70	0613220	246	23.40	0613709	247	46.70
0606132	243	2.80	0613222	246	23.40	0613718	247	28.30
0606133	243	5.20	0613226	246	23.40	0613730	247	26.50
0606136	243	4.70	0613228	246	23.40	0613734	247	26.50
0606150	244	3.20	0613230	246	24.30	0613738	247	33.40
0606152	244	3.80	0613232	246	24.30	0613742	247	33.40
0606154	244	5.50	0613234	246	24.30	0613746	247	37.70
0606160	244	8.20	0613236	246	24.30	0613750	247	43.10
0606162	244	9.40	0613238	246	24.30	0613752	247	52.00
0606170	244	9.90	0613240	246	24.30	0613754	247	52.00
0606172	244	12.50	0613242	246	24.30	0613756	247	63.00
0606176	244	16.60	0613244	246	26.50	0613758	247	63.00
0606178	244	24.20	0613246	246	26.50	0613760	247	69.00
0607201	243	3.60	0613248	246	26.50	0613812	247	52.00
0607202	243	5.70	0613250	246	26.50	0613818	247	42.10
0607203	243	8.10	0613252	246	43.10	0613824	247	42.10
0607401	243	6.10	0613254	246	43.10	0613830	247	39.80
0607402	243	7.50	0613256	246	43.10	0613834	247	39.80
0607403	243	10.70	0613258	246	43.10	0613838	247	49.80
0611180	245	140.00	0613260	246	43.10	0613840	247	49.80
0611190	245	185.00	0613309	246	87.00	0613842	247	49.80
0611195	245	2.50	0613318	246	52.00	0613846	247	58.00
0611300	245	73.00	0613330	246	49.40	0613850	247	67.00
0611501	245	28.90	0613334	246	49.40	0613860	247	109.00

## Order number index



Ref. No.	Page	List price €	Ref. No.	Page	List price €	Ref. No.	Page	List price €
0613912	247	52.00	0623410	249	35.00	0624210	248	22.00
0613918	247	41.60	0623415	249	35.00	0624215	248	22.00
0613924	247	41.60	0623420	249	35.00	0624220	248	22.00
0613930	247	39.50	0623425	249	35.00	0624225	248	22.00
0613934	247	39.50	0623430	249	35.00	0624230	248	22.00
0613938	247	49.40	0623435	249	35.00	0624235	248	22.00
0613940	247	49.40	0623440	249	35.00	0624240	248	22.00
0613942	247	49.40	0623445	249	35.00	0624245	248	22.00
0613946	247	58.00	0623450	249	35.00	0624250	248	22.00
0613950	247	66.00	0623455	249	35.00	0624255	248	22.00
0623100	248	39.00	0623460	249	35.00	0624260	249	22.00
0623102	248	33.00	0623465	249	35.00	0624265	249	22.00
0623104	248	33.00	0623470	249	35.00	0624270	249	22.00
0623106	248	33.00	0623475	249	42.00	0624275	249	22.00
0623108	248	33.00	0623500	249	42.00	0624280	249	22.00
0623110	248	33.00	0623510	249	42.00	0624285	249	22.00
0623112	248	33.00	0623520	249	42.00	0624290	249	22.00
0623114	248	33.00	0623530	249	42.00	0624295	249	22.00
0623116	248	33.00	0623540	249	42.00	0624300	249	22.00
0623118	248	33.00	0623550	249	42.00	0624305	249	22.00
0623120	248	33.00	0623560	249	42.00	0624310	249	22.00
0623122	248	33.00	0623570	249	42.00	0624315	249	22.00
0623130	248	33.00	0623580	250	42.00	0624320	249	22.00
0623135	248	33.00	0623590	250	42.00	0624325	249	22.00
0623140	248	33.00	0623600	250	42.00	0624330	249	22.00
0623145	248	33.00	0623610	250	42.00	0624335	249	22.00
0623150	248	33.00	0623620	250	42.00	0624340	249	22.00
0623155	248	33.00	0623630	250	42.00	0624345	249	22.00
0623160	248	33.00	0623640	250	42.00	0624350	249	22.00
0623165	248	33.00	0623650	250	50.00	0624355	249	22.00
0623170	248	33.00	0623660	250	50.00	0624360	249	22.00
0623175	248	33.00	0623670	250	50.00	0624365	249	22.00
0623180	248	33.00	0623680	250	50.00	0624370	249	22.00
0623185	248	33.00	0623690	250	50.00	0624375	249	22.00
0623190	248	33.00	0623700	250	50.00	0624380	249	22.00
0623195	248	33.00	0623710	250	62.00	0624385	249	22.00
0623200	248	33.00	0623720	250	62.00	0624390	249	22.00
0623205	248	33.00	0623730	250	74.00	0624395	249	22.00
0623210	248	33.00	0623740	250	262.00	0624400	249	23.00
0623215	248	33.00	0623750	250	262.00	0624405	249	23.00
0623220	248	33.00	0623760	250	262.00	0624410	249	23.00
0623225	248	33.00	0623770	250	312.00	0624415	249	23.00
0623230	248	33.00	0623780	250	446.00	0624420	249	23.00
0623235	248	33.00	0623790	250	578.00	0624425	249	23.00
0623240	248	33.00	0623800	250	800.00	0624430	249	23.00
0623245	248	33.00	0623810	250	1,249.00	0624435	249	23.00
0623250	248	33.00	0623820	250	1,295.00	0624440	249	23.00
0623255	248	33.00	0623830	250	1,600.00	0624445	249	23.00
0623260	249	33.00	0623840	250	1,896.00	0624450	249	23.00
0623265	249	33.00	0623850	250	2,350.00	0624455	249	23.00
0623270	249	33.00	0624100	248	26.00	0624460	249	23.00
0623275	249	33.00	0624102	248	22.00	0624465	249	23.00
0623280	249	33.00	0624104	248	22.00	0624470	249	23.00
0623285	249	33.00	0624106	248	22.00	0624475	249	28.00
0623290	249	33.00	0624108	248	22.00	0624500	249	28.00
0623295	249	33.00	0624110	248	22.00	0624510	249	28.00
0623300	249	33.00	0624112	248	22.00	0624520	249	28.00
0623305	249	33.00	0624114	248	22.00	0624530	249	28.00
0623310	249	33.00	0624116	248	22.00	0624540	249	28.00
0623315	249	33.00	0624118	248	22.00	0624550	249	28.00
0623320	249	33.00	0624120	248	22.00	0624560	249	28.00
0623325	249	33.00	0624122	248	22.00	0624570	249	28.00
0623330	249	33.00	0624130	248	22.00	0624580	250	28.00
0623335	249	33.00	0624135	248	22.00	0624590	250	28.00
0623340	249	33.00	0624140	248	22.00	0624600	250	28.00
0623345	249	33.00	0624145	248	22.00	0624610	250	28.00
0623350	249	33.00	0624150	248	22.00	0624620	250	28.00
0623355	249	33.00	0624155	248	22.00	0624630	250	28.00
0623360	249	33.00	0624160	248	22.00	0624640	250	28.00
0623365	249	33.00	0624165	248	22.00	0624650	250	33.00
0623370	249	33.00	0624170	248	22.00	0624660	250	33.00
0623375	249	33.00	0624175	248	22.00	0624670	250	33.00
0623380	249	33.00	0624180	248	22.00	0624680	250	33.00
0623385	249	33.00	0624185	248	22.00	0624690	250	33.00
0623390	249	33.00	0624190	248	22.00	0624700	250	33.00
0623395	249	33.00	0624195	248	22.00	0624710	250	41.00
0623400	249	35.00	0624200	248	22.00	0624720	250	41.00
0623405	249	35.00	0624205	248	22.00	0624730	250	49.00



## Order number index



Ref. No.	Page	List price €	Ref. No.	Page	List price €	Ref. No.	Page	List price €
0624740	250	159.00	0625400	249	18.00	0633153	253	226.00
0624750	250	159.00	0625405	249	18.00	0633154	253	319.00
0624760	250	159.00	0625410	249	18.00	0633155	253	414.00
0624770	250	189.00	0625415	249	18.00	0633170	253	179.00
0624780	250	270.00	0625420	249	18.00	0633171	253	74.00
0624790	250	350.00	0625425	249	18.00	0633172	253	301.00
0624800	250	485.00	0625430	249	18.00	0633173	253	98.00
0624810	250	675.00	0625435	249	18.00	0633174	254	168.00
0624820	250	700.00	0625440	249	18.00	0633175	254	197.00
0624830	250	865.00	0625445	249	18.00	0633176	254	310.00
0624840	250	1,025.00	0625450	249	18.00	0633177	254	366.00
0624850	250	1,270.00	0625455	249	18.00	0633178	254	179.00
0625100	248	21.00	0625460	249	18.00	0633179	254	227.00
0625102	248	18.00	0625465	249	18.00	0633180	254	272.00
0625104	248	18.00	0625470	249	18.00	0633181	254	404.00
0625106	248	18.00	0625475	249	22.00	0633182	254	132.00
0625108	248	18.00	0625500	249	22.00	0633214	252	399.00
0625110	248	18.00	0625510	249	22.00	0633216	252	315.00
0625112	248	18.00	0625520	249	22.00	0633218	252	216.00
0625114	248	18.00	0625530	249	22.00	0633220	252	142.00
0625116	248	18.00	0625540	249	22.00	0633805	255	313.00
0625118	248	18.00	0625550	249	22.00	0633808	255	419.00
0625120	248	18.00	0625560	249	22.00	0633810	255	254.00
0625122	248	18.00	0625570	249	22.00	0633833	255	520.00
0625130	248	18.00	0625580	250	22.00	0633834	255	694.00
0625135	248	18.00	0625590	250	22.00	0633836	255	1,239.00
0625140	248	18.00	0625600	250	22.00	0634014	256	4,224.00
0625145	248	18.00	0625610	250	22.00	0634016	256	3,480.00
0625150	248	18.00	0625620	250	22.00	0634017	256	2,274.00
0625155	248	18.00	0625630	250	22.00	0634020	256	1,194.00
0625160	248	18.00	0625640	250	22.00	0634114	256	3,718.00
0625165	248	18.00	0625650	250	26.00	0634116	256	3,039.00
0625170	248	18.00	0625660	250	26.00	0634117	256	2,038.00
0625175	248	18.00	0625670	250	26.00	0634120	256	1,037.00
0625180	248	18.00	0625680	250	26.00	0634514	257	5,898.00
0625185	248	18.00	0625690	250	26.00	0634516	257	4,697.00
0625190	248	18.00	0625700	250	26.00	0634517	257	2,801.00
0625195	248	18.00	0625710	250	33.00	0634520	257	1,701.00
0625200	248	18.00	0625720	250	33.00	0634614	257	4,937.00
0625205	248	18.00	0625730	250	39.00	0634616	257	3,924.00
0625210	248	18.00	0625740	250	127.00	0634617	257	2,341.00
0625215	248	18.00	0625750	250	127.00	0634620	257	1,419.00
0625220	248	18.00	0625760	250	127.00	0636301	258	750.00
0625225	248	18.00	0625770	250	136.00	0636321	258	227.00
0625230	248	18.00	0625780	250	215.00	0636322	258	227.00
0625235	248	18.00	0625790	250	252.00	0636323	258	281.00
0625240	248	18.00	0625800	250	330.00	0636324	258	281.00
0625245	248	18.00	0625810	250	410.00	0636325	258	281.00
0625250	248	18.00	0625820	250	490.00	0636326	258	343.00
0625255	248	18.00	0625830	250	606.00	0636327	258	343.00
0625260	249	18.00	0625840	250	718.00	0636328	258	343.00
0625265	249	18.00	0625850	250	889.00	0636329	258	343.00
0625270	249	18.00	0633001	254	290.00	0636341	258	955.00
0625275	249	18.00	0633014	251	821.00	0636342	258	955.00
0625280	249	18.00	0633016	251	750.00	0636343	258	1,210.00
0625285	249	18.00	0633018	251	488.00	0636344	258	1,210.00
0625290	249	18.00	0633020	251	356.00	0636345	258	1,210.00
0625295	249	18.00	0633114	251	631.00	0636346	258	1,489.00
0625300	249	18.00	0633116	251	481.00	0636347	258	1,489.00
0625305	249	18.00	0633118	251	297.00	0636348	258	1,489.00
0625310	249	18.00	0633120	251	217.00	0636349	258	1,489.00
0625315	249	18.00	0633130	252	1,064.00	0636351	258	1,220.00
0625320	249	18.00	0633131	252	1,235.00	0636352	258	1,109.00
0625325	249	18.00	0633132	252	1,598.00	0636372	258	668.00
0625330	249	18.00	0633133	252	3,156.00	0636373	258	668.00
0625335	249	18.00	0633136	253	148.00	0636374	258	880.00
0625340	249	18.00	0633137	253	168.00	0636375	258	880.00
0625345	249	18.00	0633138	253	200.00	0636376	258	880.00
0625350	249	18.00	0633139	253	182.00	0636377	258	1,065.00
0625355	249	18.00	0633140	253	217.00	0636378	258	1,208.00
0625360	249	18.00	0633141	253	251.00	0636379	258	1,208.00
0625365	249	18.00	0633142	253	285.00	0636380	258	1,208.00
0625370	249	18.00	0633143	253	309.00	0636392	259	12.20
0625375	249	18.00	0633144	253	360.00	0636393	259	14.00
0625380	249	18.00	0633145	253	503.00	0636394	259	26.50
0625385	249	18.00	0633150	253	170.00	0636395	259	34.00
0625390	249	18.00	0633151	253	170.00	0636396	259	39.20
0625395	249	18.00	0633152	253	185.00	0637103	260	28.70

Order number index



Ref. No.	Page	List price €	Ref. No.	Page	List price €	Ref. No.	Page	List price €
0637104	260	28.70	0649210	262	79.00	0656353	264	88.00
0637105	260	28.70	0649211	262	79.00	0656354	264	96.00
0637106	260	20.90	0649212	262	86.00	0656355	264	100.00
0637107	260	20.90	0649213	262	86.00	0656356	264	104.00
0637108	260	18.70	0649215	262	95.00	0656357	264	107.00
0637109	260	18.70	0649216	262	109.00	0656358	264	114.00
0637110	260	18.70	0649217	262	109.00	0656359	264	122.00
0637111	260	17.60	0649219	262	130.00	0656360	264	126.00
0637112	260	17.60	0649220	262	169.00	0656361	264	131.00
0637113	260	18.70	0649222	262	194.00	0656362	264	135.00
0637114	260	18.70	0649223	262	194.00	0656363	264	142.00
0637115	260	19.90	0650101	263	844.00	0656364	264	147.00
0637116	260	20.90	0650102	263	922.00	0656365	264	155.00
0637117	260	20.90	0650103	263	1,013.00	0656366	264	166.00
0637118	260	22.10	0650104	263	1,110.00	0656367	264	176.00
0637119	260	23.20	0650105	263	1,599.00	0656368	264	182.00
0637120	260	23.20	0650106	263	1,809.00	0656369	264	190.00
0637121	260	23.90	0650107	263	2,075.00	0656370	264	202.00
0637122	260	23.90	0650108	263	2,161.00	0656371	264	212.00
0637123	260	24.90	0650109	263	2,293.00	0656372	264	218.00
0637124	260	25.90	0650110	263	2,481.00	0656373	264	229.00
0637125	260	25.90	0650111	263	2,663.00	0656374	264	241.00
0637126	260	25.90	0650112	263	2,846.00	0656375	264	251.00
0637127	260	27.20	0650113	263	3,030.00	0656376	264	263.00
0637128	260	27.80	0650114	263	3,274.00	0656377	264	274.00
0637129	260	28.70	0650115	263	4,183.00	0656378	264	284.00
0637130	260	28.70	0650116	263	4,363.00	0656379	264	295.00
0637131	260	29.80	0650117	263	4,553.00	0656380	264	306.00
0637132	260	31.00	0650118	263	4,739.00	0656381	264	317.00
0637133	260	31.00	0650119	263	4,924.00	0656382	264	328.00
0637134	260	32.00	0656303	264	46.40	0656383	264	358.00
0637135	260	32.00	0656304	264	69.00	0656384	264	387.00
0637136	260	35.40	0656305	264	825.00	0656385	264	416.00
0637137	260	36.00	0656306	264	908.00	0656386	264	447.00
0637138	260	37.10	0656309	264	53.00	0656387	264	476.00
0637139	260	37.10	0656310	264	46.40	0656388	264	505.00
0637140	260	37.90	0656311	264	46.40	0656389	264	536.00
0637141	260	38.70	0656312	264	46.40	0656390	264	564.00
0637142	260	39.80	0656313	264	45.40	0656391	264	595.00
0637144	260	41.00	0656314	264	44.30	0656392	264	624.00
0637146	260	42.30	0656315	264	44.30	0656393	264	657.00
0637147	260	52.00	0656316	264	44.30	0656394	264	686.00
0637148	260	45.40	0656317	264	44.30	0656395	264	719.00
0637149	260	46.40	0656318	264	44.30	0656396	264	751.00
0637150	261	47.10	0656319	264	45.40	0656397	264	783.00
0637151	261	49.40	0656320	264	46.40	0656398	264	815.00
0637152	261	50.00	0656321	264	47.10	0656399	264	846.00
0637154	261	52.00	0656322	264	47.10	0658001	265	137.00
0637155	261	55.00	0656323	264	48.30	0658002	265	132.00
0637156	261	58.00	0656324	264	48.30	0658003	265	115.00
0637157	261	62.00	0656325	264	49.40	0658004	265	100.00
0637158	261	64.00	0656326	264	49.40	0658005	265	88.00
0637159	261	67.00	0656327	264	50.00	0658006	265	88.00
0637160	261	67.00	0656328	264	52.00	0658007	265	81.00
0637161	261	74.00	0656329	264	52.00	0658008	265	76.00
0637162	261	75.00	0656330	264	52.00	0658009	265	63.00
0637163	261	77.00	0656331	264	55.00	0658010	265	62.00
0637164	261	81.00	0656332	264	56.00	0658011	265	59.00
0637165	261	85.00	0656333	264	57.00	0658012	265	58.00
0637166	261	86.00	0656334	264	58.00	0658013	265	56.00
0637167	261	88.00	0656335	264	58.00	0658014	265	57.00
0637168	261	91.00	0656336	264	59.00	0658015	265	58.00
0637169	261	96.00	0656337	264	55.00	0658016	265	59.00
0637170	261	97.00	0656338	264	62.00	0658017	265	62.00
0637171	261	100.00	0656339	264	62.00	0658018	265	97.00
0637172	261	102.00	0656340	264	63.00	0658019	265	66.00
0637173	261	105.00	0656341	264	63.00	0658020	265	71.00
0637174	261	107.00	0656342	264	64.00	0658021	265	77.00
0637190	261	137.00	0656343	264	65.00	0658022	265	82.00
0649201	262	66.00	0656344	264	66.00	0658023	265	87.00
0649202	262	66.00	0656345	264	67.00	0658024	265	93.00
0649203	262	66.00	0656346	264	71.00	0658025	265	104.00
0649204	262	68.00	0656347	264	75.00	0658026	265	114.00
0649205	262	68.00	0656348	264	77.00	0658027	265	127.00
0649206	262	72.00	0656349	264	79.00	0658028	265	138.00
0649207	262	72.00	0656350	264	81.00	0658029	265	150.00
0649208	262	75.00	0656351	264	83.00	0658030	265	166.00
0649209	262	75.00	0656352	264	86.00	0658031	265	244.00

## Order number index



Ref. No.	Page	List price €	Ref. No.	Page	List price €	Ref. No.	Page	List price €
0658032	265	264.00	0658632	266	204.00	0710163	132	4.70
0658033	265	295.00	0658633	266	216.00	0710164	132	4.70
0658034	265	305.00	0658634	266	234.00	0710165	132	5.90
0658035	265	338.00	0658635	266	247.00	0710166	132	4.30
0658036	265	358.00	0658636	266	264.00	0710167	133	3.00
0658037	265	392.00	0658637	266	283.00	0710168	133	3.00
0658038	265	417.00	0658638	266	299.00	0710169	133	5.90
0658090	265	233.00	0658690	267	233.00	0710170	133	5.90
0658501	266	138.00	0691731	123	349.00	0710171	133	5.90
0658502	266	131.00	0691733	123	400.00	0710172	133	5.90
0658503	266	121.00	0691735	123	871.00	0710173	133	5.90
0658504	266	88.00	0691737	123	982.00	0710174	133	5.90
0658505	266	80.00	0691741	123	431.00	0710175	133	5.90
0658506	266	80.00	0691743	123	473.00	0710176	133	5.90
0658507	266	69.00	0691745	123	965.00	0710177	133	5.90
0658508	266	60.00	0691747	123	1,115.00	0710178	133	5.90
0658509	266	49.40	0691751	123	501.00	0710179	133	5.90
0658510	266	46.40	0691753	123	554.00	0710180	133	5.90
0658511	266	45.40	0700100	127	55.00	0710181	133	5.90
0658512	266	45.40	0700101	127	55.00	0710182	133	5.90
0658513	266	45.40	0700102	127	42.10	0710183	133	5.90
0658514	266	45.40	0700104	127	48.30	0710184	133	5.90
0658515	266	46.40	0701101	124	37.10	0710185	133	5.90
0658516	266	49.40	0701102	124	45.60	0710186	133	5.90
0658517	266	55.00	0701103	125	20.50	0710187	133	5.90
0658518	266	62.00	0701106	125	21.60	0710188	133	5.90
0658519	266	64.00	0701110	125	36.70	0710189	133	5.90
0658520	266	69.00	0701111	125	42.30	0710192	134	6.30
0658521	266	77.00	0702106	127	56.00	0710193	134	3.20
0658522	266	88.00	0703101	125	90.00	0710194	134	4.30
0658523	266	98.00	0703104	125	125.00	0710195	134	1.00
0658524	266	106.00	0703107	125	250.00	0710196	134	6.90
0658525	266	114.00	0704105	126	64.00	0710197	134	1.00
0658526	266	128.00	0704106	126	79.00	0710261	132	21.60
0658527	266	138.00	0704109	126	103.00	0710262	132	34.90
0658528	266	152.00	0704110	126	133.00	0710263	132	42.10
0658529	266	163.00	0705102	128	99.00	0710264	132	40.70
0658530	266	177.00	0705104	128	99.00	0710265	132	18.70
0658531	266	193.00	0705105	128	103.00	0710267	133	9.90
0658532	266	204.00	0705107	128	105.00	0710268	133	9.90
0658533	266	216.00	0705109	128	128.00	0710292	134	44.30
0658534	266	234.00	0706102	128	64.00	0710297	134	4.10
0658535	266	247.00	0707101	126	113.00	0710367	133	7.70
0658536	266	264.00	0707102	126	97.00	0710368	133	7.70
0658537	266	283.00	0708101	124	79.00	0710397	134	5.50
0658538	266	299.00	0708102	124	50.00	0710467	133	7.70
0658590	267	233.00	0708103	124	60.00	0710468	133	7.70
0658601	266	138.00	0708104	124	41.60	0710497	134	5.50
0658602	266	131.00	0708105	124	50.00	0712121	129	143.00
0658603	266	121.00	0708106	124	67.00	0712124	129	175.00
0658604	266	88.00	0709101	129	95.00	0715101	135	74.00
0658605	266	80.00	0709108	129	113.00	0715103	135	83.00
0658606	266	80.00	0710101	130	46.40	0715201	135	116.00
0658607	266	69.00	0710102	130	6.10	0715303	135	104.00
0658608	266	60.00	0710103	130	6.30	0715305	135	99.00
0658609	266	49.40	0710104	130	9.70	0715307	135	148.00
0658610	266	46.40	0710105	130	9.70	0715903	135	11.20
0658611	266	45.40	0710111	131	4.10	0715907	135	11.20
0658612	266	45.40	0710112	131	4.10	0715915	135	15.60
0658613	266	45.40	0710113	131	4.10	0715917	135	12.30
0658614	266	45.40	0710114	131	4.10	0715919	135	12.30
0658615	266	46.40	0710115	131	4.10	0715921	135	17.20
0658616	266	49.40	0710116	131	4.10	0715922	135	13.00
0658617	266	55.00	0710117	131	4.10	0715923	135	12.90
0658618	266	63.00	0710118	131	4.10	0715925	135	15.80
0658619	266	64.00	0710119	131	4.10	0715926	135	12.30
0658620	266	69.00	0710120	131	4.10	0715929	135	12.30
0658621	266	77.00	0710121	131	4.10	0715940	135	2.30
0658622	266	88.00	0710122	131	4.10	0715950	136	23.40
0658623	266	98.00	0710123	131	4.10	0715955	136	14.80
0658624	266	106.00	0710124	131	4.10	0716101	136	129.00
0658625	266	114.00	0710125	131	4.10	0716102	136	189.00
0658626	266	128.00	0710126	131	4.10	0716105	136	169.00
0658627	266	138.00	0710127	131	4.10	0716111	136	249.00
0658628	266	152.00	0710128	131	4.10	0716192	136	55.00
0658629	266	163.00	0710129	131	4.10	0716194	136	67.00
0658630	266	177.00	0710161	132	3.20	0716196	136	87.00
0658631	266	193.00	0710162	132	4.10	0718101	137	47.10

## Order number index



Ref. No.	Page	List price €	Ref. No.	Page	List price €	Ref. No.	Page	List price €
0718104	137	98.00	0728110	145	1,925.00	0750112	158	101.00
0718105	137	111.00	0728201	145	930.00	0750121	158	79.00
0718106	137	168.00	0728202	145	665.00	0750122	158	89.00
0718108	137	144.00	0728203	145	620.00	0750601	158	23.20
0718109	137	166.00	0728204	145	430.00	0751103	160	109.00
0718110	137	185.00	0728205	145	435.00	0751104	160	127.00
0718112	137	93.00	0728206	145	415.00	0752101	159	133.00
0718113	137	107.00	0728207	145	485.00	0752103	159	170.00
0718115	137	111.00	0728208	145	630.00	0753110	157	23.00
0720102	138	147.00	0728209	145	835.00	0753120	157	57.00
0720103	138	210.00	0728210	145	1,970.00	0754101	159	91.00
0721100	139	473.00	0728910	145	1,150.00	0756101	160	55.00
0721101	139	473.00	0728915	145	1,140.00	0763100	163	258.00
0721120	139	490.00	0728920	145	1,650.00	0770102	161	163.00
0721121	139	490.00	0735101	146	377.00	0770103	161	206.00
0721122	139	490.00	0735102	146	340.00	0770201	161	208.00
0721123	139	490.00	0735103	146	395.00	0770205	161	322.00
0721124	139	506.00	0736101	146	870.00	0772024	162	701.00
0721125	139	506.00	0736102	146	938.00	0780001	165	347.00
0721126	139	506.00	0736103	146	1,005.00	0780002	165	385.00
0721127	139	506.00	0737101	147	847.00	0780003	165	600.00
0721140	140	134.00	0737121	147	84.00	0780021	164	81.00
0721141	140	473.00	0737122	147	84.00	0780023	164	123.00
0721142	140	473.00	0737123	147	84.00	0780032	165	149.00
0721143	140	473.00	0737124	147	84.00	0780033	165	214.00
0721144	140	473.00	0739102	148	1,644.00	0780042	165	178.00
0721145	140	473.00	0739121	150	84.00	0780043	165	241.00
0721148	140	720.00	0739122	150	95.00	0780072	164	97.00
0721149	140	720.00	0739123	150	87.00	0780073	164	170.00
0721731	141	506.00	0739124	148	99.00	0780074	164	195.00
0721732	141	506.00	0739125	148	103.00	0780091	165	351.00
0721733	141	506.00	0739126	148	59.00	0780092	165	395.00
0721734	141	506.00	0739127	148	94.00	0780093	165	812.00
0721738	141	645.00	0739128	148	59.00	0780094	165	839.00
0721739	141	645.00	0739129	148	114.00	0780101	163	559.00
0721740	141	890.00	0739130	148	95.00	0780102	163	709.00
0721741	142	506.00	0739131	148	103.00	0780104	163	639.00
0721745	142	645.00	0739132	148	137.00	0780105	163	728.00
0721746	142	645.00	0739164	150	35.60	0780107	163	1,833.00
0721747	142	890.00	0739165	150	44.00	0780108	163	2,043.00
0721785	142	135.00	0739170	150	176.00	0780141	164	1,955.00
0721786	142	135.00	0741101	152	1,720.00	0780142	164	2,212.00
0724101	131	44.30	0741112	152	240.00	0782160	166	653.00
0726122	144	138.00	0741114	152	254.00	0782181	166	208.00
0726123	144	126.00	0741116	152	388.00	0782191	166	1,083.00
0726124	144	119.00	0741122	155	249.00	0783012	166	3,274.00
0726130	144	218.00	0741124	155	299.00	0783070	166	273.00
0726300	144	281.00	0741132	155	81.00	0784108	167	2,864.00
0726301	144	282.00	0741134	156	141.00	0785108	162	590.00
0726302	144	895.00	0741136	155	232.00	0785109	162	1,446.00
0726303	144	635.00	0741140	156	177.00	0785110	162	1,662.00
0726304	144	395.00	0741141	156	100.00	0788104	168	1,044.00
0726305	144	485.00	0741142	156	100.00	0788180	168	212.00
0726306	144	315.00	0741143	156	100.00	0788904	169	832.00
0726310	144	640.00	0741144	156	100.00	0788980	169	67.00
0726311	144	655.00	0741145	156	100.00	0788990	169	301.00
0726312	144	1,040.00	0741146	156	100.00	0800501	86	17.40
0726313	144	750.00	0741147	156	100.00	0800502	86	21.20
0726500	144	645.00	0741148	156	100.00	0800503	86	24.30
0726501	144	920.00	0741149	156	100.00	0800504	86	28.70
0726502	144	1,430.00	0741163	156	202.00	0800513	86	102.00
0726510	144	980.00	0741164	156	202.00	0806501	87	31.50
0726511	144	935.00	0741165	156	202.00	0806502	87	34.50
0726512	144	1,750.00	0741166	156	202.00	0806503	87	37.50
0726513	144	1,080.00	0741167	156	202.00	0806504	87	40.50
0727752	143	2,450.00	0741168	156	202.00	0806513	87	148.00
0727755	143	1,540.00	0741170	153	158.00	0806521	88	43.10
0727758	143	2,190.00	0741172	154	189.00	0806522	88	68.00
0727761	143	1,740.00	0741174	154	154.00	0806523	88	84.00
0727772	143	21.50	0741176	154	106.00	0806524	88	97.00
0727775	143	21.50	0741178	153	106.00	0806525	88	132.00
0727778	143	21.50	0741179	153	106.00	0806526	88	148.00
0727781	143	21.50	0741180	153	106.00	0806527	88	165.00
0728105	145	365.00	0741182	153	176.00	0806528	88	181.00
0728106	145	355.00	0741184	156	600.00	0806540	88	254.00
0728107	145	405.00	0750101	158	129.00	0806542	88	559.00
0728108	145	565.00	0750102	158	172.00	0807101	86	52.00
0728109	145	815.00	0750111	158	55.00	0810501	89	239.00

## Order number index



Ref. No.	Page	List price €	Ref. No.	Page	List price €	Ref. No.	Page	List price €
0810502	89	252.00	0864321	103	305.00	0886507	115	22.50
0810503	89	265.00	0864322	103	366.00	0886513	115	40.00
0810504	89	281.00	0864323	103	397.00	0888101	106	47.20
0815510	89	251.00	0864324	103	430.00	0888501	106	148.00
0815514	89	265.00	0864325	103	465.00	0888502	106	148.00
0815518	89	331.00	0864326	103	498.00	0888503	106	148.00
0815530	89	285.00	0864327	103	535.00	0888504	106	154.00
0815534	89	421.00	0864328	103	572.00	0888505	106	160.00
0815540	89	465.00	0870301	100	284.00	0888506	106	178.00
0816501	90	300.00	0870302	100	296.00	0888507	106	183.00
0816502	90	339.00	0870303	100	319.00	0888508	106	190.00
0816503	90	391.00	0870304	100	348.00	0888509	106	196.00
0816504	90	447.00	0870305	100	381.00	0888510	106	202.00
0816505	90	508.00	0870306	100	415.00	0888511	106	208.00
0816506	90	574.00	0870307	100	591.00	0888512	106	216.00
0816507	90	810.00	0870309	100	646.00	0888513	106	223.00
0816508	90	856.00	0870311	100	710.00	0888514	106	232.00
0816509	90	909.00	0870801	102	67.00	0888515	106	238.00
0816510	90	975.00	0870802	102	68.00	0888516	106	247.00
0816511	90	1,052.00	0870803	102	69.00	0888517	106	253.00
0816512	90	1,126.00	0870804	102	70.00	0888518	106	263.00
0817512	91	967.00	0870805	102	71.00	0888519	106	270.00
0817514	91	1,006.00	0870807	102	79.00	0888520	106	277.00
0817516	91	1,126.00	0870809	102	89.00	0888521	106	284.00
0817518	91	1,277.00	0870811	102	98.00	0890511	104	64.00
0817520	91	1,429.00	0870821	102	67.00	0892332	107	68.00
0817522	91	1,585.00	0870822	102	68.00	0892333	107	69.00
0817524	91	1,745.00	0870823	102	69.00	0892334	107	77.00
0817526	91	1,931.00	0870824	102	74.00	0892336	107	94.00
0817528	91	2,126.00	0870825	102	75.00	0892339	107	125.00
0817530	91	2,326.00	0870827	102	86.00	0892340	107	175.00
0817532	91	2,546.00	0870829	102	99.00	0892501	107	362.00
0817534	91	2,821.00	0870831	102	113.00	0892502	107	444.00
0817536	91	3,011.00	0870841	102	147.00	0892503	107	547.00
0817538	91	4,714.00	0870842	102	151.00	0892504	107	689.00
0817540	91	5,003.00	0870843	102	155.00	0892505	107	875.00
0817542	91	5,383.00	0870844	102	162.00	0894504	108	216.00
0817544	91	5,703.00	0870845	102	175.00	0894510	108	573.00
0817546	91	6,059.00	0870847	102	209.00	0894514	108	772.00
0817910	91	151.00	0870849	102	255.00	0894518	108	997.00
0819501	92	170.00	0870851	102	312.00	0894522	108	1,228.00
0819502	92	190.00	0870901	101	107.00	0894526	108	1,264.00
0819503	92	210.00	0870903	101	92.00	0894530	108	1,482.00
0819505	92	240.00	0870905	101	92.00	0894534	108	1,523.00
0819510	92	230.00	0870907	101	92.00	0894538	108	2,657.00
0819511	92	290.00	0870909	101	92.00	0894542	108	3,466.00
0819512	92	330.00	0870911	101	107.00	0894546	108	4,302.00
0819513	92	380.00	0870921	101	116.00	0894550	108	5,112.00
0819514	92	470.00	0870923	101	101.00	0894554	108	5,921.00
0819515	92	540.00	0870925	101	101.00	0894804	108	154.00
0819516	92	620.00	0870927	101	101.00	0894806	108	175.00
0819517	92	700.00	0870929	101	101.00	0894810	108	190.00
0819519	92	1,300.00	0870931	101	101.00	0894820	108	209.00
0819521	92	1,400.00	0870933	101	116.00	0894834	108	238.00
0819523	92	1,650.00	0870941	101	274.00	0894854	108	781.00
0819525	92	1,895.00	0870943	101	199.00	0894872	108	810.00
0819527	92	2,180.00	0870945	101	175.00	0898101	99	10.50
0822301	97	88.00	0870947	101	175.00	0898102	99	17.60
0822302	97	133.00	0870949	101	175.00	0898103	99	20.90
0822303	97	244.00	0870951	101	175.00	0898104	99	23.90
0822304	97	400.00	0870953	101	199.00	0898105	99	27.60
0824302	97	167.00	0870955	101	274.00	0898106	99	39.10
0824303	97	169.00	0882300	115	253.00	0898107	99	43.70
0849501	96	680.00	0882301	115	275.00	0898108	99	48.30
0849502	96	809.00	0882303	115	302.00	0898109	99	53.00
0850511	96	538.00	0882304	115	354.00	0898110	99	58.00
0850512	96	597.00	0882306	115	570.00	0898111	99	62.00
0850514	96	634.00	0884501	105	764.00	0898112	99	77.00
0850516	96	678.00	0885501	105	169.00	0898113	99	83.00
0850518	96	709.00	0885502	105	188.00	0898114	99	89.00
0854301	98	238.00	0885503	105	196.00	0898115	99	94.00
0854302	98	288.00	0885504	105	236.00	0898116	99	101.00
0854303	98	309.00	0885505	105	299.00	0898117	99	107.00
0854304	98	335.00	0885506	105	346.00	0898118	99	113.00
0855301	98	171.00	0885507	105	440.00	0898119	99	118.00
0855302	98	210.00	0885508	105	499.00	0898120	99	125.00
0855303	98	238.00	0886503	115	22.50	0898121	99	131.00
0855304	98	251.00	0886505	115	26.00	0898122	99	138.00

## Order number index



Ref. No.	Page	List price €	Ref. No.	Page	List price €	Ref. No.	Page	List price €
0898123	99	144.00	0907819	111	2,071.00	0908873	114	3,688.00
0898124	99	151.00	0907820	111	2,198.00	0908875	114	4,682.00
0898125	99	158.00	0907821	111	2,648.00	0909506	112, 114	78.00
0898126	99	164.00	0907822	111	2,910.00	0909508	112, 114	78.00
0898127	99	170.00	0907823	111	3,014.00	0909509	112, 114	78.00
0898128	99	177.00	0907824	111	3,284.00	0909511	112, 114	114.00
0898129	99	184.00	0907851	112	3,483.00	0909514	112, 114	134.00
0898130	99	191.00	0907853	112	1,434.00	0912501	93	75.00
0898131	99	197.00	0907855	112	1,719.00	0912502	93	85.00
0898132	99	204.00	0907857	112	2,341.00	0912503	93	97.00
0898133	99	209.00	0907859	112	2,594.00	0912504	93	111.00
0898134	99	216.00	0907861	112	2,189.00	0912505	93	122.00
0898135	99	223.00	0907863	112	2,901.00	0912506	93	134.00
0898136	99	230.00	0907875	112	4,512.00	0912507	93	144.00
0898137	99	236.00	0908701	113	1,640.00	0912508	93	155.00
0898138	99	243.00	0908702	113	1,640.00	0912521	93	401.00
0898139	99	250.00	0908703	113	1,640.00	0932701	95	455.00
0898140	99	256.00	0908704	113	1,640.00	0932702	95	530.00
0898142	99	268.00	0908705	113	1,640.00	0932703	95	600.00
0898146	99	294.00	0908706	113	1,160.00	0932704	95	650.00
0898150	99	322.00	0908707	113	1,134.00	0932705	95	700.00
0898154	99	347.00	0908708	113	1,197.00	0932706	95	750.00
0898158	99	374.00	0908709	113	1,214.00	0932707	95	800.00
0898162	99	600.00	0908710	113	1,287.00	0932708	95	900.00
0898166	99	629.00	0908711	113	1,374.00	0932731	95	580.00
0898170	99	658.00	0908712	113	1,491.00	0932732	95	600.00
0898174	99	687.00	0908713	113	1,523.00	0932733	95	650.00
0898178	99	715.00	0908714	113	1,568.00	0932734	95	700.00
0907701	111	1,422.00	0908715	113	1,568.00	0933701	103	750.00
0907702	111	1,422.00	0908716	113	1,672.00	0933702	103	825.00
0907703	111	1,422.00	0908717	113	1,749.00	0933703	103	875.00
0907704	111	1,422.00	0908718	113	1,855.00	0933704	103	925.00
0907705	111	1,422.00	0908719	113	1,962.00	0933705	103	975.00
0907706	111	983.00	0908720	113	2,051.00	0933706	103	1,025.00
0907707	111	983.00	0908721	113	2,698.00	0933707	103	1,075.00
0907708	111	995.00	0908722	113	2,976.00	0933708	103	1,150.00
0907709	111	1,009.00	0908723	113	3,084.00	0996701	28, 95, 209, 271	71.00
0907710	111	1,009.00	0908724	113	3,404.00	0996705	28, 95, 209, 271	136.00
0907711	111	1,212.00	0908751	114	3,749.00	0997770	50, 95, 272	232.00
0907712	111	1,393.00	0908753	114	1,407.00	0997772	143, 185, 272	232.00
0907713	111	1,448.00	0908755	114	1,662.00	0997774	111, 272	283.00
0907714	111	1,611.00	0908757	114	2,177.00	0997778	272	761.00
0907715	111	1,611.00	0908759	114	2,438.00	1271451	73	82.00
0907716	111	1,698.00	0908761	114	2,177.00	1271452	73	95.00
0907717	111	1,770.00	0908763	114	2,909.00	1271455	73	55.00
0907718	111	1,825.00	0908773	114	3,613.00	1276591	79	17.30
0907719	111	1,996.00	0908775	114	4,607.00	1278912	80	105.00
0907720	111	2,123.00	0908801	113	1,715.00	1278916	80	105.00
0907721	111	2,573.00	0908802	113	1,715.00	1278920	80	105.00
0907722	111	2,835.00	0908803	113	1,715.00	1278923	80	26.00
0907723	111	2,939.00	0908804	113	1,715.00	1278924	80	26.00
0907724	111	3,209.00	0908805	113	1,715.00	1278930	80	381.00
0907751	112	3,408.00	0908806	113	1,235.00	1278936	80	26.00
0907753	112	1,359.00	0908807	113	1,209.00	1278938	80	26.00
0907755	112	1,644.00	0908808	113	1,272.00	1278940	80	26.00
0907757	112	2,266.00	0908809	113	1,289.00	1278942	80	26.00
0907759	112	2,519.00	0908810	113	1,362.00	1278944	80	26.00
0907761	112	2,114.00	0908811	113	1,449.00	1278946	80	26.00
0907763	112	2,826.00	0908812	113	1,566.00	1278948	80	26.00
0907775	112	4,437.00	0908813	113	1,598.00	1278950	80	26.00
0907801	111	1,497.00	0908814	113	1,643.00	1278952	80	26.00
0907802	111	1,497.00	0908815	113	1,643.00	1278954	80	26.00
0907803	111	1,497.00	0908816	113	1,747.00	1278956	80	26.00
0907804	111	1,497.00	0908817	113	1,824.00	1278958	80	26.00
0907805	111	1,497.00	0908818	113	1,930.00	1278960	80	26.00
0907806	111	1,058.00	0908819	113	2,037.00	1278962	80	26.00
0907807	111	1,058.00	0908820	113	2,126.00	1279780	77	105.00
0907808	111	1,070.00	0908821	113	2,773.00	1279781	77	105.00
0907809	111	1,084.00	0908822	113	3,051.00	1279782	77	105.00
0907810	111	1,084.00	0908823	113	3,159.00	1279783	77	105.00
0907811	111	1,287.00	0908824	113	3,479.00	1279784	77	105.00
0907812	111	1,468.00	0908851	114	3,824.00	1279785	77	105.00
0907813	111	1,523.00	0908853	114	1,482.00	1320416	25	105.00
0907814	111	1,686.00	0908855	114	1,737.00	1320417	25	105.00
0907815	111	1,686.00	0908857	114	2,252.00	1320516	25	137.00
0907816	111	1,773.00	0908859	114	2,513.00	1320517	25	137.00
0907817	111	1,845.00	0908861	114	2,252.00	1320518	25	370.00
0907818	111	1,900.00	0908863	114	2,984.00	1320519	25	172.00

## Order number index



Ref. No.	Page	List price €	Ref. No.	Page	List price €	Ref. No.	Page	List price €
1320522	25	221.00	1360738	70	1,931.00	1998730	271	111.00
1322516	27	195.00	1360740	70	2,292.00	1998732	271	66.00
1326416	26	152.00	1362722	71	397.00	1998740	273	93.00
1326417	26	152.00	1362728	71	461.00	1998742	273	335.00
1326418	26	211.00	1364722	72	375.00	1998744	273	335.00
1326422	26	267.00	1364728	72	418.00	1998746	273	459.00
1326516	26	152.00	1366718	75	390.00	1998748	273	459.00
1326517	26	152.00	1366722	75	471.00	1998750	111	125.00
1326518	26	222.00	1366728	75	593.00	1998770	119	5.50
1326904	35	529.00	1368722	74	397.00	4310110	278	11.10
1326906	36	525.00	1368728	74	451.00	4310115	278	19.80
1326908	35	451.00	1371416	73	358.00	4310120	278	33.50
1326910	36	519.00	1371422	73	439.00	4310125	278	71.00
1326912	32	295.00	1371428	73	505.00	4310130	278	98.00
1326914	26	317.00	1375502	78	230.00	4310135	278	153.00
1326916	33	366.00	1376514	79	477.00	4320210	278	18.90
1326918	31	465.00	1378505	80	728.00	4320212	278	25.40
1326920	32	503.00	1378508	80	783.00	4320214	278	27.60
1326922	33	413.00	1379722	76	612.00	4320220	278	30.60
1326924	34	409.00	1379728	76	844.00	4320224	278	33.80
1326928	34	440.00	1722502	118	133.00	4320228	278	56.00
1326930	31	603.00	1723502	118	167.00	4320810	278	118.00
1326932	29	339.00	1724502	118	273.00	4320814	278	168.00
1330522	46	370.00	1726502	119	319.00	4320818	278	180.00
1330528	46	561.00	1726506	119	351.00	4320822	278	185.00
1330532	46	916.00	1726510	119	618.00	4320826	278	185.00
1330534	46	1,109.00	1726514	119	765.00	4320830	278	185.00
1331522	46	426.00	1728502	119	267.00	4320834	278	236.00
1331528	46	629.00	1728506	119	340.00	4320838	278	236.00
1331532	46	969.00	1728510	119	554.00	4320842	278	236.00
1331534	46	1,114.00	1728514	119	709.00	4320846	278	236.00
1334522	47	341.00	1730502	120	353.00	4320850	278	280.00
1334528	47	478.00	1730506	120	398.00	4320854	278	280.00
1334532	47	836.00	1732502	120	298.00	4320858	278	334.00
1334534	47	989.00	1732506	120	376.00	4320862	278	334.00
1335522	47	390.00	1734502	121	367.00	4320866	278	334.00
1335528	47	551.00	1734506	121	421.00	4329010	278	6.70
1335532	47	899.00	1734522	122	475.00	4329026	278	15.40
1335534	47	1,033.00	1739910	119	37.00	4329046	278	30.80
1338522	53	439.00	1739920	118	13.80	4340210	278	14.40
1340522	48	398.00	1865510	94	181.00	4340214	278	15.90
1340528	48	759.00	1865513	94	234.00	4340218	278	23.40
1340532	48	1,025.00	1865517	94	321.00	4340222	278	40.00
1340534	48	1,261.00	1865520	94	370.00	4340226	278	47.70
1341522	48	450.00	1920574	110	1,040.00	4340230	278	71.00
1341528	48	811.00	1920576	110	730.00	4342410	278	11.10
1341532	48	1,076.00	1920578	110	1,800.00	4342610	278	25.40
1341534	48	1,312.00	1920580	110	2,150.00	4350210	278	29.00
1342522	49	366.00	1920910	110	85.00	4350218	278	47.40
1342528	49	676.00	1920914	110	90.00	4350226	278	71.00
1342532	49	935.00	1920920	110	95.00	4350232	278	92.00
1342534	49	1,163.00	1920924	110	115.00	4350238	278	129.00
1343522	49	418.00	1921510	109	370.00	4351610	279	24.20
1343528	49	728.00	1921512	109	370.00	4351618	279	57.00
1343532	49	987.00	1921514	109	370.00	4351628	279	84.00
1343534	49	1,214.00	1921516	109	370.00	4351638	279	107.00
1348722	56	561.00	1921518	109	390.00	4352412	279	13.80
1348728	56	719.00	1921520	109	400.00	4352418	279	21.80
1351522	52	512.00	1921522	109	405.00	4352422	279	41.40
1351528	52	662.00	1921524	109	455.00	4353410	279	50.00
1351622	52	546.00	1921526	109	455.00	4353510	279	70.00
1351628	52	724.00	1921528	109	525.00	4357010	279	10.40
1351920	55	461.00	1921530	109	540.00	4357020	279	30.60
1352516	62	358.00	1921532	109	555.00	4357610	279	10.60
1352517	62	403.00	1921534	109	570.00	4357620	279	18.00
1352518	62	739.00	1921536	109	800.00	4358410	279	15.90
1352520	62	832.00	1921538	109	945.00	4358420	279	28.00
1352522	62	867.00	1921540	109	995.00	4358810	279	18.00
1353522	60	453.00	1921542	109	1,050.00	4359210	279	22.90
1354520	55	545.00	1997501	25, 94, 118, 270	46.20	4359410	279	29.30
1360716	70	304.00	1998501	25, 94, 118, 270	59.00	4360210	279	23.40
1360718	70	345.00	1998710	270	222.00	4360212	279	33.50
1360722	70	387.00	1998712	270	56.00	4360214	279	38.00
1360728	70	445.00	1998720	25, 94, 118, 270	66.00	4360218	279	48.80
1360734	70	1,266.00	1998722	271	56.00	4360810	279	32.40







[www.menegon-metrologie.com](http://www.menegon-metrologie.com)



**Jean Louis MENEGON** - Votre représentant et Conseiller- Tél. : 06 76 08 96 83  
E-mail: [jlouismenegon@aol.com](mailto:jlouismenegon@aol.com) - web: [www.menegon-metrologie.com](http://www.menegon-metrologie.com)



## **WE ARE AN APPROVED TRAINING COMPANY**

Our trainees are an important part of our corporate structure, because we rely on qualified and motivated employees.

**Jean Louis MENEGON** - Votre représentant et Conseiller- Tél. : **06 76 08 96 83**  
E-mail: [jlouismenegon@aol.com](mailto:jlouismenegon@aol.com) - web: [www.menegon-metrologie.com](http://www.menegon-metrologie.com)



## Keyword index



0 - 9	Seite	D	Seite
2/3 point internal micrometers, analogue	109	Dial micrometers	96
2/3 point internal micrometers, digital	111	Dial test indicators and accessories	135
2/3 point internal measuring pistol, digital	113	Dial thickness gauges	137, 138
<b>A</b>		Digital pocket calipers	25
Acute angle squares 45°	201	Digital pocket calipers for specific measuring tasks	31-36
Adjustable squares	204	Digital pocket calipers IP65	26
Adjustable V-blocks	230	Digital pocket calipers IP67	26
Alpha square	203	Digital pocket calipers PRISMA	27
Aluminium straight edges	215	DIN thread conversion	236
Angle lever attachment	131	Disc micrometer to measure gear tooth, analogue & digital	103
Angle normal 90°	226	Disc micrometers	97
<b>B</b>		Dividers	173, 174
Base stand for inspection plates	224	Double V-blocks	229
Base stand for surface and inspection plates	226	Drill and steel wire hole gauges	241
Batteries for electronic devices	25, 93, 119	»Duo-Fix« pocket vernier caliper	19
Beam compass	176	<b>E</b>	
Beam trammel	175	Extension depth attachment base for depth gauges	73, 74, 77
Bench centres & accessories	163-165	Extensions for dial gauges	131
Bench centre with granite work bench & accessories	166	»Extensions« measuring tool set for pocket calipers	28
Bevel protractors	208-210	External caliper gauges, analogue	140
Blade micrometers	98	External caliper gauges, digital	142
Box for data input	272	External calipers	178, 179
Brake disc inspection gauges	61	<b>F</b>	
Brake drum vernier calipers	61	Feeler gauge tapes	245
<b>C</b>		Feeler gauges	243, 244
Cabinets for measuring and inspection plates	226	»Filetor« ISO thread convertor	236
Cable for data transmission	274	Flange squares	202
Calibration service	278, 279	Flexible steel rules	214, 215
Calipers for 3/5 point measurement	63	Frame levels	233
Calipers for external locking grooves, analogue & digital	60	<b>G</b>	Seite
Calipers for internal grooves, analogue & digital	62	Gauge block accessories sets	252
Calipers with cross points, analogue & digital	45, 52, 55	Gauge block holders	253
Calipers with gripper points analogue & digital	45, 55	Gauge block inspection sets for micrometers and calipers	255
Calipers, analogue	14-23, 37-45, 58-65	Gauge block maintenance set	254
Calipers, digital	25-36, 46-57, 60, 62	Gauge blocks	248
Carbide gauge block sets	256	Gear tooth calipers	65
Carpenters squares	203	<b>H</b>	
Centre points	253	Height and scribing gauges	184
Centre squares	202	Height and scribing gauges, digital	185, 186
Ceramic gauge block sets	257	Holder for dial gauges / lever gauges	136
Chamfer gauge	64, 239	Holder for external micrometers	86
Combined internal / external calipers	177	Holder for feeler gauge tapes	245
Compact measuring stands	161	Holder for internal micrometers	106
Concentricity measuring gauge with disc supports	167	<b>I</b>	
Connecting cables for electronic instruments	28	Indicators	118-123
Contraction vernier calipers	58, 59	Inspection plates	223, 224
Convertor mm/inch	237	Inspection points	253
Crankpin levels	232	Inspection set for micrometers and calipers	255
Crankshaft gauges	146	Inspection square set	199
Cutting gauges	234, 235	Inspection squares, hardened	191
<b>D</b>		Interchangeable inserts for depth caliper	77
Data acquisition / data transmission	270-273	Interior circumference tapes	216
Data cables	274	Internal caliper gauges, analogue	139
DBP weld seam gauge	238	Internal caliper gauges, digital	141
Depth attachment base for pocket calipers	27	Internal calipers	178, 179
Depth gauge, digital, with interchangeable inserts	76	Internal micrometers with extensions	108
Depth gauges, digital	70-80	Internal micrometers with interchangeable extensions	107
Depth measuring base for indicators	136	Internal micrometers with measuring jaws	105
Depth micrometers	115	Internal micrometers, cylindrical version	106
Depthgauge, digital, for one-hand operation	80	Internal precision bore gauges	144, 145
Dial calipers	23	<b>K</b>	
Dial comparator gauges »MICROTAST«	129	Knife edge jaws	254
Dial depth gauges with a measuring base	136	Knife edge rule	221
Dial gauges, analogue	124-129	Knife edge squares, hardened	196, 197, 199
Dial gauges, shockproof	126	<b>L</b>	
Dial gauges, shockproof, error free	128	Lapping and inspection plate	224
Dial gauges, small	124	Length measuring instrument for external incisions	146
Dial gauges, water and oil proof	126	Length measuring instrument for internal incisions	147
Dial gauges, with concentric mm-display	127	Levels	232, 233
Dial gauges, with extended measuring range	125	Lightweight workshop calipers, analogue & digital	44, 54
Dial gauges, with reverse action plunger	129		

## Keyword index



L	Seite	S	Seite
Lug back	130	Spring dividers	174
<b>M</b>		Squares with hard and slim	195, 196
Machine levels with V-groove	230	Squares with base	190-194
Magnetic angle gauge	159, 160	Squares without base	190-194
Magnetic back	157-159	Stand for gaugeblock holders	254
Magnetic base	232	Steel gauge block, sets	251-252
Magnetic indicator stands	215, 217, 218	Steel rules	219, 220
Magnetic indicator stands with flexible arm	225	Steel rules, flexible	214, 215
Magnetic measuring and clamping prism	27	Steel scale tapes for circumference and diameter	216
Marking calipers	73, 74, 77	Steel square	194
Marking gauges	101	Straight edges with bevelled edge	218
Measuring and inspection plates	132-134	Surface roughness standards	244
Measuring inserts for dial gauges	240	<b>T</b>	Seite
Measuring stands	14-23, 37-45, 58-65	Tapered hole gauges	240, 241
Measuring tool set »Extensions«	25-36, 46-57, 60, 62	Tapes for circumference and diameter	216
Measuring tool sets	63	Thread cutting gauges	234, 235
Micrometers for thread flank measurement	45, 55	Thread flank inserts for external measurement	101
Micrometers for tube wall measurement	45, 52, 55	Thread flank setting standards for external measurement	102
Micrometers with reduced measuring faces	115	Thread plug gauges, individual and set	265
Micrometers, external, analogue	163	Thread ring gauges, individual and set	266, 267
Micrometers, external, digital	168, 169	»Tolerator« ISO tolerance convertor	236
Micrometers, external, with exchangeable anvils	161, 162	Twist drill grinding gauges	237
Micrometers, external, with interchangeable inserts	129	Tyre profile depth gauge	21
Milling tool caliper	126	<b>U</b>	
Mitre squares	124-128	»Uhrstast« comparator gauge & accessories	151-156
Mounting scales, digital	118-123	Universal bevel protractors, analogue & digital	209, 210
Mounting straight edges	125	Universal calipers, digital, Pocket-Talent	29, 56
<b>N</b>		Universal comparator gauge & accessories	148-150
Nozzle gauges	240	Universal grinding gauge	238
<b>P</b>		Universal indicator stands & magnetic base & accessories	157, 158
Parallel blocks, set	231	Universal magnetic holder	159, 160
Pattern maker angle	197, 198	Universal measuring support	163
Pin gauge holder	259	USB Keyboard interfaces	272
Pin gauges, set	258	<b>V</b>	
Plane parallel jaws	254	V-blocks	227-230
Plug gauges, individual and set	260, 261	Vernier depth gauges	66-69
Pocket calipers	21	<b>W</b>	
»POCKET-TALENT«	29	Wall holders with feelergauge tape sets	245
Pocket vernier caliper »Duo-Fix«	19	Welding gauges	238, 239
Pocket vernier caliper »PRISMA«	19	Wire thickness micrometer	104
Pocket vernier caliper, for lefthanded	20	Wireless data transmission	273
Pocket vernier calipers	14-20	Wooden cases	82, 83, 205, 221
Pocket vernier calipers, parallax-free reading	18	Workshop caliper, dial	44
Precision feeler gauge tapes	246	Workshop calipers, analogue	37-43
Precision reference sheets	247	Workshop calipers, analogue, long measuring jaws	43
»PRISMA« calipers	19, 53	Workshop calipers, digital	46-54
Profile gauge	237	Workshop calipers, digital, »PRISMA«	53
Protractor »PERNUMETER«	211	Workshop calipers, parallax-free reading	37
Protractor level	233	<b>X</b>	
Protractors	206-211	X type V-blocks (parallel)	228
<b>R</b>			
Radius gauge	64, 239, 241		
Radius gauges, individual	242		
Radiused measuring jaws	253		
Ring gauges	264		
Roller supports for bench centre	165, 166		
<b>S</b>			
Screw pitch gauges	243		
Scribers	172, 253		
Set of 2/3 point internal micrometers, analogue	110		
Set of 2/3 point internal micrometers, digital	112		
Set of 2/3 point internal micrometers, measuring pistol	114		
Set of external micrometers, analogue	87, 88		
Setting device for internal precision bore gauges	145		
Setting of internal precision bore gauges, digital	143		
Setting standards for micrometers	99		
Shaft measuring instruments	168, 169		
Sine bars	227		
Sinus rules	227		
Small depth gauge, digital	78		
Snap gauges, adjustable	262, 263		
Snap gauges, double jaw	262		
Software for data acquisition	270		



[www.menegon-metrologie.com](http://www.menegon-metrologie.com)



**Jean Louis MENEGON** - Votre représentant et Conseiller- Tél. : 06 76 08 96 83  
E-mail: [jlouismenegon@aol.com](mailto:jlouismenegon@aol.com) - web: [www.menegon-metrologie.com](http://www.menegon-metrologie.com)



## **OUR PARTICULAR STRENGTH: CUSTOM MADE PRODUCTS ACCORDING TO CUSTOMER SPECIFICATIONS**

We develop and produce according to your specific requirements and industrial applications precision measuring instruments in the highest quality.

**Jean Louis MENEGON** - Votre représentant et Conseiller- Tél. : **06 76 08 96 83**  
E-mail: [jlouismenegon@aol.com](mailto:jlouismenegon@aol.com) - web: [www.menegon-metrologie.com](http://www.menegon-metrologie.com)

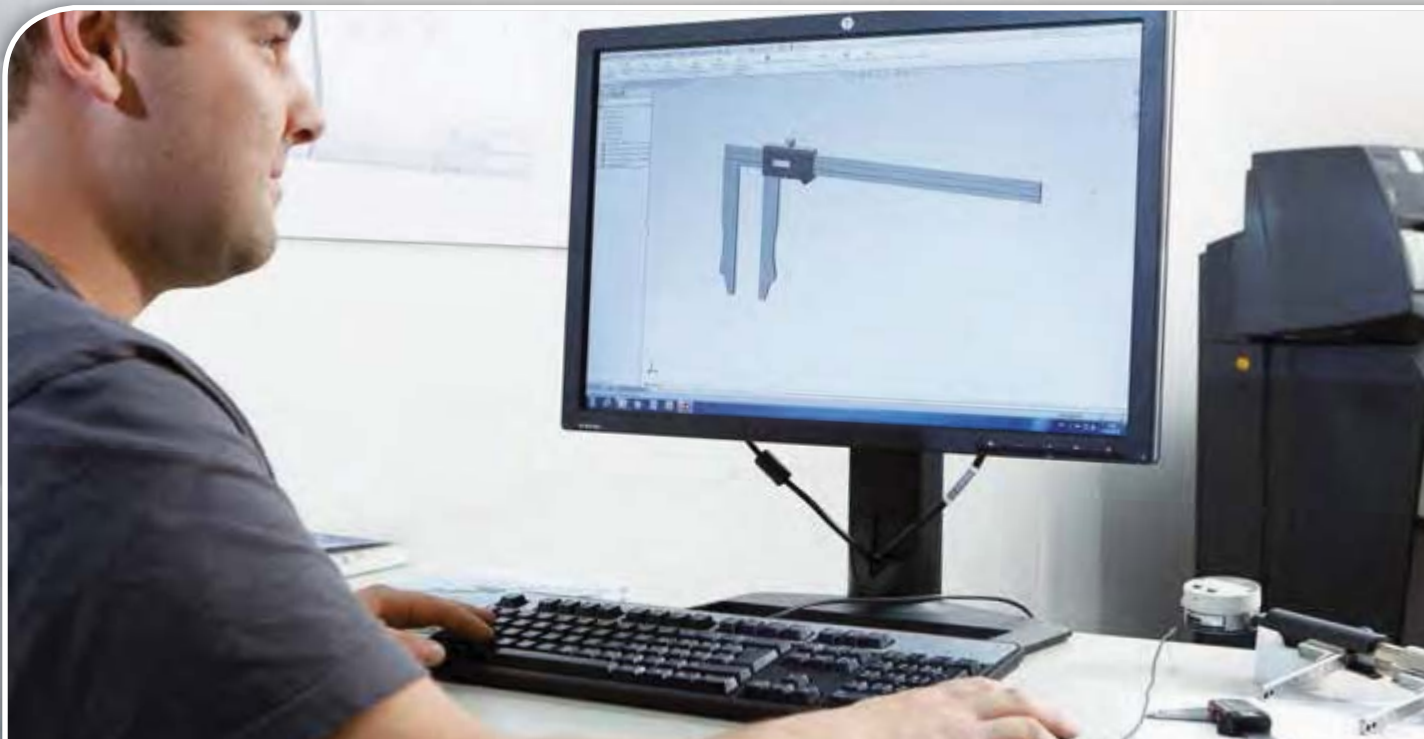







Important notes regarding this catalogue



